



Eurocode 8: Seismic Design of Buildings Worked examples

Worked examples presented at the Workshop “EC 8: Seismic Design of Buildings”, Lisbon, 10-11 Feb. 2011

Support to the implementation, harmonization and further development of the Eurocodes

**P. Bisch, E. Carvalho, H. Degee, P. Fajfar, M. Fardis, P. Franchin, M. Kreslin, A. Pecker,
P. Pinto, A. Plumier, H. Somja, G. Tsionis**



Editors
B. Acun, A. Athanasopoulou, A. Pinto
E. Carvalho, M. Fardis

EUR 25204 EN - 2012

The mission of the JRC is to provide customer-driven scientific and technical support for the conception, development, implementation and monitoring of EU policies. As a service of the European Commission, the JRC functions as a reference centre of science and technology for the Union. Close to the policy-making process, it serves the common interest of the Member States, while being independent of special interests, whether private or national.

European Commission
Joint Research Centre

Contact information

Address: JRC, ELSA Unit, TP 480, I-21020, Ispra (VA), Italy
E-mail: eurocodes@jrc.ec.europa.eu
Tel.: +39-0332-789989
Fax: +39-0332-789049

<http://www.jrc.ec.europa.eu/>

Legal Notice

Neither the European Commission nor any person acting on behalf of the Commission or any author of this report is responsible for the use which might be made of this publication.

***Europe Direct is a service to help you find answers
to your questions about the European Union***

Freephone number (*):

00 800 6 7 8 9 10 11

(*): Certain mobile telephone operators do not allow access to 00 800 numbers or these calls may be billed.

A great deal of additional information on the European Union is available on the Internet. It can be accessed through the Europa server <http://europa.eu/>

JRC 68411

EUR 25204 EN
ISBN 978-92-79-23068-4
ISSN 1831-9424
doi:10.2788/91658

Luxembourg: Publications Office of the European Union, 2012

© European Union, 2012

Reproduction is authorised provided the source is acknowledged

Printed in Italy

Acknowledgements

The work presented in this report is a deliverable within the framework of the Administrative Arrangement SI2.558935 under the Memorandum of Understanding between the Directorate-General for Enterprise and Industry of the European Commission (DG ENTR) and the Joint Research Centre (JRC) on the support to the implementation, harmonisation and further development of the Eurocodes.

Table of Contents

Acknowledgements	i
Table of Contents	iii
List of authors and editors	ix
CHAPTER 1	
Overview of Eurocode 8. Performance requirements, ground conditions and seismic action.....	1
1.1 Overview of the Eurocodes	3
1.2 Eurocode 8.....	5
1.2.1 SCOPE OF EN 1998-1	6
1.2.2 PERFORMANCE REQUIREMENTS AND COMPLIANCE CRITERIA.....	6
1.2.3 GROUND CONDITIONS	13
1.2.4 SEISMIC ACTION	15
CHAPTER 2	
Introduction to the RC building example. Modeling and analysis of the design example	25
2.1 Description of the building and of actions	27
2.1.1 DESCRIPTION OF THE BUILDING	27
2.1.2 ACTIONS	29
2.2 Structural model	31
2.2.1 GENERAL	31
2.3 Structural regularity.....	34
2.3.1 CRITERIA FOR REGULARITY IN PLAN.....	34
2.3.2 CRITERIA FOR REGULARITY IN ELEVATION	37
2.4 Structural type of the building and behaviour factor.....	37
2.5 Modal response spectrum analysis.....	38
2.5.1 GENERAL	38
2.5.2 PERIODS, EFFECTIVE MASSES AND MODAL SHAPES.....	38
2.5.3 ACCIDENTAL TORSIONAL EFFECTS	39
2.5.4 SHEAR FORCES	41
2.5.5 DISPLACEMENTS	41
2.5.6 DAMAGE LIMITATIONS	42

2.5.7 CRITERION OF THE SECOND ORDER EFFECTS.....	43
2.5.8 SEISMIC DESIGN SITUATION	44
2.5.9 INTERNAL FORCES.....	45
2.6 Lateral force method of analysis	48
2.6.1 GENERAL	48
2.6.2 THE FUNDAMENTAL PERIOD OF VIBRATION T_1 USING RAYLEIGH METHOD ..	48
2.6.3 BASE SHEAR FORCE AND DISTRIBUTION OF THE HORIZONTAL FORCES ALONG THE ELEVATION.....	49
2.6.4 DISTRIBUTION OF THE HORIZONTAL FORCES TO INDIVIDUAL FRAMES AND WALLS AND SHEAR FORCES	49
CHAPTER 3	
Specific rules for design and detailing of concrete building. Design for DCM and DCH.	
Illustration of elements design	53
3.1 Introduction and overview	55
3.2 Material properties	55
3.3 Geometry of foundation elements.....	56
3.4 ULS and SLS verifications and detailing according to Eurocodes 8 and 2	57
3.4.1 GENERAL	57
3.4.2 OVERVIEW OF THE DETAILED DESIGN PROCEDURE.....	57
3.4.3 ADDITIONAL INFORMATION FOR THE DESIGN OF BEAMS IN BENDING	60
3.4.4 ADDITIONAL INFORMATION FOR THE DESIGN OF COLUMNS.....	61
3.4.5 ADDITIONAL INFORMATION FOR THE DESIGN OF BEAMS IN SHEAR	61
3.4.6 ADDITIONAL INFORMATION FOR THE DESIGN OF DUCTILE WALLS	62
3.4.7 ADDITIONAL INFORMATION FOR THE DESIGN OF FOUNDATION BEAMS.....	62
3.4.8 ADDITIONAL INFORMATION FOR THE DESIGN OF FOOTINGS.....	62
3.5 Outcome of the detailed design.....	68
3.5.1 DESIGN MOMENT AND SHEAR ENVELOPES OF THE WALLS.....	68
3.5.2 REINFORCEMENT DRAWINGS.....	69
CHAPTER 4	
Introduction to the RC building example. Modeling and analysis of the design example	83
4.1 Introduction.....	85
4.2 Selection of geotechnical parameters	85
4.2.1 DEFINITION OF DESIGN VALUES.....	85
4.2.2 SOIL PROPERTIES	86
4.3 Design approaches	88

4.4	Requirement for construction sites	90
4.5	Liquefaction assessment	91
4.6	Slope stability analyses	93
4.7	Earth retaining structures.....	94
4.8	Foundation systems.....	98
	4.8.1 DIRECT FOUNDATIONS: FOOTING, RAFT	98
	4.8.2 PILES AND PIERS	102
4.9	Soil Structure Interaction	104
CHAPTER 5		
Specific rules for the design and detailing of steel buildings:		
(i)	Steel moment resisting frames	105
5.1	Definition of the structure	107
5.2	Checks of resistance and stiffness of beams	109
5.3	‘Weak Beam-Strong Column’ checks	110
5.4	Interior column. Axial compression check	111
5.5	Interior column. Plastic resistance at ground level.....	112
5.6	Evaluation of the seismic mass	112
5.7	Evaluation of seismic design shear using the ‘lateral forces’ method	113
5.8	Gravity load combined with earthquake effects	114
5.9	Dynamic analysis by spectral response and modal superposition method	114
5.10	Results of the analysis.....	115
5.11	Design of beam to column connection at an interior joint in line X2.....	120
5.12	Comment on design options	123
5.13	Design of reduced beam sections	125
5.14	Economy due to RBS	128
Specific rules for the design and detailing of steel buildings:		
(ii)	Composite steel concrete moment resisting frames	129
5.15	Structure Description	131
5.16	Characteristic Values of Actions on the Building	132
	5.16.1 PERMANENT ACTIONS	132
	5.16.2 VARIABLE ACTIONS	132
	5.16.3 SEISMIC ACTION	132
	5.16.4 COMBINATIONS OF ACTIONS FOR SERVICEABILITY LIMIT STATE DESIGN	136
	5.16.5 COMBINATIONS OF ACTIONS FOR ULTIMATE LIMIT STATE DESIGN .	137

5.16.6	ACTIONS ON MR FRAMES.....	137
5.17	Stages of Preliminary Design.....	138
5.17.1	ASSUMPTIONS	139
5.17.2	DESIGN	140
5.17.3	SECOND-ORDER EFFECTS.....	148
5.17.4	DAMAGE LIMITATION.....	150
5.17.5	SECTION AND STABILITY CHECKS OF COMPOSITE BEAMS	150
5.17.6	SECTION AND STABILITY CHECKS OF STEEL COLUMNS.....	165
5.17.7	SECTION AND STABILITY CHECKS OF COMPOSITE COLUMNS.....	175
5.17.8	GLOBAL AND LOCAL DUCTILITY CONDITION.....	185
Specific rules for the design and detailing of steel buildings:		
(iii)	Composite steel concrete frame with eccentric and concentric bracings.....	189
5.18	Definition of the structure.....	191
5.18.1	DIMENSIONS, MATERIAL PROPERTIES AND EARTHQUAKE ACTION ..	191
5.18.2	STEPS OF THE DESIGN DETAILED IN THIS REPORT	194
5.18.3	FINITE ELEMENT MODEL IN 3 DIMENSIONS.....	194
5.18.4	TYPE OF FRAME	195
5.18.5	FINAL CHARACTERISTICS OF THE BUILDING	195
5.19	Design of the slabs under gravity loads.....	196
5.19.1	BENDING RESISTANCE OF SLABS	196
5.19.2	SHEAR RESISTANCE OF SLABS	197
5.19.3	DEFLECTION OF THE SLAB.....	197
5.19.4	EUROCODE 2 CHECKS.....	197
5.20	Design of the columns under gravity loads.....	199
5.20.1	STEEL PROFILES	199
5.20.2	ACTION EFFECTS UNDER GRAVITY LOADS COMBINATIONS	200
5.20.3	BENDING AND SHEAR INTERACTION CHECK [EN 1993-1-1: 2005 CL. 6.2.8]	200
5.20.4	BENDING AND AXIAL FORCE INTERACTION CHECK [EN 1993-1-1: 2005 CL. 6.2.9].....	201
5.20.5	BUCKLING CHECK [EN 1993-1-1: 2005 CL. 6.3]	201
5.20.6	LATERAL TORSIONAL BUCKLING CHECK	203
5.20.7	INTERACTION CHECKS	204
5.21	Beams under gravity loads.....	206
5.21.1	ACTION EFFECTS UNDER GRAVITY LOADS COMBINATIONS	206

5.21.2	BENDING RESISTANCE	207
5.21.3	SHEAR RESISTANCE	209
5.21.4	OTHER CHECKS	209
5.22	Effects of torsion	209
5.23	P-Delta effects [EN 1998-1: 2004 cl. 4.4.2.2 (2) and (3)]	209
5.24	Eccentric bracings.....	211
5.24.1	DESIGN OF VERTICAL SEISMIC LINKS.....	211
5.24.2	DESIGN OF DIAGONALS	214
5.25	Check of eccentric bracings under gravity load combination	220
5.25.1	VERTICAL SEISMIC LINKS	220
5.25.2	CHECK OF RESISTANCES OF DIAGONALS	221
5.26	Check of the beam in the direction X under gravity combination of loads.....	222
5.27	Concentric bracings.....	222
5.27.1	PROPERTIES OF DIAGONAL ELEMENTS	222
5.27.2	EUROCODE 8 CHECKS	223
5.28	Check of columns under seismic actions.....	224
5.29	Check of beams under seismic actions	228
5.29.1	RESISTANCE REQUIREMENT	228
5.29.2	BEAM CHECKS	228
5.30	Diaphragm.....	230
5.31	Secondary elements.....	231
5.32	Summary of data and elements dimensions	231
CHAPTER 6		
	Base Isolation. Overview of key concepts	235
6.1	Introduction.....	237
6.2	The main principles of base isolation	237
6.2.1	OBJECTIVES OF BASE ISOLATION AND SCOPE	237
6.2.2	THE CONCEPT OF BASE ISOLATION	238
6.3	The isolating devices and their design.....	244
6.3.1	TYPES OF ISOLATION SYSTEMS CONSIDERED	244
6.3.2	RELIABILITY	245
6.3.3	EN 15129	245
6.3.4	SOME ASPECTS OF THE DESIGN OF DEVICES	246
6.4	General arrangement and design criteria.....	247

6.4.1 GENERAL ARRANGEMENT	247
6.4.2 DESIGN CRITERIA	248
6.5 Analysis	249
6.5.1 MODELLING	249
6.5.2 SEISMIC ACTION	249
6.5.3 EQUIVALENT LINEAR ANALYSIS	249
6.5.4 TYPES OF ANALYSIS	250
6.6 Example	252
CHAPTER 7	
Eurocode 8 Part 3. Assessment and retrofitting of buildings.....	257
7.1 Introduction.....	259
7.2 Performance requirements and compliance criteria	259
7.2.1 PERFORMANCE REQUIREMENTS	259
7.2.2 COMPLIANCE CRITERIA	261
7.3 Information for structural assessment.....	261
7.3.1 KNOWLEDGE LEVELS.....	261
7.3.2 CONFIDENCE FACTORS.....	262
7.4 Method of analysis	264
7.5 Verifications (Reinforced Concrete structures)	266
7.5.1 DEMAND QUANTITIES	266
7.5.2 MEMBERS/MECHANISMS CAPACITIES	267
7.5.3 VERIFICATION UNDER BI-DIRECTIONAL LOADING.....	267
7.6 Discussion	268
7.6.1 INTRODUCTION.....	268
7.6.2 THE ANALYST'S DEGREES OF FREEDOM.....	269
7.6.3 VARIABILITY IN THE RESULTS OF NOMINALLY "EQUIVALENT" ASSESSMENTS	269
7.6.4 PROPOSED ALTERNATIVE.....	272
7.7 Conclusions.....	275
ANNEXES	277

List of authors and editors

Authors:

Chapter 1- Overview of Eurocode 8. Performance requirements, ground conditions and seismic action

Eduardo C. Carvalho, *GAPRES SA, Chairman of CEN/TC250-SC8*

Chapter 2- Introduction to the RC building example. Modeling and analysis of the design example

Peter Fajfar, *University of Ljubljana*

Maja Kreslin, *University of Ljubljana*

Chapter 3- Specific rules for design and detailing of concrete building. Design for DCM and DCH. Illustration of elements design

Michael N. Fardis, *University of Patras*

Georgios Tsionis, *University of Patras*

Chapter 4- Introduction to the RC building example. Modeling and analysis of the design example

Alain Pecker, *Geodynamique and Structure*

Chapter 5- Specific rules for the design and detailing of steel buildings:

(i) Steel moment resisting frames

André Plumier, *University of Liege*

(ii) Composite steel concrete moment resisting frames

Hughes Somja, *INSA Rennes*

Hervé Degee, *University of Liege*

André Plumier, *University of Liege*

(iii) Composite steel concrete frame with eccentric and concentric bracings

Hervé Degee, *University of Liege*

André Plumier, *University of Liege*

Chapter 6- Base Isolation. Overview of key concepts

Philippe Bisch, *IOSIS, EGIS group*

Chapter 7- Eurocode 8 Part 3. Assessment and retrofitting of buildings

Paolo Emilio Pinto, *University of Rome, La Sapienza*

Paolo Franchin, *University of Rome, La Sapienza*

Editors:

Bora ACUN, Adamantia ATHANASOPOULOU, Artur V. PINTO

European Laboratory for Structural Assessment (ELSA)

Institute for the Protection and Security of the Citizen (IPSC)

Joint Research Center (JRC), European Commission

Eduardo C. Carvalho

Gapres SA, Chairman of CEN/TC250 SC8

Michael N. Fardis

University of Patras, Former Chairman of CEN/TC 250 SC8

Foreword

The **construction sector** is of strategic importance to the EU as it delivers the buildings and infrastructure needed by the rest of the economy and society. It represents more than **10% of EU GDP and more than 50% of fixed capital formation**. It is the largest single economic activity and it is the biggest industrial employer in Europe. The sector employs directly almost 20 million people. In addition, construction is a key element for the implementation of the **Single Market** and other construction relevant EU Policies, e.g.: **Environment and Energy**.

In line with the EU's strategy for smart, sustainable and inclusive growth (EU2020), **Standardization** will play an important part in supporting the strategy. The **EN Eurocodes** are a set of **European standards** which provide common rules for the design of construction works, to check their strength and stability against live and extreme loads such as earthquakes and fire.

With the publication of all the 58 Eurocodes Parts in 2007, the implementation of the Eurocodes is extending to all European countries and there are firm steps toward their adoption internationally. The Commission Recommendation of 11 December 2003 stresses the importance of **training in the use of the Eurocodes**, especially in engineering schools and as part of continuous professional development courses for engineers and technicians, should be promoted both at national and international level.

In light of the Recommendation, DG JRC is collaborating with DG ENTR and CEN/TC250 "Structural Eurocodes" and is publishing the Report Series '**Support to the implementation, harmonization and further development of the Eurocodes**' as JRC Scientific and Technical Reports. This Report Series include, at present, the following types of reports:

1. Policy support documents – Resulting from the work of the JRC and cooperation with partners and stakeholders on 'Support to the implementation, promotion and further development of the Eurocodes and other standards for the building sector';
2. Technical documents – Facilitating the implementation and use of the Eurocodes and containing information and practical examples (Worked Examples) on the use of the Eurocodes and covering the design of structures or its parts (e.g. the technical reports containing the practical examples presented in the workshop on the Eurocodes with worked examples organized by the JRC);
3. Pre-normative documents – Resulting from the works of the CEN/TC250 Working Groups and containing background information and/or first draft of proposed normative parts. These documents can be then converted to CEN technical specifications;
4. Background documents – Providing approved background information on current Eurocode part. The publication of the document is at the request of the relevant CEN/TC250 Sub-Committee;
5. Scientific/Technical information documents – Containing additional, non-contradictory information on current Eurocode part, which may facilitate its implementation and use, preliminary results from pre-normative work and other studies, which may be used in future revisions and further developments of the standards.. The authors are various stakeholders involved in Eurocodes process and the publication of these documents is authorized by relevant CEN/TC250 Sub-Committee, Horizontal Group or Working Group.

Editorial work for this Report Series is **assured by the JRC** together with partners and stakeholders, when appropriate. The publication of the reports type 3, 4 and 5 is made after approval for publication from the CEN/TC250 Co-ordination Group.

The publication of these reports by the JRC serves the purpose of implementation, further harmonization and development of the Eurocodes. However, it is noted that neither the Commission nor CEN are obliged to follow or endorse any recommendation or result included in these reports in the European legislation or standardization processes.

This report is part of the so-called Technical documents (Type 2 above) and contains a comprehensive description of the practical examples presented at the workshop "Eurocode 8: Seismic Design of Buildings" with emphasis on worked examples. The workshop was held on

10-11 February 2011 in Lisbon, Portugal and was co-organized with CEN/TC250/Sub-Committee 8, the National Laboratory for Civil Engineering (Laboratorio Nacional de Engenharia Civil - LNEC, Lisbon), with the support of CEN and the Member States. The workshop addressed representatives of public authorities, national standardisation bodies, research institutions, academia, industry and technical associations involved in training on the Eurocodes. The main objective was to facilitate training on Eurocode 8 related to building design through the transfer of knowledge and training information from the Eurocode 8 writers (CEN/TC250 Sub-Committee 8) to key trainers at national level and Eurocode users.

The workshop was a unique occasion to compile a state-of-the-art training kit comprising the slide presentations and technical papers with the worked example for a structure designed following the Eurocode 8. The present JRC Report compiles all the technical papers prepared by the workshop lecturers resulting in the presentation of a reinforced concrete building designed using Eurocodes 8.

The editors and authors have sought to present useful and consistent information in this report. However, it must be noted that **the report is not a complete design example** and that **the reader may identify some discrepancies** between chapters. The chapters presented in the report have been prepared by different authors and are reflecting the different practices in the EU Member States both “.” (full stop) and “,” (comma) are used as decimal separator. **Users of information contained in this report must satisfy themselves of its suitability for the purpose for which they intend to use it.**

We would like to gratefully acknowledge the workshop lecturers and the members of CEN/TC250 Sub-Committee 8 for their contribution in the organization of the workshop and development of the training material comprising the slide presentations and technical papers with the worked examples. We would also like to thank the Laboratorio Nacional de Engenharia Civil, especially Ema Coelho, Manuel Pipa and Pedro Pontifice for their help and support in the local organization of the workshop.

All the material prepared for the workshop (slides presentations and JRC Report) is available to download from the “Eurocodes: Building the future” website (<http://eurocodes.jrc.ec.europa.eu>).

Ispra, November 2011

Bora Acun, Adamantia Athanasopoulou, Artur Pinto

European Laboratory for Structural Assessment (ELSA)

Institute for the Protection and Security of the Citizen (IPSC)

Joint Research Centre (JRC), European Commission

Eduardo C. Carvalho

Gapres SA, Chairman of CEN/TC250 SC8

Michael N. Fardis

University of Patras, Former Chairman of CEN/TC 250 SC8

CHAPTER 1

Overview of Eurocode 8. Performance requirements, ground conditions and seismic action

E.C. Carvalho

GAPRES SA

Chairman of CEN/TC250-SC8

1.1 Overview of the Eurocodes

Culminating a process of technical harmonization with roots in the seventies, CEN - European Committee for Standardization, mandated by the European Union, published a set of standards, known as the Eurocodes, with common rules for structural design within the European Union.

The background and the status of the Eurocodes is briefly described in the common Foreword to all Eurocodes that is reproduced below:

Background of the Eurocode programme

In 1975, the Commission of the European Community decided on an action programme in the field of construction, based on article 95 of the Treaty. The objective of the programme was the elimination of technical obstacles to trade and the harmonisation of technical specifications.

Within this action programme, the Commission took the initiative to establish a set of harmonised technical rules for the design of construction works which, in a first stage, would serve as an alternative to the national rules in force in the Member States and, ultimately, would replace them.

For fifteen years, the Commission, with the help of a Steering Committee with Representatives of Member States, conducted the development of the Eurocodes programme, which led to the first generation of European codes in the 1980's.

In 1989, the Commission and the Member States of the EU and EFTA decided, on the basis of an agreement between the Commission and CEN, to transfer the preparation and the publication of the Eurocodes to CEN through a series of Mandates, in order to provide them with a future status of European Standard (EN). This links de facto the Eurocodes with the provisions of all the Council's Directives and/or Commission's Decisions dealing with European standards (e.g. the Council Directive 89/106/EEC on construction products - CPD - and Council Directives 93/37/EEC, 92/50/EEC and 89/440/EEC on public works and services and equivalent EFTA Directives initiated in pursuit of setting up the internal market).

The Structural Eurocode programme comprises the following standards generally consisting of a number of Parts:

EN 1990	Eurocode:	Basis of structural design
EN 1991	Eurocode 1:	Actions on structures
EN 1992	Eurocode 2:	Design of concrete structures
EN 1993	Eurocode 3:	Design of steel structures
EN 1994	Eurocode 4:	Design of composite steel and concrete structures
EN 1995	Eurocode 5:	Design of timber structures
EN 1996	Eurocode 6:	Design of masonry structures
EN 1997	Eurocode 7:	Geotechnical design
EN 1998	Eurocode 8:	Design of structures for earthquake resistance
EN 1999	Eurocode 9:	Design of aluminium structures

Eurocode standards recognise the responsibility of regulatory authorities in each Member State

and have safeguarded their right to determine values related to regulatory safety matters at national level where these continue to vary from State to State.

Status and field of application of Eurocodes

The Member States of the EU and EFTA recognise that Eurocodes serve as reference documents for the following purposes:

- as a means to prove compliance of building and civil engineering works with the essential requirements of Council Directive 89/106/EEC, particularly Essential Requirement N°1 - Mechanical resistance and stability - and Essential Requirement N°2 - Safety in case of fire;*
- as a basis for specifying contracts for construction works and related engineering services;*
- as a framework for drawing up harmonised technical specifications for construction products (ENs and ETAs)*

The Eurocodes, as far as they concern the construction works themselves, have a direct relationship with the Interpretative Documents referred to in Article 12 of the CPD, although they are of a different nature from harmonised product standards. Therefore, technical aspects arising from the Eurocodes work need to be adequately considered by CEN Technical Committees and/or EOTA Working Groups working on product standards with a view to achieving a full compatibility of these technical specifications with the Eurocodes.

The Eurocode standards provide common structural design rules for everyday use for the design of whole structures and component products of both a traditional and an innovative nature. Unusual forms of construction or design conditions are not specifically covered and additional expert consideration will be required by the designer in such cases.

Although the Eurocodes are the same across the different countries, for matters related to safety and economy or for aspects of geographic or climatic nature national adaptation is allowed if therein explicitly foreseen. These are the so-called Nationally Determined Parameters (NDPs) that are listed at the beginning of each Eurocode. For these parameters, each country, in a National Annex included in the corresponding National Standard, may take a position, either keeping or modifying them.

The possible contents and extent of the Nationally Determined Parameters is also described in the common Foreword to all Eurocodes as reproduced below:

National Standards implementing Eurocodes

The National Standards implementing Eurocodes will comprise the full text of the Eurocode (including any annexes), as published by CEN, which may be preceded by a National title page and National foreword, and may be followed by a National annex.

The National annex may only contain information on those parameters which are left open in the Eurocode for national choice, known as Nationally Determined Parameters, to be used for the design of buildings and civil engineering works to be constructed in the country concerned, i.e. :

- values and/or classes where alternatives are given in the Eurocode,*
- values to be used where a symbol only is given in the Eurocode,*
- country specific data (geographical, climatic, etc.), e.g. snow map,*
- the procedure to be used where alternative procedures are given in the Eurocode.*

It may also contain

- decisions on the application of informative annexes,*
- references to non-contradictory complementary information to assist the user to apply the Eurocode.*

The concept of Nationally Determined Parameters thus allows small national variations without modifying the overall structure of each Eurocode. This has been an essential tool to allow the National Authorities to control the safety and economic consequences of structural design in their respective countries without prejudice of the fundamental aim of the Eurocodes to remove technical barriers in the pursuit of setting up the internal market in the Construction Sector and in particular for the exchange of services in the field of Structural Design.

For each Nationally Determined Parameter, the Eurocodes present a recommended value or procedure and it is interesting to note that, insofar as it is known at the moment, in the national implementation process that is currently underway, countries have been adopting, in most cases, the recommended values. It is therefore expected that the allowed national variations in the Eurocodes shall progressively vanish.

Out of the 10 Eurocodes, Eurocode 8 deals with seismic design. Its rules are complementary (and in a few cases alternative) to the design rules included in the other Eurocodes that deal exclusively with non seismic design situations.

Hence, in seismic regions, structural design should conform to the provisions of Eurocode 8 together with the provisions of the other relevant Eurocodes (EN 1990 to EN 1997 and EN 1999).

1.2 Eurocode 8

Eurocode 8, denoted in general by EN 1998: "Design of structures for earthquake resistance", applies to the design and construction of buildings and civil engineering works in seismic regions.

It covers common structures and, although its provisions are of general validity, special structures, such as nuclear power plants, large dams or offshore structures are beyond its scope. Its seismic design should satisfy additional requirements and be subject to complementary verifications.

The objectives of seismic design in accordance with Eurocode 8 are explicitly stated. Its purpose is to ensure that in the event of earthquakes:

- o *human lives are protected;*
- o *damage is limited; and*
- o *structures important for civil protection remain operational.*

These objectives are present throughout the code and condition the principles and application rules therein included.

Eurocode 8 is composed by 6 parts dealing with different types of constructions or subjects:

- o EN1998-1: General rules, seismic actions and rules for buildings
- o EN1998-2: Bridges
- o EN1998-3: Assessment and retrofitting of buildings
- o EN1998-4: Silos, tanks and pipelines
- o EN1998-5: Foundations, retaining structures and geotechnical aspects
- o EN1998-6: Towers, masts and chimneys

Out of these parts, Part 1, Part 3 and Part 5 are those relevant to the design of buildings and therefore are those dealt with in the Workshop.

In particular Part 1 is the leading part since it presents the basic concepts, the definition of the seismic action and the rules for buildings of different structural materials. Its basic concepts and objectives are described in the following.

1.2.1 SCOPE OF EN 1998-1

EN 1998-1 (it is noticed that, herein, all references are made to EN 1998-1 published by CEN in 2005) applies to the design of buildings and civil engineering works in seismic regions and is subdivided into 10 sections:

- o Section 2 contains the basic performance requirements and compliance criteria applicable to buildings and civil engineering works in seismic regions.
- o Section 3 gives the rules for the representation of seismic actions and for their combination with other actions.
- o Section 4 contains general design rules relevant specifically to buildings.
- o Sections 5 to 9 contain specific rules for various structural materials and elements, relevant specifically to buildings (concrete, steel, composite steel-concrete, timber and masonry buildings).
- o Section 10 contains the fundamental requirements and other relevant aspects of design and safety related to base isolation of structures and specifically to base isolation of buildings.

1.2.2 PERFORMANCE REQUIREMENTS AND COMPLIANCE CRITERIA

1.2.2.1 Fundamental requirements

EN 1998-1 asks for a **two level seismic design** establishing explicitly the two following requirements:

- o No-collapse requirement:

The structure shall be designed and constructed to withstand the design seismic action without local or global collapse, thus retaining its structural integrity and a residual load bearing capacity after the seismic event.

- o Damage limitation requirement:

The structure shall be designed and constructed to withstand a seismic action having a larger probability of occurrence than the design seismic action, without the occurrence of damage and the associated limitations of use, the costs of which would be disproportionately high in comparison with the costs of the structure itself.

The first requirement is related to the protection of life under a rare event, through the prevention of the global or local collapse of the structure that, after the event, should retain its integrity and a sufficient residual load bearing capacity. After the event the structure may present substantial damages, including permanent drifts, to the point that it may be economically unrecoverable, but it should be able to protect human life in the evacuation process or during aftershocks.

In the framework of the Eurocodes, that uses the concept of Limit States, this performance requirement is associated with the Ultimate Limit State (ULS) since it deals with the safety of people or the whole structure.

The second requirement is related to the reduction of economic losses in frequent earthquakes, both in what concerns structural and non-structural damages. Under such kind of events, the structure should not have permanent deformations and its elements should retain its original strength and

stiffness and hence should not need structural repair. In view of the minimization of non structural damage the structure should have adequate stiffness to limit, under such frequent events, its deformation to levels that do not cause important damage on such elements. Some damage to non-structural elements is acceptable but they should not impose significant limitations of use and should be repairable economically.

Considering again the framework of the Eurocodes, this performance requirement is associated with the Serviceability Limit State (SLS) since it deals with the use of the building, comfort of the occupants and economic losses.

As indicated above, the two performance levels are to be checked against **two different levels of the seismic action**, interrelated by the seismicity of the region.

The definition of these levels of the seismic action for design purposes falls within the scope of the Nationally Determined Parameters. In fact the random nature of the seismic events and the limited resources available to counter their effects are such as to make the attainment of the design objectives only partially possible and only measurable in probabilistic terms.

Also, the extent of the protection that can be provided is a matter of optimal allocation of resources and is therefore expected to vary from country to country, depending on the relative importance of the seismic risk with respect to risks of other origin and on the global economic resources.

In spite of this EN 1998-1 addresses the issue, starting with the case of ordinary structures, for which it recommends the following two levels:

- o Design seismic action (for local collapse prevention) with 10% probability of exceedance in 50 years which corresponds to a mean return period of 475 years.
- o Damage limitation seismic action with 10% probability of exceedance in 10 years which corresponds to a mean return period of 95 years.

The damage limitation seismic action is sometimes also referred to as the Serviceability seismic action.

It is worth recalling the concept of mean return period which is the inverse of the mean (annual) rate of occurrence (ν) of a seismic event exceeding a certain threshold.

Assuming a Poisson model for the occurrence of earthquakes, the mean return period T_R is given by:

$$T_R = 1/\nu = -T_L / \ln(1 - P) \quad (1.1)$$

where T_L is the reference time period and P is the probability of exceedance of such threshold (with the recommended values indicated above, for the design seismic action we have $T_L = 50$ years and $P = 10\%$, resulting in $T_R = 475$ years).

1.2.2.2 Reliability differentiation

The levels of the seismic action described above are meant to be applied to ordinary structures and are considered the **reference seismic action** (which is anchored to the reference peak ground acceleration a_{gR}). However, EN 1998-1 foresees the possibility to differentiate the target reliabilities (of fulfilling the no-collapse and damage limitation requirements) for different types of buildings or other constructions, depending on its importance and consequences of failure.

This is achieved by modifying the hazard level considered for design (i.e. modifying the mean return period for the selection of the seismic action for design).

In practical terms EN 1998-1 prescribes that:

Reliability differentiation is implemented by classifying structures into different importance classes. An importance factor γ_I is assigned to each importance class. Wherever feasible this

factor should be derived so as to correspond to a higher or lower value of the return period of the seismic event (with regard to the reference return period) as appropriate for the design of the specific category of structures.

The different levels of reliability are obtained by multiplying the reference seismic action by this importance factor γ_I which, in case of using linear analysis, may be applied directly to the action effects obtained with the reference seismic action.

Although EN 1998-1 (and also the other Parts of EN 1998) presents recommended values for the importance factors, this is a Nationally Determined Parameter, since it depends not only on the global policy for seismic safety of each country but also on the specific characteristics of its seismic hazard.

In a Note EN 1998-1 provides some guidance on the latter aspect. Specifically, the Note reads as follows:

NOTE: At most sites the annual rate of exceedance, $H(a_{gR})$, of the reference peak ground acceleration a_{gR} may be taken to vary with a_{gR} as: $H(a_{gR}) \sim k_0 a_{gR}^{-k}$, with the value of the exponent k depending on seismicity, but being generally of the order of 3. Then, if the seismic action is defined in terms of the reference peak ground acceleration a_{gR} , the value of the importance factor γ_I multiplying the reference seismic action to achieve the same probability of exceedance in T_L years as in the T_{LR} years for which the reference seismic action is defined, may be computed as $\gamma_I \sim (T_{LR}/T_L)^{-1/k}$. Alternatively, the value of the importance factor γ_I that needs to multiply the reference seismic action to achieve a value of the probability of exceeding the seismic action, P_L , in T_L years other than the reference probability of exceedance P_{LR} , over the same T_L years, may be estimated as $\gamma_I \sim (P_L/P_{LR})^{-1/k}$.

This relation is depicted in Fig. 1.2.1 for three different values of the seismicity exponent k , including the “usual” value indicated in the Note ($k = 3$).

This value ($k = 3$) is typical of regions of high seismicity in Europe (namely in Italy). Smaller values of k correspond to low seismicity regions or regions where the hazard is controlled by large magnitude events at long distance, occurring widely spaced in time. On the other hand larger values of k correspond to regions where the event occurrence rate is high.

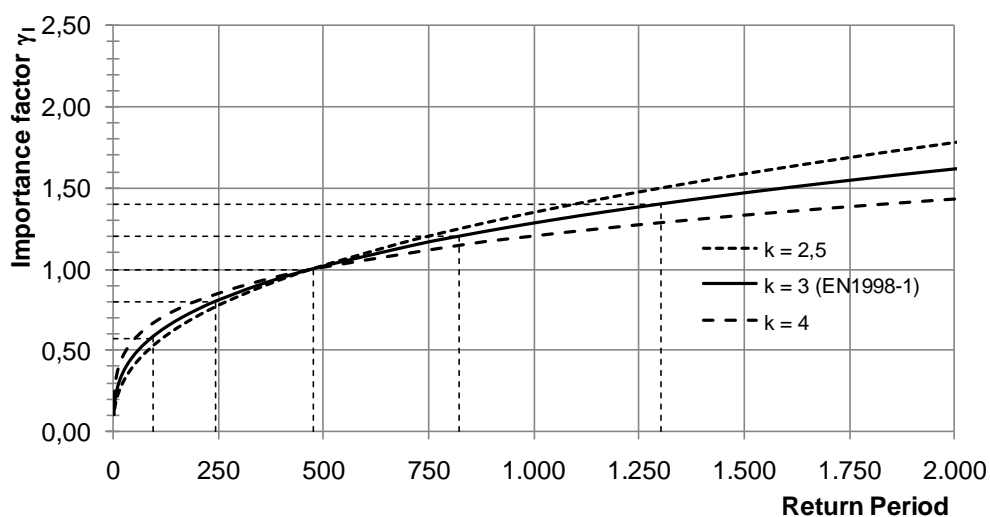

Fig. 1.2.1 Relationship between the Importance Factor and the Return Period (for different seismicity exponent)

It should be noticed that this relation is just a rough approximation of reality. In fact, even for a single site, if we consider the hazard described by spectral ordinates (and not only by the peak ground

acceleration), there is not a constant value of k . It depends on the on the period range and also on the value of the spectral acceleration itself (typically with larger values of k for larger spectral accelerations). Values of k are also larger at short to intermediate periods than at long periods.

However, the plots in Fig. 1.2.1 somehow illustrate the dependence of the importance factor on the mean return period chosen for design.

Buildings in EN 1998-1 are classified in 4 importance classes depending on:

- o the consequences of collapse for human life;
- o their importance for public safety and civil protection in the immediate post-earthquake period and
- o the social and economic consequences of collapse.

The definition of the buildings belonging to the different importance Classes is given in Table 1.2.1 reproduced from EN 1998-1.

Table 1.2.1 Importance classes and recommended values for importance factors for buildings

Importance class	Buildings	Importance factor γ_I (recommended value)
I	Buildings of minor importance for public safety, e.g. agricultural buildings, etc.	0,8
II	Ordinary buildings, not belonging in the other categories.	1,0
III	Buildings whose seismic resistance is of importance in view of the consequences associated with a collapse, e.g. schools, assembly halls, cultural institutions etc.	1,2
IV	Buildings whose integrity during earthquakes is of vital importance for civil protection, e.g. hospitals, fire stations, power plants, etc.	1,4

Importance class II is the reference case and is assigned to (ordinary) buildings for which the reference seismic action is derived as indicated above. Accordingly the importance factor for this class of buildings is $\gamma_I = 1,0$.

Importance class III corresponds to buildings with large human occupancy or buildings housing unique and important contents as, for instance, museums or archives.

Importance class IV corresponds to buildings essential for civil protection after the earthquake, including buildings vital for rescue operations and buildings vital for the treatment of the injured.

Importance class I corresponds to buildings of low economic importance and with little and rare human occupancy.

Besides these aspects influencing the importance class of each building, the importance factor may also have to take in consideration the specific case of buildings housing dangerous installations or materials. For those cases EN 1998-4 provides further guidance.

The recommended values in EN 1998-1 for the importance factors associated with the various importance classes are also presented in Table 1.2.1.

Accordingly, for the different importance classes, the design ground acceleration (on type A ground, as presented below), a_g is equal to a_{gR} times the importance factor γ_I :

$$a_g = \gamma_I \cdot a_{gR} \tag{1.2}$$

In the absence of an explicit indication in EN 1998-1 of the return periods associated to the different importance classes the relationship presented in Fig. 1.2.1 may be used to implicitly obtain a rough indication of these return periods.

Considering the curve for the exponent $k = 3$ and introducing the recommended values for γ we obtain the (implicit) mean return periods in EN 1998-1. These values are indicated in Table 1.2.2, where the values for other values of k are also presented.

Table 1.2.2 Importance classes and recommended values for importance factors for buildings

Importance class	Importance factor γ	Implicit mean return period (years)		
		$k = 2,5$	$k = 3$	$k = 4$
I	0,8	272	243	195
II	1,0	475	475	475
III	1,2	749	821	985
IV	1,4	1.102	1.303	1.825

These values should be taken with caution but they show that for Class I structures the implicit return period is of the order of 200 to 250 years, whereas for Class III structures it is of the order of 800 to 1.000 years. For Class IV structures the implicit return periods varies more widely for the various values of the exponent k , ranging from 1.100 to 1.800 years.

In any case, the definition of the importance factors is a Nationally Determined Parameter and countries may introduce other considerations (besides the strict consideration of the return period) and adopt whatever values they consider suitable for their territory.

1.2.2.3 Compliance criteria

EN 1998-1 prescribes that in order to satisfy the fundamental requirements two limit states should be checked:

- o Ultimate Limit States (ULS);
- o Damage Limitation States (associated with Serviceability Limit States – SLS).

Additionally EN 1998-1 requires the satisfaction of a number of pertinent specific measures in order to limit the uncertainties and to promote a good behaviour of structures under seismic actions more severe than the design seismic action.

These measures shall be presented and commented below but essentially its prescription is implicitly equivalent to the specification of a third performance requirement that intends to prevent global collapse during a very strong and rare earthquake (i.e with return period in the order of 1.500 to 2.000 years, much longer than the design earthquake).

After such earthquake the structure may be heavily damaged, with large permanent drifts and having lost significantly its lateral stiffness and resistance but it should still keep a minimal load bearing capacity to prevent global collapse.

1.2.2.4 Ultimate limit state

The no-collapse performance level is considered as the Ultimate Limit State in the framework of the Eurocode “design system”, namely in accordance with EN 1990 – Basis of Design.

Satisfaction of this limit state asks for the verification that the structural system has simultaneously lateral resistance and energy-dissipation capacity.

This recognises that the fulfilment of the no-collapse requirement does not require that the structure remains elastic under the design seismic action. On the contrary it allows/accepts the development of significant inelastic deformations in the structural members, provided that integrity of the structure is kept.

It also relies on the (stable) energy dissipation capacity of the structure to control the build up of energy in the structure resulting from the seismic energy input that, otherwise, would result in much larger response amplitudes of the structure.

The basic concept is the possible trade-off between resistance and ductility that is at the base of the introduction of Ductility Classes and the use of behaviour factors that is a main feature of EN 1998-1.

This is explained in the code as follows:

The resistance and energy-dissipation capacity to be assigned to the structure are related to the extent to which its non-linear response is to be exploited. In operational terms such balance between resistance and energy-dissipation capacity is characterised by the values of the behaviour factor q and the associated ductility classification, which are given in the relevant Parts of EN 1998. As a limiting case, for the design of structures classified as low-dissipative, no account is taken of any hysteretic energy dissipation and the behaviour factor may not be taken, in general, as being greater than the value of 1,5 considered to account for overstrengths. For steel or composite steel concrete buildings, this limiting value of the q factor may be taken as being between 1,5 and 2 (see Note 1 of Table 6.1 or Note 1 of Table 7.1, respectively). For dissipative structures the behaviour factor is taken as being greater than these limiting values accounting for the hysteretic energy dissipation that mainly occurs in specifically designed zones, called dissipative zones or critical regions.

In spite of such basic concepts, the operational verifications required in EN 1998-1 to check the satisfaction of this limit state by the structure are **force-based**, essentially in line with all the other Eurocodes.

It should be noted that, exactly to the contrary, the physical character of the seismic action corresponds to the application of (rapidly changing) displacements at the base of the structures and not to the application of forces.

In fully linear systems there would be equivalence in representing the action as imposed forces or imposed displacements. However, in nonlinear systems, the application of force controlled or displacement controlled actions may result in quite different response of the structure. Accordingly, the ability of structures to withstand earthquakes depends essentially on its ability to sustain lateral deformations in response to the earthquake, keeping its load bearing capacity (and not on the simple ability to support lateral forces).

Notwithstanding all this, the use of force-based design is well established and, as mentioned above, is adopted in EN 1998-1 as the reference method, because most of other actions with which structural designers have to cope are forces imposed to the structures.

Hence within the overall design process the use of a force based approach, even for seismic actions, is very practical and attractive. Furthermore, analytical methods for a displacement based approach in seismic design are not fully developed and not familiar to the ordinary designer.

It should however be noticed that EN 1998-1 opens the possibility to use displacement-based approaches as alternative design methods for which it presents an Informative Annex with operational rules to compute the target displacements for Nonlinear Static Analysis (Pushover).

Besides the verification of the individual structural elements (for resistance and ductility), in accordance with specific rules for the different structural materials, the Ultimate Limit State verification entails the checking of:

- o the overall stability of the structure (overturning and sliding)
- o the foundations and the bearing capacity of the soil
- o the influence of second order effects
- o the influence of non structural elements to avoid detrimental effects.

1.2.2.5 Damage limitation state

As indicated above the performance requirement associated with this Limit State requires the structure to support a relatively frequent earthquake without significant damage or loss of operability.

Damage is only expected in non structural elements and its occurrence depends on the deformation that the structure, in response to the earthquake, imposes on such elements. The same essentially applies to the loss of operability of systems and networks (although in some equipments acceleration may also be relevant to cause damage).

Accordingly an adequate degree of reliability against unacceptable damage is needed and checks have to be made on the deformation of the structure and its comparison with deformation limits that depend on the characteristics of the non structural elements.

For instance, for buildings EN 1998-1 establishes the following limits to the interstorey drift (relative displacement divided by the interstorey height) due to the frequent earthquake (Serviceability seismic action):

- o 0,5 % for buildings having non-structural elements of brittle materials attached to the structure:
- o 0,75 % for buildings having ductile non-structural elements:
- o 1,0 % for buildings having non-structural elements fixed in a way so as not to interfere with structural deformations or without non-structural elements

Additional requirements may be imposed in structures important for civil protection so that the function of the vital services in the facilities is maintained.

1.2.2.6 Specific measures

As indicated in 1.2.2.3 above, EN 1998-1 aims at providing implicitly the satisfaction of a third performance level that intends to prevent global collapse during a very strong and rare earthquake.

This is not achieved by specific checks for an higher level of the design seismic action but rather by imposing some so called specific measures to be taken in consideration along the design process.

These specific measures, which aim at reducing the uncertainty of the structural response, indicate that:

- o To the extent possible, structures should have simple and regular forms both in plan and elevation.
- o In order to ensure an overall dissipative and ductile behaviour, brittle failure or the premature formation of unstable mechanisms should be avoided. To this end resort is made to capacity

design procedures. This is used to obtain a hierarchy of resistance of the various structural components and of the failure modes necessary for ensuring a suitable plastic mechanism and for avoiding brittle failure modes.

- o Special care should be exercised in the design of the regions where nonlinear response is foreseeable since the seismic performance of a structure is largely dependent on the behaviour of these critical regions or elements. Hence the detailing of the structure in general and of these regions or elements in particular, should aim at ensuring that it maintains the capacity to transmit the necessary forces and to dissipate energy under cyclic conditions.
- o The analysis should be based on adequate structural models, which, when necessary, should take into account the influence of soil deformability and of non-structural elements.
- o The stiffness of the foundations shall be adequate for transmitting the actions received from the superstructure to the ground as uniformly as possible.
- o The design documents should be quite detailed and include all relevant information regarding materials characteristics, sizes of all members, details and special devices to be applied, if appropriate.
- o The necessary quality control provisions should also be given in the design documents and the checking methods to be used should be specified, namely for the elements of special structural importance.
- o In regions of high seismicity and in structures of special importance, formal quality system plans, covering design, construction, and use, additional to the control procedures prescribed in the other relevant Eurocodes, should be used.

1.2.3 GROUND CONDITIONS

Nowadays it is widely recognised that the earthquake vibration at the surface is strongly influenced by the underlying ground conditions and correspondingly the ground characteristics very much influence the seismic response of structures.

The importance of such influence is taken in consideration in EN 1998-1 that requires that appropriate investigations (in situ or in the laboratory) must be carried out in order to identify the ground conditions. Guidance for such investigation is given in EN 1998-5.

This ground investigation has two main objectives:

- o To allow the classification of the soil profile, in view of defining the ground motion appropriate to the site (i.e. allowing the selection of the relevant **spectral shape**, among various different possibilities, as shall be presented below).
- o To identify the possible occurrence of a **soil behaviour** during an earthquake, **detrimental** to the response of the structure.

In relation to the latter aspect, the construction site and the nature of the supporting ground should normally be free from risks of ground rupture, slope instability and permanent settlements caused by liquefaction or densification in the event of an earthquake.

If the ground investigation show that such risks do exist, measures should be taken to mitigate its negative effects on the structure or the location should be reconsidered.

In what concerns the first aspect, EN 1998-1 provides **five ground profiles**, denoted Ground types A, B, C, D, and E, described by the stratigraphic profiles and parameters given in Table 1.2.3.

Three parameters are used in the classification provided in Table 1.2.3 (reproduced from EN 1998-1) for a quantitative definition of the soil profile:

- o the value of the average shear wave velocity, $v_{s,30}$
- o the number of blows in the standard penetration test (N_{SPT})
- o the undrained cohesive resistance (c_u)

The **average shear wave velocity** $v_{s,30}$ is the leading parameter for the selection of the ground type. It should be used whenever possible and its value should be computed in accordance with the following expression:

$$v_{s,30} = \frac{30}{\sum_{i=1,N} \frac{h_i}{v_i}} \quad (1.3)$$

where h_i and v_i denote the thickness (in metres) and the shear-wave velocity (at a shear strain level of 10^{-5} or less) of the i -th formation or layer, in a total of N , existing in the top 30 m.

When direct information about shear wave velocities is not available, the other parameters of Table 1.2.3 may be used to select the appropriate ground type.

Table 1.2.3 Ground Types

Ground type	Description of stratigraphic profile	Parameters		
		$v_{s,30}$ (m/s)	N_{SPT} (blows/30cm)	c_u (kPa)
A	Rock or other rock-like geological formation, including at most 5 m of weaker material at the surface.	> 800	–	–
B	Deposits of very dense sand, gravel, or very stiff clay, at least several tens of metres in thickness, characterised by a gradual increase of mechanical properties with depth.	360 – 800	> 50	> 250
C	Deep deposits of dense or medium-dense sand, gravel or stiff clay with thickness from several tens to many hundreds of metres.	180 – 360	15 - 50	70 - 250
D	Deposits of loose-to-medium cohesionless soil (with or without some soft cohesive layers), or of predominantly soft-to-firm cohesive soil.	< 180	< 15	< 70
E	A soil profile consisting of a surface alluvium layer with v_s values of type C or D and thickness varying between about 5 m and 20 m, underlain by stiffer material with $v_s > 800$ m/s.			
S_1	Deposits consisting, or containing a layer at least 10 m thick, of soft clays/silts with a high plasticity index ($PI > 40$) and high water content	< 100 (indicative)	–	10 - 20
S_2	Deposits of liquefiable soils, of sensitive clays, or any other soil profile not included in types A – E or S_1			

Ground types **A to D** range from rock or other rock-like formations to loose cohesionless soils or soft cohesive soils.

Ground Type **E** is essentially characterised by a **sharp stiffness contrast** between a (soft or loose) surface layer (thickness varying between 5 to 20 m) and the underlying much stiffer formation.

Two additional soil profiles (S_1 and S_2) are also included in Table 1.2.3. For sites with ground conditions matching either one of these ground types, special studies for the definition of the seismic action are required.

For these types, and particularly for S_2 , the possibility of soil failure under the seismic action shall be taken into account. It is recalled that liquefaction leads normally to catastrophic failures of structures resting on these formations. In such event the soil loses its bearing capacity, entailing the collapse of any foundation system previously relying on such bearing capacity.

Special attention should be paid if the deposit is of ground type S_1 . Such soils typically have very low values of v_s , low internal damping and an abnormally extended range of linear behaviour and can therefore produce anomalous seismic site amplification and soil-structure interaction effects.

In this case a special study to define the seismic action should be carried out, in order to establish the dependence of the response spectrum on the thickness and v_s value of the soft clay/silt layer and on the stiffness contrast between this layer and the underlying materials.

1.2.4 SEISMIC ACTION

The seismic action to be considered for design purposes should be based on the estimation of the ground motion expected at each location in the future, i.e. it should be based on the **hazard assessment**.

Seismic hazard is normally represented by hazard curves that depict the exceedance probability of a certain seismologic parameter (for instance the peak ground acceleration, velocity or displacement) for a given period of exposure, at a certain location (normally assuming a rock ground condition).

It is widely recognised that peak values of the ground motion parameters (namely the peak ground acceleration) are not good descriptors of the severity of an earthquake and of its possible consequences on constructions.

Hence the more recent trend is to describe the seismic hazard by the values of the spectral ordinates (at certain key periods in the response spectrum). In spite of this, for the sake of simplicity, in EN1998-1 the seismic hazard is still described only by the value of the **reference peak ground acceleration** on ground type A, (a_{gR}).

For each country, the seismic hazard is described by a zonation map defined by the National Authorities. For this purpose the national territories should be subdivided into seismic zones, depending on the local hazard. By definition (in the context of EN1998-1) the hazard within each zone is assumed to be constant i.e. the reference peak ground acceleration is constant.

The reference peak ground acceleration (a_{gR}), for each seismic zone, corresponds to the reference return period T_{NCR} , chosen by the National Authorities for the seismic action for the no-collapse requirement (it is recalled that, as indicated above, the recommended value is $T_{NCR} = 475$ years).

Hazard maps, from which the zonation maps result, are derived from attenuation relationships that describe (with empirical expressions) the variation of the ground motion with the Magnitude (M) and Distance (R) from the source.

Just to illustrate such relationship, Fig 1.2.2 presents the attenuation for the peak ground acceleration proposed by Ambraseys (1996) for intraplate seismicity in Europe.

The attenuation of a_g is given by the expression:

$$\log a_g = -1,48 + 0,27 \cdot M - 0,92 \log R \quad (1.4)$$

where M is the Magnitude and R is the epicentral distance. The expression is valid for $4 < M < 7,3$ and for $3 \text{ km} < R < 200 \text{ km}$.

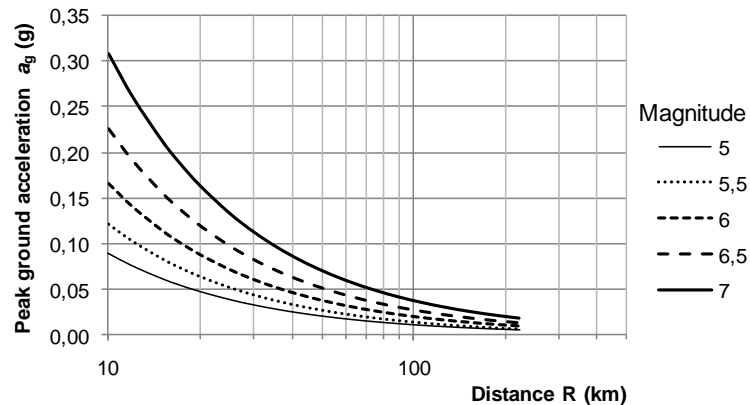

Fig. 1.2.2 Attenuation relationship for peak ground acceleration proposed by Ambraseys (1996)

From the figure, it is clear that the ground acceleration increases with the Magnitude and decreases sharply with the Distance.

1.2.4.1 Horizontal elastic spectra

The ground motion is described in EN1998-1 by the elastic ground acceleration response spectrum S_e , denoted as the “elastic response spectrum”.

The **basic shape** of the horizontal elastic response spectrum, normalised by a_g , is as presented in Fig.1.2.3 (reproduced from EN 1998-1).

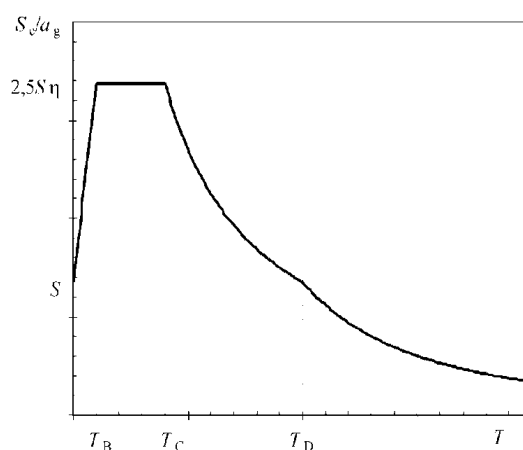

Fig. 1.2.3 Basic shape of the elastic response spectrum in EN 1998-1

The horizontal seismic action is described by two orthogonal components, assumed as independent and being represented by the same response spectrum.

The basic spectral shape is composed by four branches:

- o Very low period branch, from peak ground acceleration to the constant acceleration branch
- o Constant acceleration
- o Constant velocity
- o Constant displacement

These branches are separated by three “corner” periods: T_B , T_C and T_D which are Nationally Determined Parameters (NDPs), allowing the adjustment of the spectral shape to the seismo-genetic specificities of each country.

In this respect it is worth mentioning that EN 1998-1 foresees the possibility of using more than one spectral shape for the definition of the seismic action.

This is appropriate when the earthquakes affecting a site are generated by widely differing sources (for instance in terms of Magnitudes and Distances). In such cases the possibility of using more than one shape for the spectra should be considered to enable the design seismic action to be adequately represented. Then, different values of a_g shall normally be required for each type of spectrum and earthquake (i.e. more than one zonation map is required).

Again, just with illustrative purposes of the influence of Magnitude and Epicentral Distance on the response spectrum shape, Figs. 1.2.4 and 1.2.5 present the spectra derived from the spectral attenuation expressions proposed by Ambraseys (1996), respectively different Magnitudes and constant Distance and for different Distance and constant Magnitude.

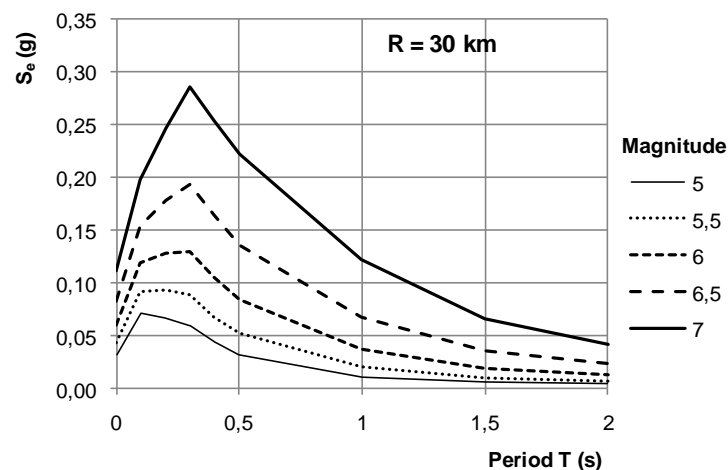

Fig. 1.2.4 Effect of Magnitude on spectral shape (for constant Distance) (Ambraseys, 1996)

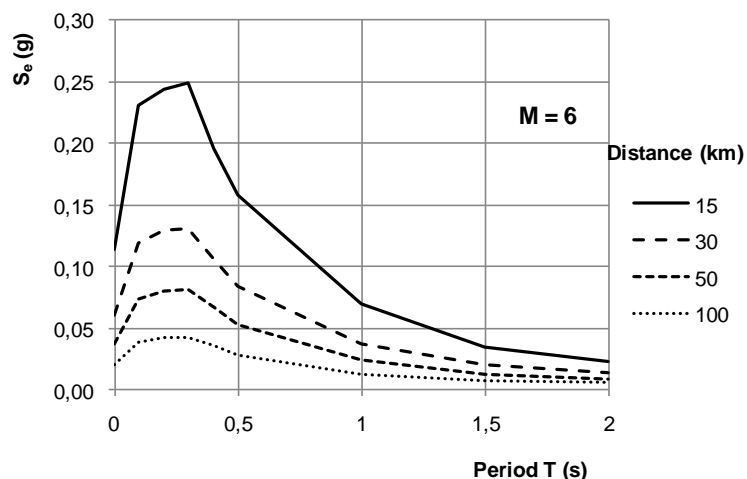

Fig. 1.2.5 Effect of Distance on spectral shape (for constant Magnitude) (Ambraseys, 1996)

The effect is generally similar to the one referred for the peak ground acceleration but it is clear that increasing the Magnitudes has a more marked effect on the longer period spectral ordinates, provoking the shift of the spectrum to the long period range.

It is worth noting that this is akin to the larger increase (in comparison with acceleration) of the peak ground velocities (and also peak ground displacements) that is associated with larger Magnitudes.

Accordingly, to enable a wider choice to National Authorities, EN 1998-1 includes, as recommended spectral shapes, **two types of earthquakes**: Type 1 and Type 2.

In general Type 1 should be used. However, if the earthquakes that contribute most to the seismic hazard defined for the site have a surface-wave magnitude, M_s , not greater than 5,5, then Type 2 is recommended.

The recommended spectral shapes (normalised by a_g) for the two types of seismic action (Type 1 and Type 2) are presented in Fig. 1.2.6.

The shift of the Type 1 spectrum (Larger Magnitudes) towards the longer periods, in comparison with the Type 2 spectrum (Smaller Magnitudes) is clear.

To further illustrate this aspect, the figure also depicts the normalised spectral shapes derived with the attenuation relationships proposed by Ambraseys (1996), as presented in Fig. 1.2.4. It is clear that the spectrum for Magnitude $M = 5,5$ agrees well with the shape recommended for the Type 2 seismic action, whereas, the recommended shape for the Type 1 action agrees quite well with the spectral shape derived for Magnitude $M = 7$.

The comparison is made for an epicentral distance of $R = 30$ km but for other distances the agreement would be similar.

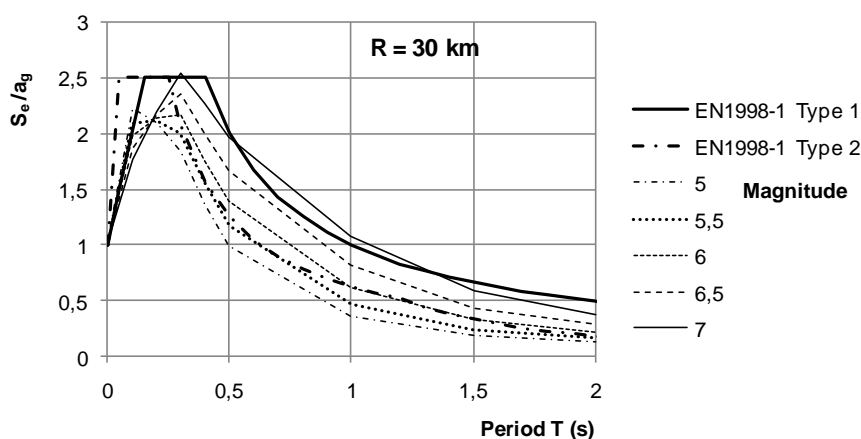

Fig. 1.2.6 Recommended spectral shapes for Type and Type 2 seismic action in EN 1998-1 and illustration of the effect of Magnitude on normalised spectral shape (rock ground conditions)

As presented in 1.2.3 above, the underlying ground conditions at a site strongly influence the earthquake vibration at the surface and correspondingly the peak ground acceleration and the response spectrum shape.

In EN 1998-1 this is acknowledged by the use of a **soil factor** S , also a NDP, that multiplies the design ground acceleration (a_g) derived from the zonation map.

It is worth recalling at this point that $a_g = a_{gR} \cdot \gamma_I$ (i.e. a_g already incorporates the **importance class** of the structure (see 1.2.2.2)) and that a_{gR} should be taken from the zonation map that is established for **rock type ground conditions** and for the **reference return period** chosen by the National Authorities for the No-collapse requirement for ordinary structures.

Furthermore, in EN 1998-1 the ground conditions influence the values of the corner periods T_B , T_C and T_D and correspondingly the spectral shape.

The recommended spectral shapes for the two types of seismic action (Type 1 and Type 2) are presented in Figs. 1.2.7 and 1.2.8 illustrating the effect of the different ground types A, B, C, D and E.

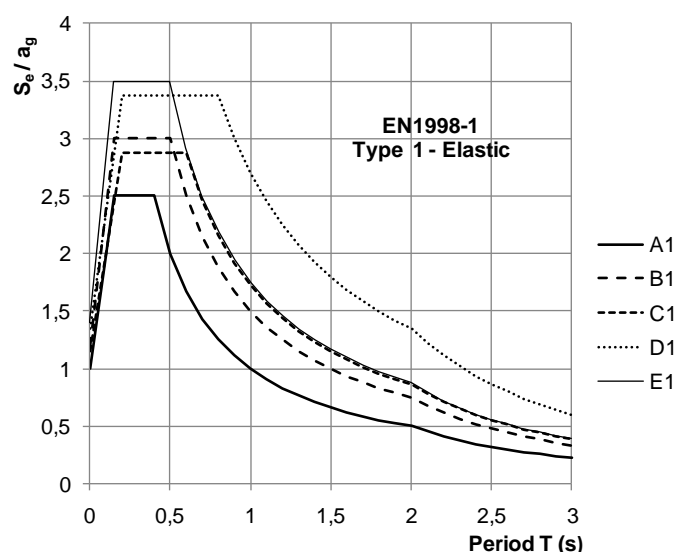

Fig. 1.2.7 Recommended spectral shapes for Type 1 seismic action ($M_s \geq 5,5$) for various ground types

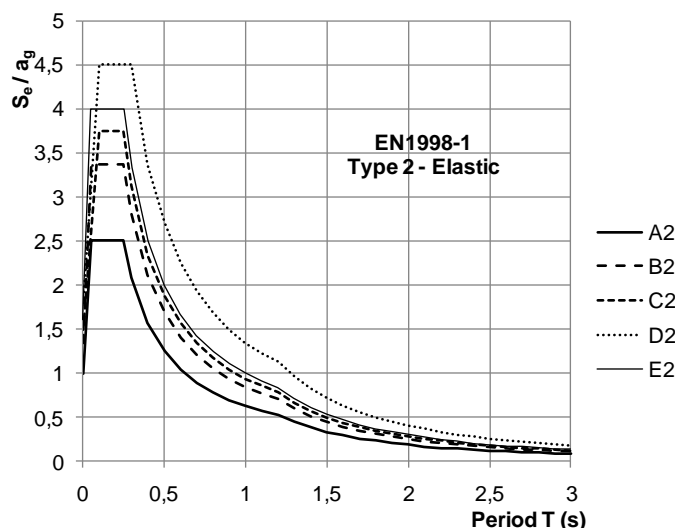

Fig. 1.2.8 Recommended spectral shapes for Type 2 seismic action ($M_s < 5,5$) for various ground types

The recommended value for the soil factor is $S = 1$ for Ground Type A (Rock) and range from $S = 1,2$ to $1,4$ for the other ground types in case of Type 1 response spectra or from $S = 1,35$ to $1,8$ in case of Type 2 response spectra.

In this respect it is worth mentioning that in the Portuguese National Annex, non constant values of S have been adopted. In fact, the value of the S factor decreases as the ground acceleration increases in the different seismic zones. This accounts for the effect of decreased soil amplifications in case of very high soil accelerations due to the triggering of nonlinear behaviour associated with larger soil strains and also higher energy dissipation.

The solution adopted in the Portuguese National Annex for the definition of S is depicted in Fig. 1.2.9 and is based on the values of S_{max} which are presented in the Annex for the various ground types. These values range from $1,35$ to $2,0$ and are independent of the response spectra type.

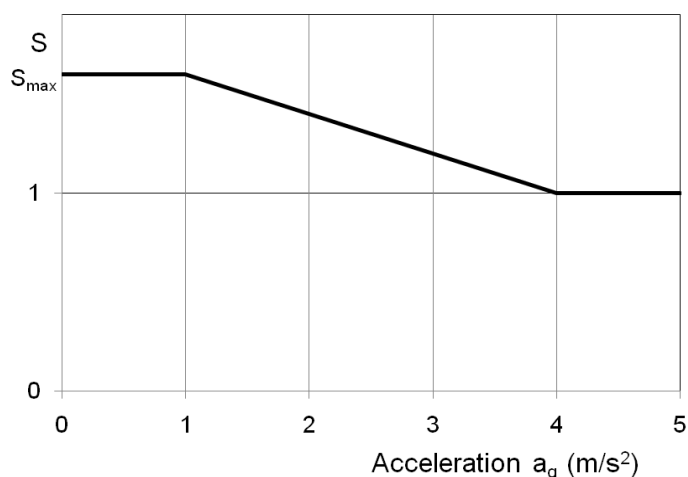

Fig. 1.2.9 Dependence of the soil factor S on the design acceleration in the Portuguese National Annex of EN 1998-1

In EN 1998-1 the spectral amplification (from peak ground acceleration to the acceleration at the constant acceleration branch) is fixed at 2,5 and is consistent with **5% viscous damping**. It is however anticipated that the spectral shape may be adjusted for other damping values with the correction factor η given by:

$$\eta = \sqrt{10/(5 + \xi)} \geq 0,55 \quad (1.5)$$

where ξ is the viscous damping ratio of the structure, expressed as a percentage. The correction factor is depicted in Fig 1.2.10

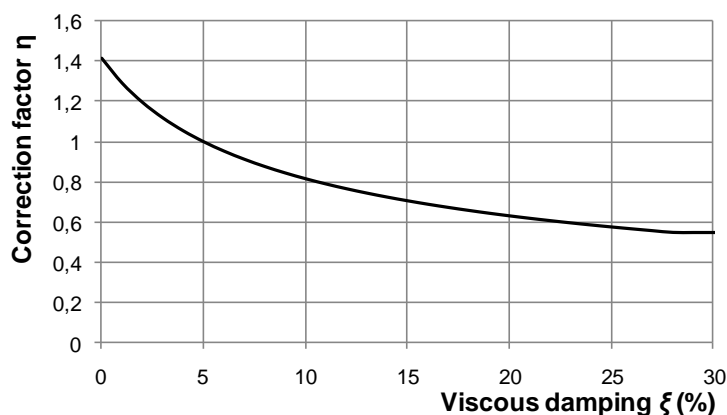

Fig. 1.2.10 Spectral ordinates correction factor η as function of the viscous damping

This correction factor is applied directly to the spectral ordinates (for the reference value of 5% damping) for $T \geq T_B$.

For the first branch of the spectrum, i.e. if $0 \leq T < T_B$, the application of the damping correction factor η is made in such a way that for $T = 0$ there is no correction and for $T = T_B$ the correction is applied fully. This is to ensure that at $T = 0$, where the spectral ordinate represents the peak ground acceleration, there is no effect of the damping value.

1.2.4.2 Vertical elastic spectra

The vertical component of the ground motion is described in EN1998-1 by an elastic ground acceleration response spectrum S_{ve} , denoted as the “vertical elastic response spectrum”.

The spectrum is anchored to the value of the peak vertical acceleration a_{vg} . For each seismic zone this vertical acceleration is given by the ratio a_{vg}/a_g which is a NDP, to be defined by the National Authorities.

The basic shape of the spectrum for the vertical component is similar to the one recommended for the horizontal components, including four branches (limited by the corner periods T_B , T_C and T_D , specific of the vertical action). However, in this case, the spectral amplification factor is 3,0 instead of the value 2,5 adopted for the horizontal spectra.

Similarly to the horizontal components, two spectral shapes are recommended in EN 1998-1 for the vertical components, one for Type 1 and another for Type 2 earthquakes.

The recommended values for a_{vg}/a_g are $a_{vg}/a_g = 0,9$ for seismic action Type 1 (large Magnitude) and $a_{vg}/a_g = 0,45$ for seismic action Type 2 (small Magnitude) and the recommended shapes for the two types of seismic action are presented in Fig. 1.2.11, normalised by the horizontal acceleration a_g .

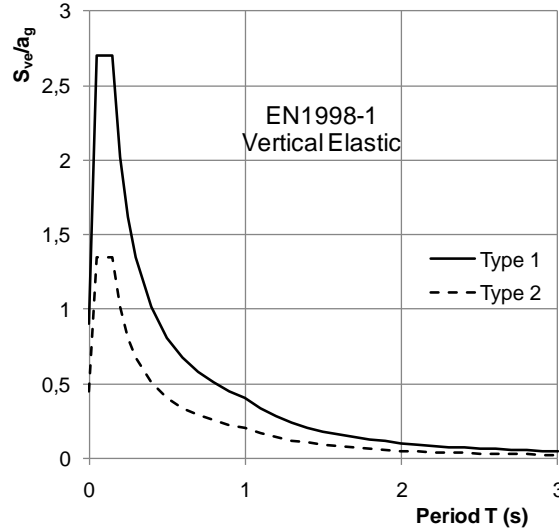

Fig. 1.2.11 Recommended spectral shapes for the vertical elastic spectra

Furthermore, it should be mentioned that, contrary to what is indicated for the horizontal components, it is considered that the vertical ground motion is not very much affected by the underlying ground conditions and so no use of the soil factor S is made.

1.2.4.3 Ground displacement and displacement spectra

As a final remark regarding the definition of the seismic ground motion, it should be mentioned that EN 1998-1 indicates that the design ground displacement d_g , corresponding to the design ground acceleration a_g , may be estimated by the following expression:

$$d_g = 0,025 \cdot a_g \cdot S \cdot T_C \cdot T_D \quad (1.6)$$

with a_g , S , T_C and T_D as defined above.

Besides the ground displacement, EN 1998-1 includes an Informative Annex presenting the Elastic Displacement Response Spectrum $S_{De}(T)$.

It represents the relative displacement (of the structure to the ground) and is intended for structures of long vibration periods but it also covers the shorter period range.

In fact, up to the constant displacement branch of the spectrum, a direct conversion of the elastic acceleration spectrum $S_e(T)$ into $S_{De}(T)$ is made with the expression:

$$S_{De}(T) = S_e(T) \left[\frac{T}{2\pi} \right]^2 \quad (1.7)$$

Beyond the constant displacement branch, two additional corner periods, T_E and T_F , are considered for the definition of the relative displacement response spectrum.

The corner period T_E corresponds to the end of the constant displacement branch. Then, in between T_E and T_F , the spectral ordinates decrease and tend to the ground displacement d_g . Beyond that it becomes constant and equal to d_g (it may be noticed that at very large periods, corresponding to very flexible single degree of freedom oscillators, the relative displacement is exactly the ground displacement, since the mass of the oscillator remains motionless).

In the annex of EN 1998-1 the recommended values for T_E are $T_E = 4,5$ s for ground type A, $T_E = 5,0$ s for ground type B and $T_E = 6,0$ s for ground types C to E. A common value of $T_F = 10$ s is recommended for all ground types.

The shape of the elastic displacement response spectra for the various ground types and for seismic action Type 1 is presented in Fig. 1.2.12. The spectra presented are normalised by the ground displacement for ground type A, allowing to perceive the influence of the ground type on the seismic ground displacement. In fact, the ground displacement, in relative terms, is represented at the right hand side of the diagram (beyond $T = 10$ s) and it is clear that it increases sharply for the softer ground types.

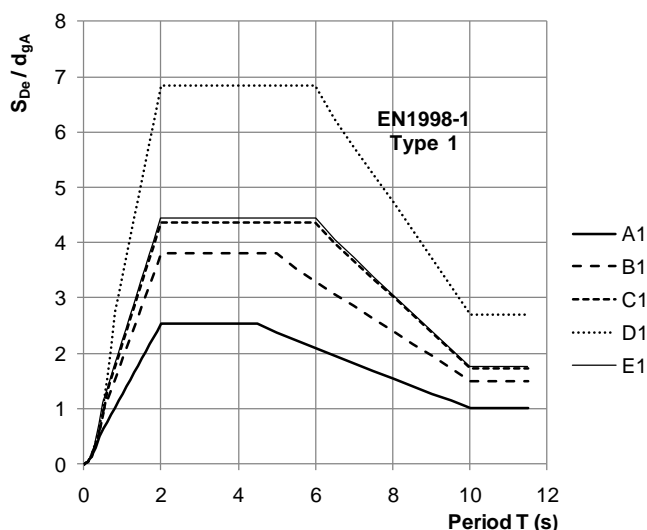

Fig. 1.2.12 Recommended displacement spectral shapes for Type 1 seismic action for various ground types

1.2.4.4 Design spectra for elastic analysis

As indicated before, seismic design according to EN 1998-1 relies on the (stable) energy dissipation capacity of the structure and in operational terms (in a force-based design approach) such possible trade-off between resistance and ductility is reflected by the use of behaviour factors for the establishment of Design Spectra suitable for an elastic analysis.

The ordinates of these Design Spectra are reduced in comparison with the corresponding elastic spectra (which essentially are intended to represent the actual ground vibration) and such reduction is made by the behaviour factor (which is a divisor in the definition of the design spectrum).

In the context of EN 1998-1 the behaviour factor q is taken as “an approximation of the ratio of the seismic forces that the structure would experience if its response was completely elastic with $\xi = 5\%$ viscous damping, to the seismic forces that may be used in the design, with a conventional elastic analysis model, still ensuring a satisfactory response of the structure”.

The values of the behaviour factor q , which also account for the influence of the viscous damping being different from 5%, are given for various materials and structural systems according to the relevant ductility classes in the various Parts of EN 1998.

The value of the behaviour factor q may be different in different horizontal directions of the structure (depending on the structural system in each direction), although the ductility classification shall be the same in all directions

Hence EN 1998-1, besides the elastic response spectra discussed above, presents the so called Design Spectra for Elastic Analysis. In most of the period range, the ratio between the elastic

spectrum and the corresponding design spectrum is simply the value of the behaviour factor q as indicated above.

However, in the “extreme” period ranges adjustments to this general rule are introduced as follows:

- o In the very low period branch (from peak ground acceleration to the constant acceleration branch, i.e. up to T_B) a non-constant q value is adopted so that at $T = 0$ the q factor is taken as $q = 1,5$ (independently of the Ductility Class) whereas at the corner period T_B q is taken with the value for the relevant Ductility Class. It should be referred that the adoption of $q = 1,5$ at $T = 0$ reflects the assumption taken in EN 1998-1 that the q factor accounts both for the dissipation capacity as well as for the inherent over strength existing in all structures. This part of the q factor is assumed to be 1,5.
- o In the long period range the design spectrum is limited by a minimum value to safeguard against the use of very low base shear coefficients. The recommended value for this lower bound of the design spectra is $0,2 a_g$.

With these adjustments, the typical shape of the design spectra of EN 1998-1 is depicted in Fig. 1.2.13, for different values of the behaviour factor q (shapes for ground type C, normalised by a_g).

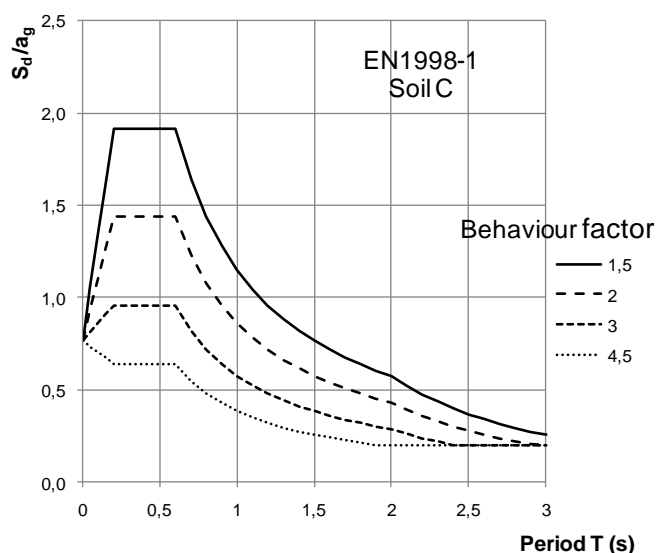

Fig. 1.2.13 Design spectra for various behaviour factor values for Type C ground type (with the recommended values of EN 1998-1)

The ordinate at $T = 0$ is 0,77 corresponding to the soil factor $S = 1,15$ (for ground type C) divided by 1,5 corresponding to the over strength ($1,15/1,5 = 0,77$). On the other hand, at the right hand side of the diagram, the effect of the cut-off by a minimum spectral value for design is apparent

It is important to stress that the values of the behaviour factor q also account for the influence of the viscous damping being different from 5%. Hence the damping correction factor η , presented above for the elastic spectra, should not be applied to the design spectra (otherwise the effect of damping differing from the 5% reference value would be accounted twice).

References

Ambraseys, N.N., Simpson, K.A., & Bommer, J.J. 1996. Prediction of horizontal response spectra in Europe. *Earthquake Engineering and Structural Dynamics*, **25**(4), 371–400.

CHAPTER 2

Introduction to the RC building example. Modeling and analysis of the design example

P. Fajfar and M. Kreslin

University of Ljubljana

2.1 Description of the building and of actions

In this chapter the modelling and the elastic analysis of the test building is described. First, the building structure and the actions (both horizontal seismic action and the associated vertical action) are described. In Section 2.2 the mathematical model, used in analyses, is explained. Sections 2.3 and 2.4 deal with the regularity and with the structural type of the building and the related behaviour factor. The main analysis method was the modal response spectrum analysis. The main results of the analysis are summarized in Section 2.5. For comparison, lateral force analysis was also performed. Some results are shown in the last section. All analyses were performed with the ETABS software (CSI 2002. ETABS. Integrated Building Design Software, Computers & Structures Inc. Berkeley). In all cases a spatial mathematical model was used.

2.1.1 DESCRIPTION OF THE BUILDING

The investigated building is a multi-storey reinforced concrete structure. The elevation of the building and two floor plans (typical and basement level) are shown in Figs. 2.1.1 and 2.1.2. The building has 6 storeys above ground level (level 0) and two basement storeys. The total height of the building above the basement is 19 m. The height of the first storey (between levels 0 and 1) amounts to 4 m, whereas the heights of other storeys are equal to 3.0 m. In the basement, there are peripheral walls. The dimensions of the basement floors are 30m x 21 m, whereas the area of other floors (above the level 0) is smaller. It amounts to 30m x 14 m.

The structural system consists of walls and frames. The cross sections of the construction elements (beams, columns and walls) are plotted in Fig. 2.1.1. The slab is 0.18 m thick. Footings with tie beams represent the foundation.

Concrete C25/30 is used. The corresponding modulus of elasticity amounts to $E_{cm} = 31\text{GPa}$ (EN 1992/Table 3.1). Poisson's ratio was taken equal to $\nu = 0$ (cracked concrete) according to EN 1992/3.1.3. Steel S500 Class C is used. The structure will be designed for ductility class DCM.

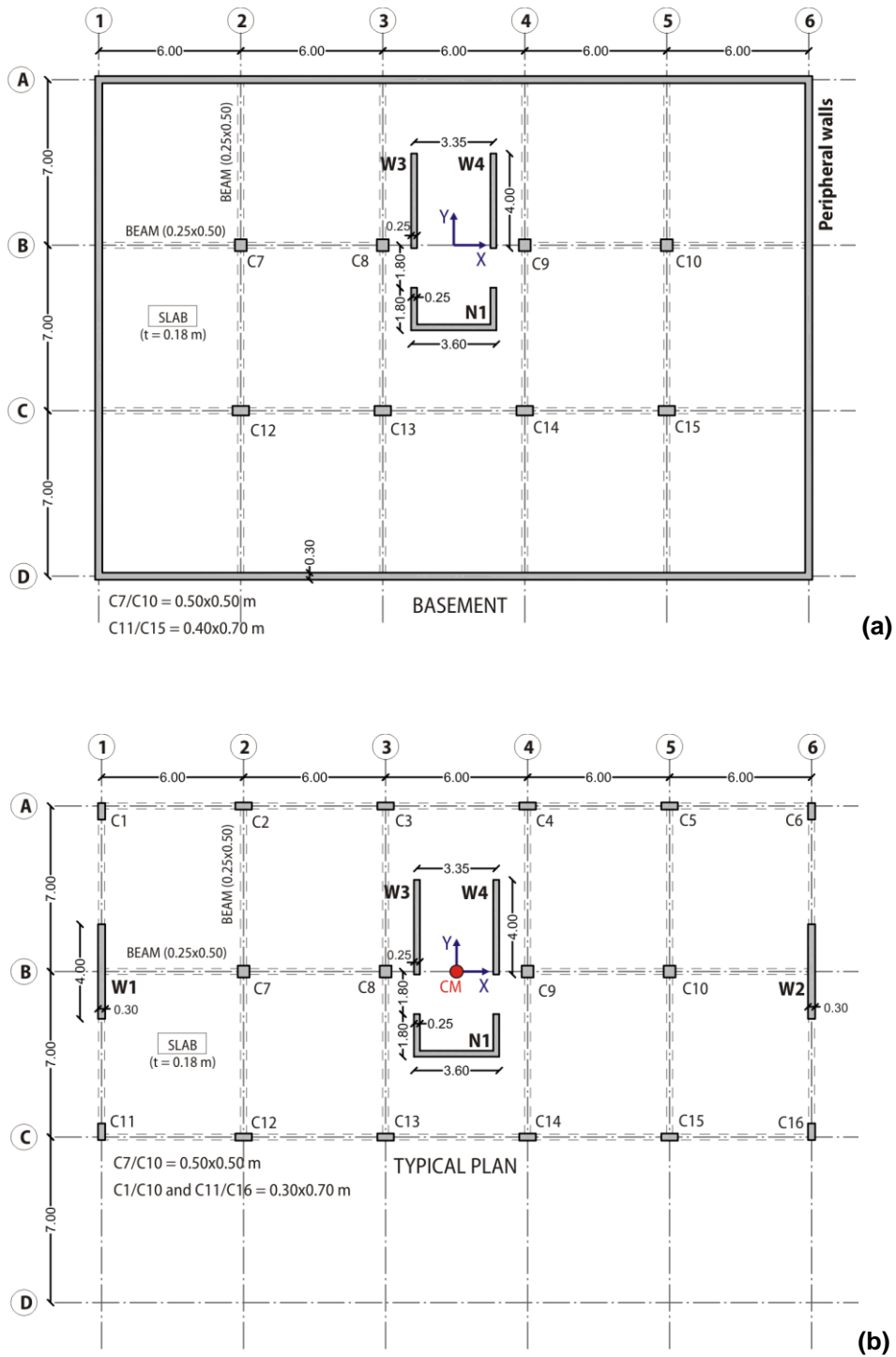

Figure 2.1.1 Floor plan of the building: (a) basement levels and (b) levels above 0. The X- and Y-axes as well as the origin of the global coordinate system and the centre of mass (CM) are marked

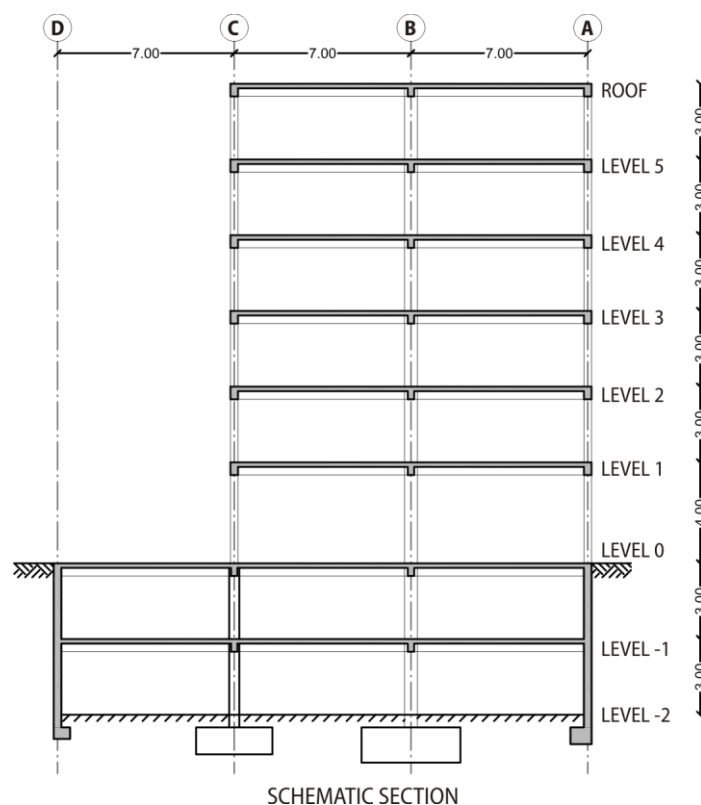

Figure 2.1.2 Schematic cross-section of the building

2.1.2 ACTIONS

2.1.2.1 Seismic actions

The seismic action is represented by the **elastic response spectrum**, Type 1 ($M_s > 5.5$, EN 1998-1/3.2.2.2(2)P) for soil B (EN 1998-1/Table 3.1). The reference peak ground acceleration amounts to $a_{gR} = 0.25g$. The values of the periods (T_B , T_C , T_D) and of the soil factor (S), which describe the shape of the elastic response spectrum, amount to $T_B = 0.15s$, $T_C = 0.5s$, $T_D = 2.0s$ and $S = 1.2$ (EN 1998-1/Table 3.2). The building is classified as importance class II (EN 1998-1/Table 4.3) and the corresponding importance factor amounts to $\gamma_I = 1.0$ (EN 1998-1/4.2.5(5)P). Therefore the peak ground acceleration is equal to the reference peak ground acceleration $a_g = \gamma_I^* a_{gR} = 0.25g$. Using the equation in EN 1998-1/3.2.2.2 the elastic response spectrum was defined for 5% damping.

For the design of the building the **design response spectrum** is used (i.e. elastic response spectrum reduced by the behaviour factor q). Determination of the behaviour factor q , which depends on the type of the structural system, regularity in elevation and plan, and ductility class, is described in Section 2.4. It amounts to 3.0. The design spectrum for elastic analysis was defined using expressions in EN 1998-1/3.2.2.5(4)P. The elastic response spectrum and the design response spectrum ($q = 3.0$) are plotted in Figure 2.1.3.

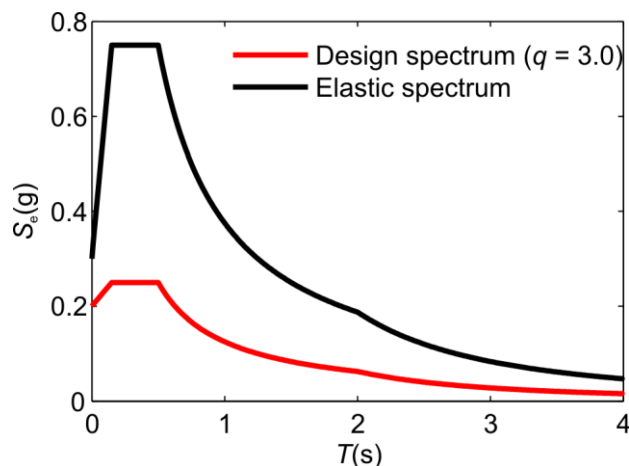

Figure 2.1.3 Elastic and design response spectrum

2.1.2.2 Vertical actions

In a seismic design situation the vertical actions (permanent loads “G” and variable-live loads “Q”) have to be taken into account (see section 2.5.8). The permanent loads “G” are represented by the self weight of the structure and additional permanent load. For later load the uniformly distributed load equal to 2 kN/m^2 is assumed. In the case of investigated building (which represents an office building – category B (EN 1991/Table 6.1)), the variable-live load in terms of uniformly distributed load amounts to 2 kN/m^2 (EN 1991/Table 6.2). The variable-live loads are, in a seismic design situation, reduced with a factor of $\psi_{2i} = 0.3$ (EN 1990/Table A.1.1).

Based on the unit weight of the concrete ($\gamma = 25 \text{ kN/m}^3$) and on the geometry of the structure, the self weight of the beams and plates in terms of uniform surface loads was defined. It amounts to 5.23 kN/m^2 for all levels. Adding the additional permanent load (2 kN/m^2), the total vertical action of the permanent loads “G” amounts to $5.23 + 2 = 7.23 \text{ kN/m}^2$. The self weight of the vertical elements (columns and walls) was automatically generated in program ETABS.

The uniform surface loads (corresponding to permanent loads “G” and to variable-live loads “Q”) were distributed to the elements with regard to their influence areas. The uniform surface loads were converted to uniform line loads for beams and to concentrated loads for walls (interior walls W3, W4, N1, part of walls modelled as columns WB1, WB2, WCOR). The uniform line load was calculated as a product of the influence area of the beams and the uniform surface load, divided by the length of the beam. The concentrated load represents the product of the influence area and the uniform surface load.

2.1.2.3 Floor masses and mass moments of inertia

The floor masses and mass moments of inertia are determined according to EN 1998-1/3.4.2. Complete masses resulting from the permanent load (self weight of the structure + 2 kN/m^2) are considered, whereas the masses from the variable-live load are reduced using the factor $\psi_{Ei} = \varphi \cdot \psi_{2i}$. Factor ψ_{2i} amounts to 0.3 in the case of an office building (EN 1990/Table A.1.1). Factor φ is equal to 1.0 for the roof storey and 0.5 for other storeys (EN 1998-1/4.2.4). The mass moment of inertia (MMI) was calculated as

$$MMI = m \cdot I_s^2 \quad (2.1)$$

where m is storey mass and I_s is the radius of the gyration of the floor mass determined by equation (2.1). It amounts to $I_s = 9.56 \text{ m}$ for storeys above level 0. The floor masses and mass moments of inertia are shown in Table 2.1.1. In the analysis, only masses above the top of the basement (above

the level 0) are taken into account. The total mass of the building (above the level 0) is equal to 2362 ton. The masses in basement do not influence the results due to extremely small deformations of walls. Therefore these masses were neglected in order to facilitate the understanding of some results (e.g. effective masses, base-shear ratio).

Table 2.1.1 Floor masses and mass moments of inertia

Level	Storey mass (ton)	Moment of inertia (ton*m ²)
ROOF	372	33951
5	396	36128
4	396	36128
3	396	36128
2	396	36128
1	408	37244
Σ =	2362	

2.2 Structural model

2.2.1 GENERAL

The program ETABS was used for analysis. A three-dimensional (spatial) structural model is used. The major and auxiliary axes in plan are shown in Figure 2.1.1. The origin of the global coordinate system is located in the centre of the upper storeys (above the level 0). Denotations for the major axis and for the storey levels are shown in Figs. 2.1.1 and 2.1.2. The structural model fulfils all requirements of EN 1998-1/4.3.1-2. The basic characteristics of the model are as follows:

- o All elements, including walls, are modelled as line elements. The peripheral walls are modelled with line elements and a rigid beam at the top of each element as described in section 2.2.1.2.
- o Effective widths of beams are calculated according to EN 1992. Two different widths for interior beams and another two for exterior beams are used. More data are provided in section 2.2.1.1.
- o Rigid offset for the interconnecting beams and columns elements are not taken into account. Infinitely stiff elements are used only in relation to walls (walls W1 and W2 in axes 1 and 6, see Figure 2.1.1).
- o All elements are fully fixed in foundation (at Level -2).
- o Frames and walls are connected together by means of rigid diaphragms (in horizontal plane) at each floor level. (EN 1998-1/4.3.1(3)) The slabs are not modelled.
- o Masses and moments of inertia of each floor are lumped at centres of masses (EN 1998-1/4.3.1(4)). They were calculated from the vertical loads corresponding to the seismic design situation (EN 1998-1/4.3.1(10), see section 2.1.2.3). Only masses above the top of the peripheral walls (above the level 0) are taken into account.
- o The cracked elements are considered (EN 1998-1/4.3.1(6)). The elastic flexural and shear stiffness properties are taken to be equal to one-half of the corresponding stiffness of the uncracked elements (EN 1998-1/4.3.1(7)), i.e. the moment of inertia and shear area of the

uncracked section were multiplied by factor 0.5. Also the torsional stiffness of the elements has been reduced. Torsional stiffness of the cracked section was set equal to 10% of the torsional stiffness of the uncracked section.

- o Infills are not considered in the model.
- o The accidental torsional effects are taken into account by means of torsional moments about the vertical axis according to EN 1998/4.3.3.3.3 (see section 2.5.3)

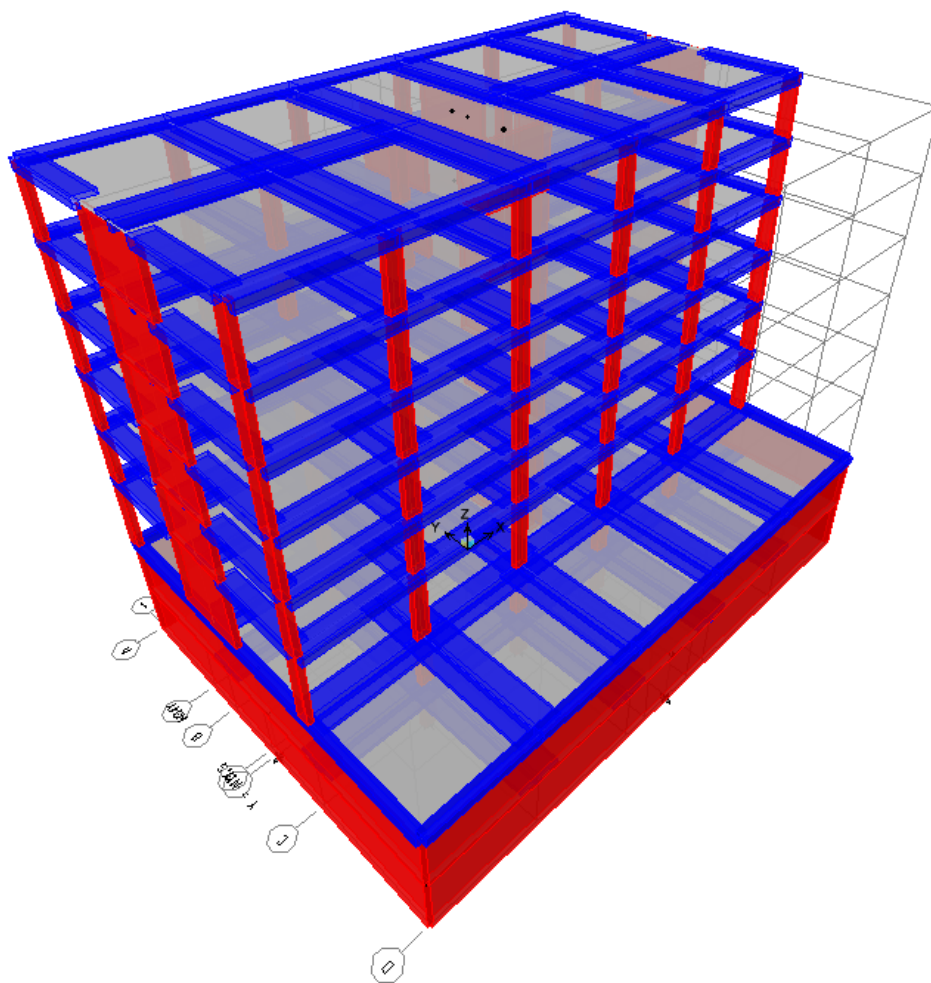

Figure 2.2.1 Structural model

2.2.1.1 Effective widths of beams

The effective widths of beams b_{eff} were calculated according to EN 1992/5.3.2.1. Determined were two different widths for interior beams (BINT1 and BINT2, Fig 2.2.2) and two widths for exterior beams (BEXT1 and BEXT2 Fig. 2.2.2). A constant width was adopted over the whole span. In such a case the value of the b_{eff} applicable for the span should be used (EN 1992/5.3.2.1(4)). The corresponding l_o (distance between points of zero moment) amounts to 70% of the element length (EN 1992, Figure 5.2). The values of the effective widths b_{eff} are shown in Fig. 2.2.2. They are rounded to 5 cm.

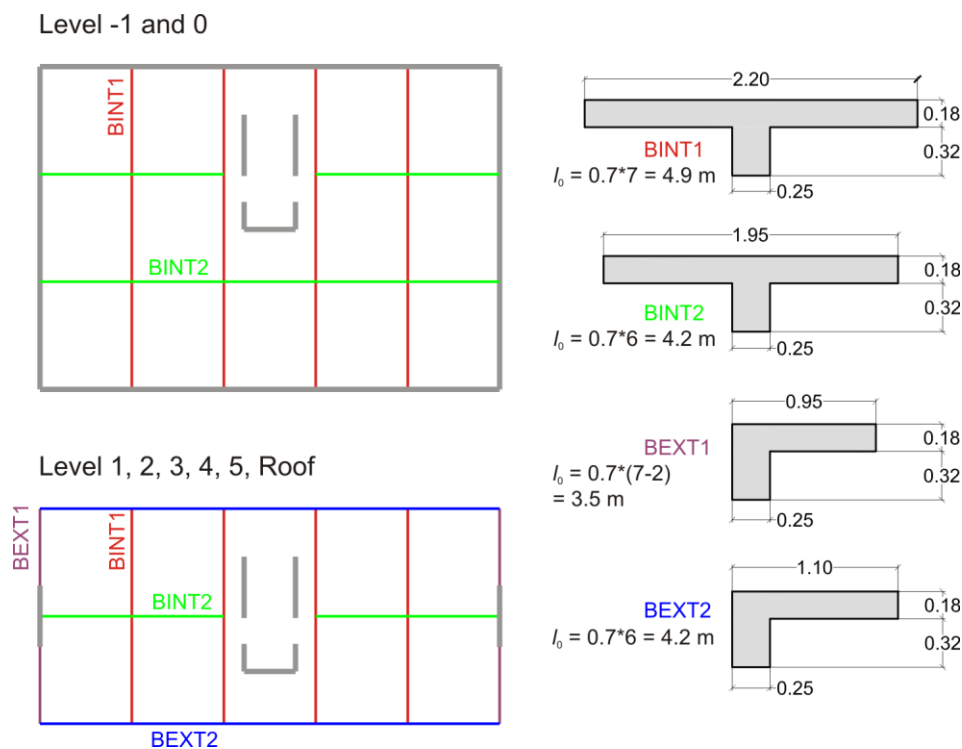

Figure 2.2.2 Effective widths of the beams

2.2.1.2 Modelling the peripheral walls

The peripheral walls are modelled with line elements and a rigid beam at the top of each element.

The rigid beams (denotation RB in ETABS) are modelled as rectangular cross section 0.5/0.5 m. A large value for the beam stiffness was obtained by multiplying all characteristics (area, shear area, moment of inertia, torsional constant) with a factor of 100. Eight fictitious columns in X direction (denotation WB1), four columns in Y direction (WB2) and four corner columns (WBCOR, see Figure 2.2.3) are used for the modelling of peripheral walls. For each column, the area, the moment of inertia about the strong axis and the shear area in the direction of the strong axis are calculated as a part of the respective characteristic of the whole peripheral wall in the selected direction (WB1* in X direction, WB2* in Y direction). The cross sections of the walls are 30*0.3 m and 21*0.3 m in the case of WB1* and WB2*, respectively. The moment about the weak axis and the shear area in the direction of weak axes are determined using the effective width of the fictitious column. We arbitrarily assumed that the effective width for columns WB1 and WB2 amounts to 4 m, which is the same value as the width of the walls W1-W4 in the storeys above basement. The torsional stiffness of the columns is neglected. In the case of the column WB1, the area, shear area and moment of inertia about strong axes represent 1/5 of the values corresponding to the whole wall WB1*, whereas in the case of the column WB2, they amount to 1/3 of the values of the wall WB2*. For the corner columns (WBCOR), the area represents the sum of the proportional values of both walls (WB1* and WB2*), the shear area ($A_{s,22}$) and the moment of inertia about the axis 3 originates from the wall WB1*, whereas the shear area ($A_{s,33}$) and the moment about the axis 2 originate from the wall WB2*. Local axes (2 and 3) of all columns are oriented in such a way, that the axis 2 coincides with the global axis X and the axis 3 with the global axis Y.

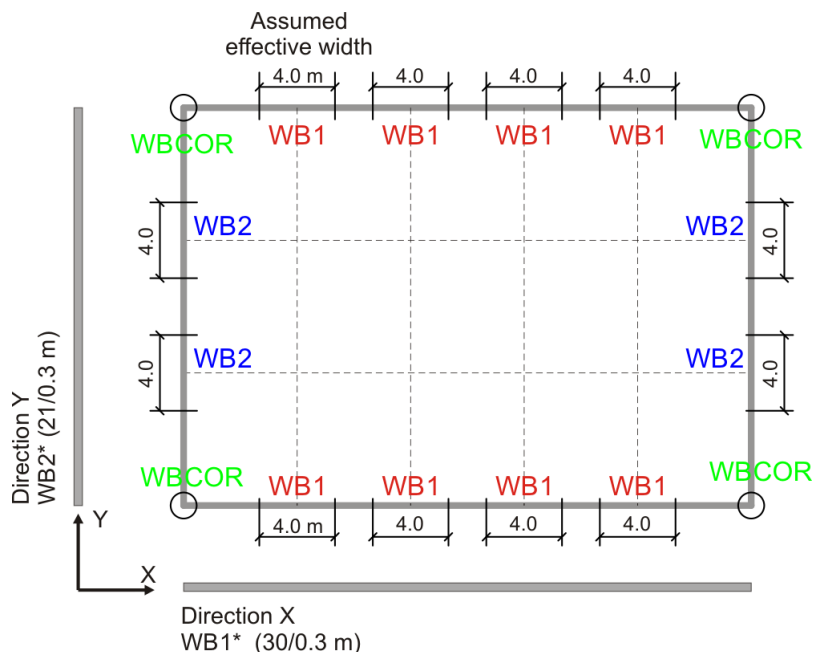

Figure 2.2.3 Modelling the peripheral walls

2.3 Structural regularity

Regularity of the structure (in elevation and in plan) influences the required structural model (planar or spatial), the required method of analysis and the value of the behaviour factor q (EN 1998-1/4.2.3.1).

As shown in this section, the test structure can be categorized as being regular in elevation and in plan. A lot of work has to be done to check the criteria for regularity in plan (see section 2.3.1) and, in practice, a designer may wish to avoid this work by assuming that the structure is irregular in plan. (Ir)regularity in plan may influence the magnitude of the seismic action (via the overstrength factor α_u/α_1). In the case of the investigated building the overstrength factor does not apply and there is no difference between seismic actions for a plan-regular and plan-irregular building. The test structure is regular also in elevation, if we do not consider the irregularity due to basement. For a structure regular in plan and in elevation, the most simple approach can be applied, i.e. a planar model can be used and a lateral force method can be performed. Moreover, the reference value of the basic behaviour factor q_0 can be used (see EN 1998-1/Table 4.1). Nevertheless, in this report, the standard (i.e. spatial) model and the standard (i.e. modal response spectrum) analysis will be used.

2.3.1 CRITERIA FOR REGULARITY IN PLAN

In general, the regularity in plan can be checked when the structural model is defined. The criteria for regularity in plan are described in EN 1998-1 (4.2.3.2)

- o the slenderness of the building shall be not higher than 4 ($\lambda = L_{max}/L_{min}$),
- o the structural eccentricity shall be smaller than 30% of the torsional radius ($e_{0X} \leq 0.30r_x$, $e_{0Y} \leq 0.30r_y$) and
- o the torsional radius shall be larger than the radius of the gyration of the floor mass in plan ($r_x \geq l_s$, $r_y \geq l_s$).

The slenderness of the test building is smaller than 4.0. It amounts to $\lambda = 1.43$ (30m/21m) in the case of the two basement levels and $\lambda = 2.14$ (30m/14m) for storey above level 0. Other two conditions (the structural eccentricity is smaller than 30% of the torsional radius and the torsional radius is larger than the radius of the gyration of the floor mass) are also fulfilled at each storey level in both horizontal directions (see Table 2.3.1). Determination of the structural eccentricity, the torsional radius and the radius of the gyration are described in sections 2.3.1.1, 2.3.1.2 and 2.3.1.3.

Building is categorized as being regular in plan in both directions.

Table 2.3.1 Criteria for regularity in plan according to EN 1998 (All quantities are in (m))

Level	Direction X				Direction Y			
	$ e_{0x} < 0.3 r_x$	r_x	$> l_s$	l_s	$ e_{0y} < 0.3 r_y$	r_y	$> l_s$	l_s
ROOF	0.00	3.81	12.71	9.56	0.93	4.96	16.54	9.56
LEVEL 5	0.00	3.80	12.66	9.56	1.06	5.10	16.99	9.56
LEVEL 4	0.00	3.78	12.59	9.56	1.25	5.27	17.56	9.56
LEVEL 3	0.00	3.77	12.57	9.56	1.49	5.52	18.38	9.56
LEVEL 2	0.00	3.81	12.69	9.56	1.77	5.90	19.65	9.56
LEVEL 1	0.00	3.96	13.21	9.56	2.09	6.43	21.44	9.56
LEVEL 0	0.00	5.76	19.21	10.57	0.00	4.75	15.82	10.57
LEVEL-1	0.00	5.54	18.48	10.57	0.00	4.77	15.91	10.57

2.3.1.1 Determination of the structural eccentricity (e_{0x} and e_{0y})

The structural eccentricity in each of the two orthogonal directions (e_{0x} and e_{0y}) represents the distance between the centre of stiffness (X_{CR} , Y_{CR}) and the centre of mass (X_{CM} , Y_{CM}). In general, it has to be calculated for each level. Centre of mass coincides with the origin of the global coordinate system at levels above 0. EN 1998 does not provide a procedure for determination of the centre of stiffness. One option for the determination of the structural eccentricity of level i is the use of equations

$$e_{0x,i} = \frac{R_{z,i}(F_{x,i}=1)}{R_{z,i}(M_i=1)} \quad \text{and} \quad e_{0y,i} = \frac{R_{z,i}(F_{y,i}=1)}{R_{z,i}(M_i=1)} \quad (2.2)$$

where $R_{z,i}(F_{y,i}=1)$ is the rotation of the storey i about vertical axes due to static load $F_{y,i}=1$ in Y direction, $R_{z,i}(F_{x,i}=1)$ is the rotation due to load $F_{x,i}=1$ in X direction, and $R_{z,i}(M=1)$ is the rotation due to torsional moment about the vertical axis. The forces $F_{x,i}$ and $F_{y,i}$ and the moment M are applied in the centre of mass in storey i . This can be done because rigid floors are assumed. The spatial structural model is needed for the determination of the structural eccentricity using this option.

In the case of the investigated building 24 (3*8 storeys) static load cases were defined. The results are shown in Table 2.3.2. Values $F_{x,i} = F_{y,i} = 10^6$ kN and $M = 10^6$ kNm were used as unit loads. The obtained coordinates of the centre of stiffness are measured from the centre of mass. The values in the global coordinated system are determined as $X_{CR,i} = X_{CM,i} + e_{0x,i}$, $Y_{CR,i} = Y_{CM,i} + e_{0y,i}$. In general, $e_{0x,i}$ and $e_{0y,i}$ may have positive or negative sign, but for the control of the plan regularity the absolute values are used.

Table 2.3.2 Coordinates of the centre of mass (X_{CM} , Y_{CM}), the rotation R_Z due to $F_X = 10^6$ kN, $F_Y = 10^6$ kN and $M = 10^6$ kNm, structural eccentricities (e_{0X} and e_{0Y}) and the coordinates of the centre of stiffness (X_{CR} , Y_{CR})

Level	X_{CM} (m)	Y_{CM} (m)	$R_Z(F_X)$ (rad)	$R_Z(F_Y)$ (rad)	$R_Z(M)$ (rad)	e_{0X} (m)	e_{0Y} (m)	X_{CR} (m)	Y_{CR} (m)
ROOF	0.00	0.00	-0.0761	0.0000	0.0818	0.00	-0.93	0.00	-0.93
LEVEL 5	0.00	0.00	-0.0570	0.0000	0.0537	0.00	-1.06	0.00	-1.06
LEVEL 4	0.00	0.00	-0.0418	0.0000	0.0333	0.00	-1.25	0.00	-1.25
LEVEL 3	0.00	0.00	-0.0277	0.0000	0.0186	0.00	-1.49	0.00	-1.49
LEVEL 2	0.00	0.00	-0.0151	0.0000	0.0086	0.00	-1.77	0.00	-1.77
LEVEL 1	0.00	0.00	-0.0059	0.0000	0.0028	0.00	-2.09	0.00	-2.09
LEVEL 0	0.00	-3.50	0.0000	0.0000	0.0002	0.00	0.00	0.00	-3.50
LEVEL-1	0.00	-3.50	0.0000	0.0000	0.0001	0.00	0.00	0.00	-3.50

2.3.1.2 Determination of the torsional radius (r_X and r_Y)

The torsional radius r_X (r_Y) is defined as the square root of the ratio of the torsional stiffness (K_M) to the lateral stiffness in one direction K_{FY} (K_{FX})

$$r_{X,i} = \sqrt{\frac{K_{M,i}}{K_{FY,i}}} \quad \text{and} \quad r_{Y,i} = \sqrt{\frac{K_{M,i}}{K_{FX,i}}} \quad (2.3)$$

The procedure for the determination of the torsional and lateral stiffness is similar to that for the determination of structural eccentricity (section 2.3.1.3). Three static load cases are defined for each storey level, and loads are represented by F_{TX} , F_{TY} and M_T , respectively. The forces and moment are applied in the centre of stiffness (in the case of the determination of the structural eccentricity, forces and moment were applied in centre of mass). The torsional and lateral stiffness for both directions are calculated as follows

$$K_{M,i} = \frac{1}{R_{Z,i}(M_{T,i} = 1)}, \quad K_{FX,i} = \frac{1}{U_{X,i}(F_{TX,i} = 1)}, \quad K_{FY,i} = \frac{1}{U_{Y,i}(F_{TY,i} = 1)} \quad (2.4)$$

where $R_{Z,i}(M_{T,i} = 1)$ is the rotation of the storey i about the vertical axis due to unit moment, $U_{X,i}(F_{TX,i} = 1)$ is the displacement at storey level i in direction X due to unit force F_{TX} and $U_{Y,i}(F_{TY,i} = 1)$ is the displacement in direction Y due to unit force F_{TY} .

The test structure has eight storeys therefore 24 static load cases were defined. Values $F_{TX,i} = F_{TY,i} = 10^6$ kN and $M_{T,i} = 10^6$ kNm were used as unit loads. The results are shown in Table 2.3.3.

Table 2.3.3 The displacements (U_x , U_y) and rotation (R_z) due to $F_{Tx} = 10^6$ kN, $F_{Ty} = 10^6$ kN and $M_T = 10^6$ kNm, the torsional (K_M) and lateral stiffness in both directions (K_{Fx} , K_{Fy}), and torsional radius (r_x , r_y)

Level	$U_x(F_{Tx})$ (m)	$U_y(F_{Ty})$ (m)	$R_z(M_T)$ (rad)	K_{Fx} (kN/m)	K_{Fy} (kN/m)	K_{MT} (kNm/rad)	r_x (m)	r_y (m)
ROOF	22.37	13.22	0.0818	4.47E+04	7.57E+04	1.22E+07	12.71	16.54
LEVEL 5	15.51	8.61	0.0537	6.45E+04	1.16E+05	1.86E+07	12.66	16.99
LEVEL 4	10.26	5.28	0.0333	9.74E+04	1.89E+05	3.00E+07	12.59	17.56
LEVEL 3	6.27	2.93	0.0186	1.59E+05	3.41E+05	5.39E+07	12.57	18.38
LEVEL 2	3.30	1.38	0.0086	3.03E+05	7.26E+05	1.17E+08	12.69	19.65
LEVEL 1	1.29	0.49	0.0028	7.75E+05	2.04E+06	3.56E+08	13.21	21.44
LEVEL 0	0.05	0.07	0.0002	2.22E+07	1.51E+07	5.56E+09	19.21	15.82
LEVEL-1	0.02	0.03	0.0001	4.78E+07	3.55E+07	1.21E+10	18.48	15.91

2.3.1.3 Determination of the radius of gyration of the floor mass in plan (I_s)

For checking the criteria for regularity in plan, the radius of the gyration of the floor mass (I_s) is also needed. It is defined as the square root of the ratio of the polar moment of inertia of the floor mass in plan to the floor mass. In the case of the rectangular floor area with dimensions l and b and with uniformly distributed mass over the floor, I_s is equal to

$$I_s = \sqrt{\frac{(l^2 + b^2)}{12}} \quad (2.5)$$

In our case, I_s amounts to 10.57 m for two basement levels and $I_s = 9.56$ m for storeys above level 0.

2.3.2 CRITERIA FOR REGULARITY IN ELEVATION

The test structure evidently fulfils all requirements for regularity in elevation stated in EN 1998-1/4.2.3.3 provided that only the upper part of the structure (above basement) is considered. Such a decision was made after the consultation with other authors of this publication and is supported by the fact that the global seismic actions at the basement levels are negligible. However, we believe that a different view is also legitimate. Considering the internal forces at the basement level (see section 2.6.4), one may treat that the structure conservatively as irregular.

2.4 Structural type of the building and behaviour factor

Structural type is the property of the building, but in general (especially in the case when the structure consists of walls and frames), it could not be defined without appropriate analyses. So, the mathematical (structural) model is needed for the determination of the structural type of the building.

According to EN 1998-1/5.1.2 the investigated building represents an **uncoupled wall system** in both horizontal directions. The structural system is considered as a wall system, when 65% (or more) of the shear resistance at the building base is taken by walls. However, the application of the shear resistance is not possible before the final design is made. EN 1998 allows that shear resistance may

be substituted by shear forces. In the case of the investigated building, base shear force (above the basement), taken by walls, amounts to about 72% base shear force of the whole structural system in direction X and 92% in direction Y.

Note that this classification was made after lively discussion between the authors of this publication. Intuitively, the investigated structural system is a wall-equivalent dual system. In the next version of EN 1998-1, more precise definitions of the structural type will be needed.

The behaviour factor q for each horizontal direction is calculated by equation (EN 1998-1/5.1)

$$q = q_0 \cdot k_w \quad (2.6)$$

where q_0 is the basic value of the behaviour factor and k_w is the factor associated with the prevailing failure mode in structural system with walls.

The test structure is classified as an uncoupled wall system in each of the two horizontal directions and will be designed as a DCM (Ductility Class Medium) structure. The corresponding q_0 amounts to 3.0 (EN 1998-1/Table 5.1). Factor q_0 depends also on the irregularity in elevation (EN 1998-1/5.2.2.2(3)). Because the structure is considered as regular in elevation, the value of q_0 remains unchanged. If the structure was classified as irregular in elevation, factor q_0 would be reduced for 20%. Factor k_w is equal to 1.0 (EN 1998-1, 5.2.2.2(11)) therefore the behaviour factor in both direction is equal to the basic value of the behaviour factor $q = q_0 = 3.0$.

2.5 Modal response spectrum analysis

2.5.1 GENERAL

- o Modal response spectrum analysis (abbreviation as RSA) was performed independently for the ground excitation in two horizontal directions.
- o Design spectrum (Figure 2.1.3) was used in both horizontal directions.
- o The CQC rule for the combination of different modes was used (EN 1998-1/4.3.3.3.2(3)).
- o The results of the modal analysis in both horizontal directions were combined by the SRSS rule (EN 1998-1/4.3.3.5.1(2a)).
- o The accidental torsional effects are taken into account by means of torsional moments about the vertical axis according to EN 1998-1/4.3.3.3.3 (see section 2.5.3).
- o The load combination of gravity and seismic loads was considered according to EN 1990/6.4.3.4 (see section 2.5.6)

2.5.2 PERIODS, EFFECTIVE MASSES AND MODAL SHAPES

The basic modal properties of the building are summarized in Table 2.5.1. The three fundamental periods of vibration of the building (considering the cracked elements sections) amount to 0.92, 0.68 and 0.51 s. The effective masses indicate that the first mode is predominantly translational in the X direction, the second mode is translational in the Y direction and the third mode is predominantly torsional. All three fundamental modes are shown in Figure 2.5.1.

In the modal response spectrum analysis all 18 modes of vibration were taken into account (the sum of the effective modal masses amounts to 100% of the total mass of the structure). Note that the first

six modes would be sufficient to satisfy the requirements in EN 1998-1/4.3.3.3(3) (the sum of the effective modal masses amounts to at least 90% of the total mass).

Table 2.5.1 The elastic periods (T), the effective masses and the effective mass moments (M_{eff})

Mode	T (s)	$M_{eff,UX}$ (%)	$M_{eff,UY}$ (%)	$M_{eff,MZ}$ (%)
1	0.92	80.2	0.0	0.2
2	0.68	0.0	76.3	0.0
3	0.51	0.2	0.0	75.2
4	0.22	15.0	0.0	0.2
5	0.15	0.0	18.5	0.0
6	0.12	0.2	0.0	17.6
$\Sigma M_{eff} =$		95.7	94.7	93.1

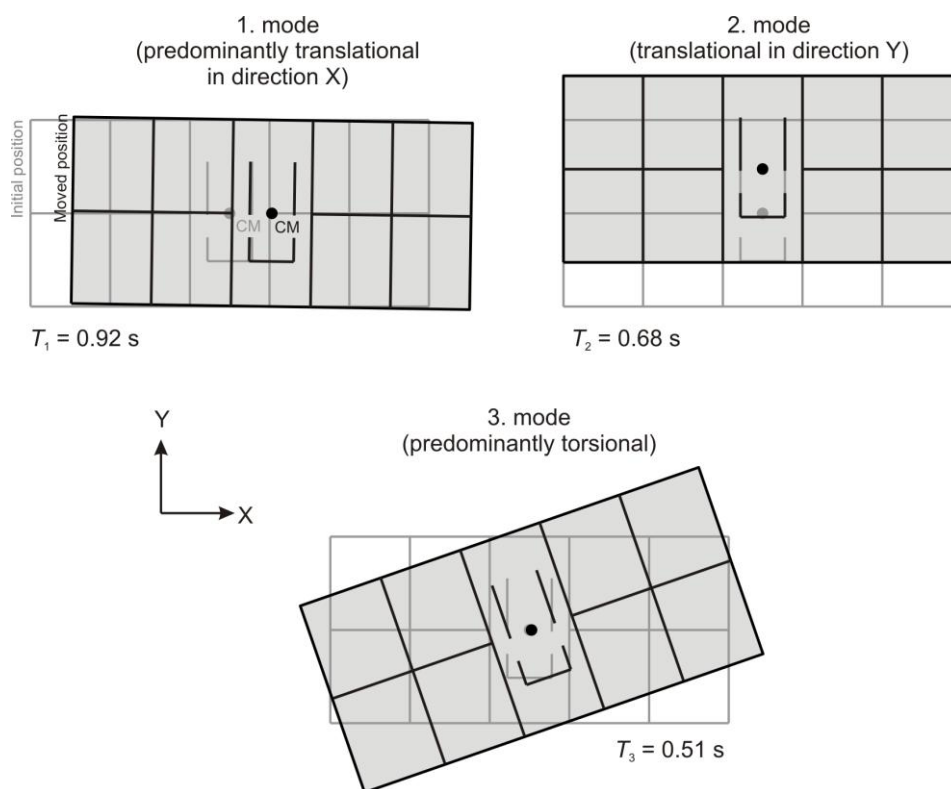

Figure 2.5.1 Three fundamental modes of vibration

2.5.3 ACCIDENTAL TORSIONAL EFFECTS

The torsional effects were considered by means of the torsional moments (M_{xi} and M_{yi}) about the vertical axis according to EN 1998-1/4.3.3.3. They are determined as a product of the horizontal forces in each horizontal direction (F_{xi} and F_{yi}) and the corresponding accidental eccentricity (e_{xi} and e_{yi}). The horizontal forces are obtained by the Lateral force method of analysis (see section 2.6.3). Accidental eccentricities are equal to 5% of the floor-dimensions (L_{xi} and L_{yi} , see Figure 2.1.1). Torsional moments as well as horizontal forces and accidental eccentricity are shown in Table 2.5.2. Only torsional moments above level 0 were considered in the analysis.

Table 2.5.2 Torsional moments

Level	L_{xi} (m)	L_{yi} (m)	e_{xi} (m)	e_{yi} (m)	F_{xi} (kN)	F_{yi} (kN)	$M_{xi} = F_{xi} \cdot e_{yi}$ (kNm)	$M_{yi} = F_{yi} \cdot e_{xi}$ (kNm)
ROOF	30	14	1.5	0.7	703	951	492	1426
5	30	14	1.5	0.7	630	852	441	1278
4	30	14	1.5	0.7	512	692	358	1039
3	30	14	1.5	0.7	394	533	276	799
2	30	14	1.5	0.7	276	373	193	559
1	30	14	1.5	0.7	162	220	114	329

The procedure for the combination of the torsional moments, representing the accidental eccentricity, and results obtained by modal response spectrum analysis (RSA) without considering accidental eccentricity, is not clearly defined in EN 1998. In this paper, two options of combination are shown.

In the first option, the envelope of the effects resulting from the four sets of the torsional moments ($+M_{xi}$, $-M_{xi}$, $+M_{yi}$, $-M_{yi}$) is added to the combined (SRSS) results of the seismic actions in two orthogonal directions obtained by RSA. The torsional moments due to horizontal loading in direction Y (M_{yi}) are larger than those in X direction (M_{xi}). Therefore, the final torsional effects are determined as the envelope of the torsional moments M_{yi} with positive and negative signs of loading.

In the second option, first, the effects resulting from the torsional moments due to seismic excitation in a single direction with positive and negative sign of loading are combined with the results of RSA for the same horizontal component of the seismic action. Then, the results for both directions with included torsional effects are combined by SRSS rule.

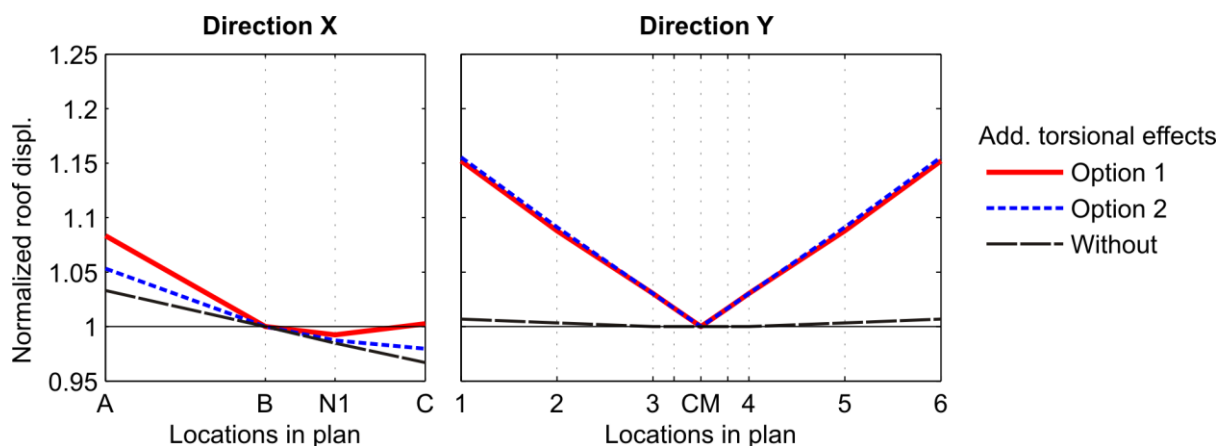

Figure 2.5.2 Torsional effects in terms of normalized roof displacements for both directions

Both options are compared in terms of the normalized roof displacements (Figure 2.5.2). The normalized roof displacement is the roof displacement at an arbitrary location divided by the roof displacements in the centre of mass (CM). It can be seen that both options yield practically the same results in Y direction, whereas in X direction the option 1 is more conservative. In the following text and results, the first options will be used.

2.5.4 SHEAR FORCES

Shear force at the base of the structure obtained by **modal response spectrum analysis** for X direction amounts to $F_{bX} = 2693$ kN. The corresponding base shear ratio (base shear force versus total weight of the structure above level 0) is equal to $2693 / (2363 \cdot 9.81) = 12\%$. For Y direction, the base shear force and base shear ratio are larger, they amount to $F_{bY} = 3452$ kN and 15%, respectively.

Storey shear forces along the elevation for both directions are shown in Fig. 2.5.3. It can be seen that the storey shear forces in two basement levels are equal to those in level 1, because the masses in basement were neglected in the analysis (see section 2.1.2.3).

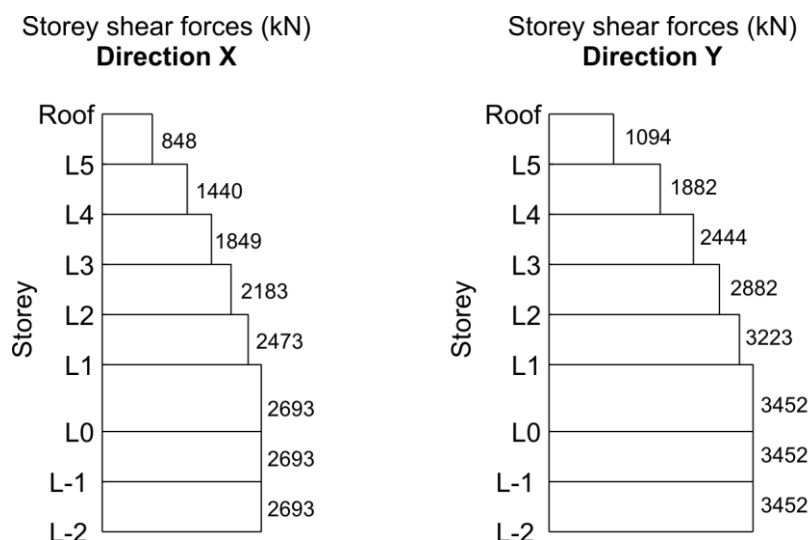

Figure 2.5.3 Storey shear forces along the elevation for two horizontal directions obtained by the modal response spectrum analysis

A quick check of the calculated base shear can be made by comparing it with the upper bound value for the base shear, which can be determined by multiplying the total mass with the design spectral acceleration at the fundamental period in the relevant direction. Considering $M = 2362$ ton and $S_d(T = 0.92 \text{ s}) = 0.14g$ in direction X and $S_d(T = 0.68 \text{ s}) = 0.18g$ in direction Y, the upper bound values for base shear, shown in Table 2.5.3 are obtained. The lower bound values presented in Table 2.5.3 can be obtained in a similar way, but considering the effective mass for the relevant fundamental mode (80.2% and 76.3% of the total mass above the basement in direction X and Y, respectively) instead of the total mass.

Table 2.5.3 Base shear forces

Base shear	Lower bound	Upper bound	Calculated value
Direction X	2602 kN	3244 kN	2693 kN
Direction Y	3182 kN	4171	3452

2.5.5 DISPLACEMENTS

According to EN 1998-1 (Equation 4.23) the actual displacements of a point of the structural system (d_s) shall be calculated as a product of the behaviour factor q and the displacement of the same point

(d_e) obtained by modal response spectrum analysis based on design response spectrum (with included torsional effects). In our case, factor q amounts to 3.0 (see section 2.4). The displacements in the centres of masses (CM) are presented in Table 2.5.4. Both displacements, d_e and d_s , are shown. The ratio of the actual top displacement in the centre of mass and the total height of the building above the basement amounts to $0.118\text{m}/19\text{m} = 0.6\%$ and $0.089/19\text{m} = 0.5\%$ for X and Y directions, respectively.

Table 2.5.4 Displacements in centres of masses along the elevation (d_e and d_s) in both directions

Level	d_e (m)		$d_s = d_e \cdot q$ (m)	
	Direction X	Direction Y	Direction X	Direction Y
ROOF	0.039	0.030	0.118	0.089
5	0.033	0.024	0.100	0.073
4	0.027	0.019	0.080	0.056
3	0.020	0.013	0.060	0.040
2	0.013	0.008	0.039	0.024
1	0.007	0.004	0.020	0.011
0	0.000	0.000	0.001	0.001
-1	0.000	0.000	0.000	0.000

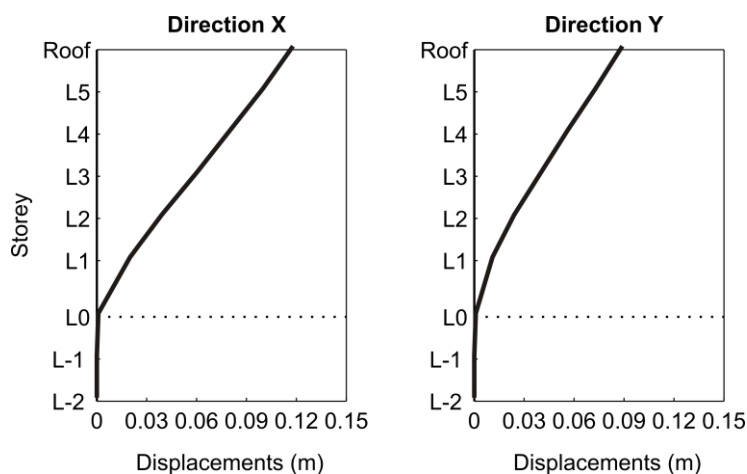

Figure 2.5.4 Actual displacements in centres of masses (d_s) in both directions

2.5.6 DAMAGE LIMITATIONS

The damage limitation requirement should be verified in terms of the interstorey drift (d_r) (EN 1998-1/4.4.3.2) using equation

$$d_r \cdot v \leq \alpha \cdot h \Rightarrow \frac{d_r}{h} \leq \frac{\alpha}{v} \quad (2.7)$$

Storey drift d_r is evaluated as the difference of the average lateral displacements d_s in CM at the top and bottom of the storey (EN 1998-1/4.4.2.2(2)). In EN 1998, it is not defined how the “average” value should be calculated. It seems reasonable to consider the values in CM (see Table 2.5.4) as the

“average” values. Note storey drifts have to be determined for each vibration mode and combined according to a combination rule, e.g. CQC. h is the storey height. ν is the reduction factor which takes into account the lower return period of the seismic action associated with the damage limitation requirement. It depends on the importance class of the building. Test building is classified as importance class II (EN 1998-1/Table 4.3) and the corresponding reduction factor ν amounts to 0.5 (EN 1998-1/4.4.3.2(2)). α is factor which takes into account the type of the non-structural elements and their arrangements into the structure. It amounts to 0.005, 0.0075 and 0.01 (EN 1998-1, equations 4.31, 4.32 and 4.33)

All parameters necessary for the verification of the damage limitation are listed in Table 2.5.6 for both orthogonal directions. It can be seen that the most severe drift limit ($\alpha = 0.005$, for building having non-structural elements of brittle materials attached to the structure) is not exceeded in any storey (see also Figure 2.5.5).

Table 2.5.5 Storey drifts control for both directions

Level	d_r (m) in CM		h (m)	ν	$\nu * d_r / h$		α		
	Dir. X	Dir. Y			Dir. X	Dir. Y	(a)	(b)	(c)
ROOF	0.019	0.016	3	0.5	0.0031	0.0027			
5	0.021	0.017	3	0.5	0.0034	0.0028			
4	0.022	0.017	3	0.5	0.0036	0.0028	0.005	0.0075	0.01
3	0.022	0.016	3	0.5	0.0036	0.0026			
2	0.020	0.013	3	0.5	0.0033	0.0022			
1	0.020	0.010	4	0.5	0.0025	0.0013			

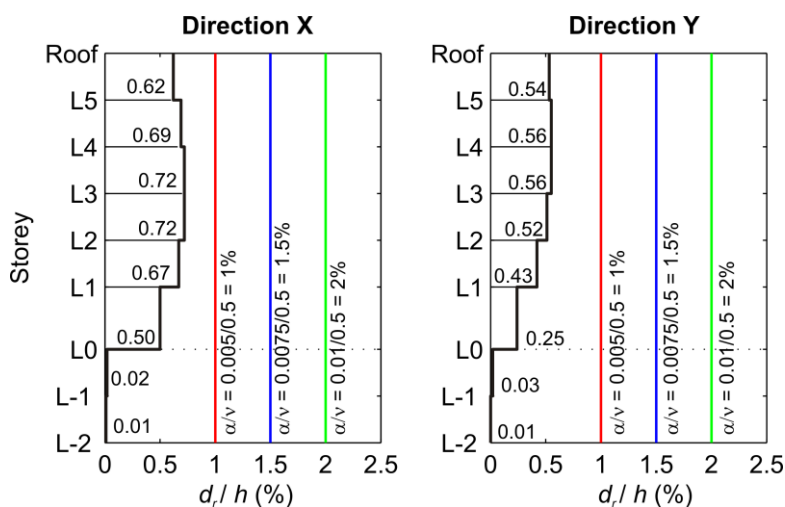

Figure 2.5.5 Storey drifts control for both directions

2.5.7 CRITERION OF THE SECOND ORDER EFFECTS

The criterion for taking into account the second order effect is based on the interstorey drift sensitivity coefficient θ , which is defined with equation (EN 1998-1/4.4.2.2(2))

$$\theta = \frac{P_{tot} \cdot d_r}{V_{tot} \cdot h} \quad (2.8)$$

where d_r is the interstorey drift (see Table 2.5.5), h is the storey height, V_{tot} is the total seismic storey shear obtained by modal response spectrum analysis (Figure 2.5.3) and P_{tot} is the total gravity load at and above the storey considered in the seismic design situation ($G + 0.3Q$, see section 2.5.6). The sensitivity coefficients along the elevation for both directions are determined in Table 2.5.6.

In the case of the investigated building, the second order effects need not be taken into account, because the interstorey drift sensitivity coefficient θ is smaller than 0.1 in all storeys in both directions (see Figure 2.5.6).

Table 2.5.6 Determination the interstorey drift sensitivity coefficient θ

Level	P_{tot} (kN)	h (m)	V_{tot} (kN)		d_r (m) in CM		θ	
			Dir. X	Dir. Y	Dir. X	Dir. Y	Dir. X	Dir. Y
ROOF	3650	3	848	1094	0.019	0.016	0.03	0.02
5	7659	3	1440	1882	0.021	0.017	0.04	0.02
4	11669	3	1849	2444	0.022	0.017	0.05	0.03
3	15678	3	2183	2882	0.022	0.016	0.05	0.03
2	19688	3	2473	3223	0.020	0.013	0.05	0.03
1	23817	4	2693	3452	0.020	0.010	0.04	0.02

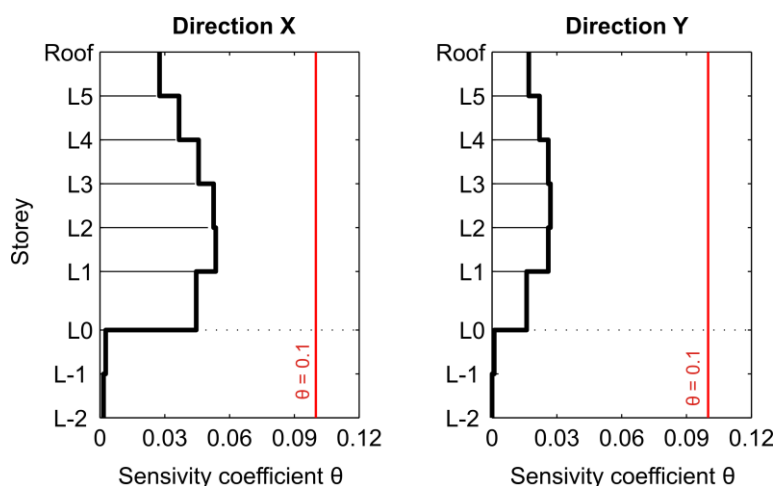

Figure 2.5.6 Sensitivity coefficient θ for both directions

2.5.8 SEISMIC DESIGN SITUATION

For the determination of the design value of the action effects (e.g. internal forces) the load combination of gravity and seismic loads has to be taken into account due to the seismic design situation (EN 1990/6.4.3.4)

$$1.0 \cdot G + \psi_{2i} \cdot Q \pm E_{XY} (\pm M_a) \quad (2.9)$$

where G represents permanent gravity loads (self weight and additional dead loads), Q is live load (variable, imposed load), which is reduced with factor $\psi_{2i} = 0.3$ (EN 1990/Table A.1.1, office building), and E_{XY} is the combined seismic action for both directions obtained by modal response spectrum analysis with included torsional effects ($\pm M_a$, see section 2.5.3).

2.5.9 INTERNAL FORCES

The shear forces and bending moments obtained by the modal response spectrum analysis (RSA) are presented in the following figures. The results are shown for selected frames and walls.

Note that the signs in results obtained by RSA have been lost due to the combinations. The correct signs can be seen in the results of static analysis (Section 2.6.4).

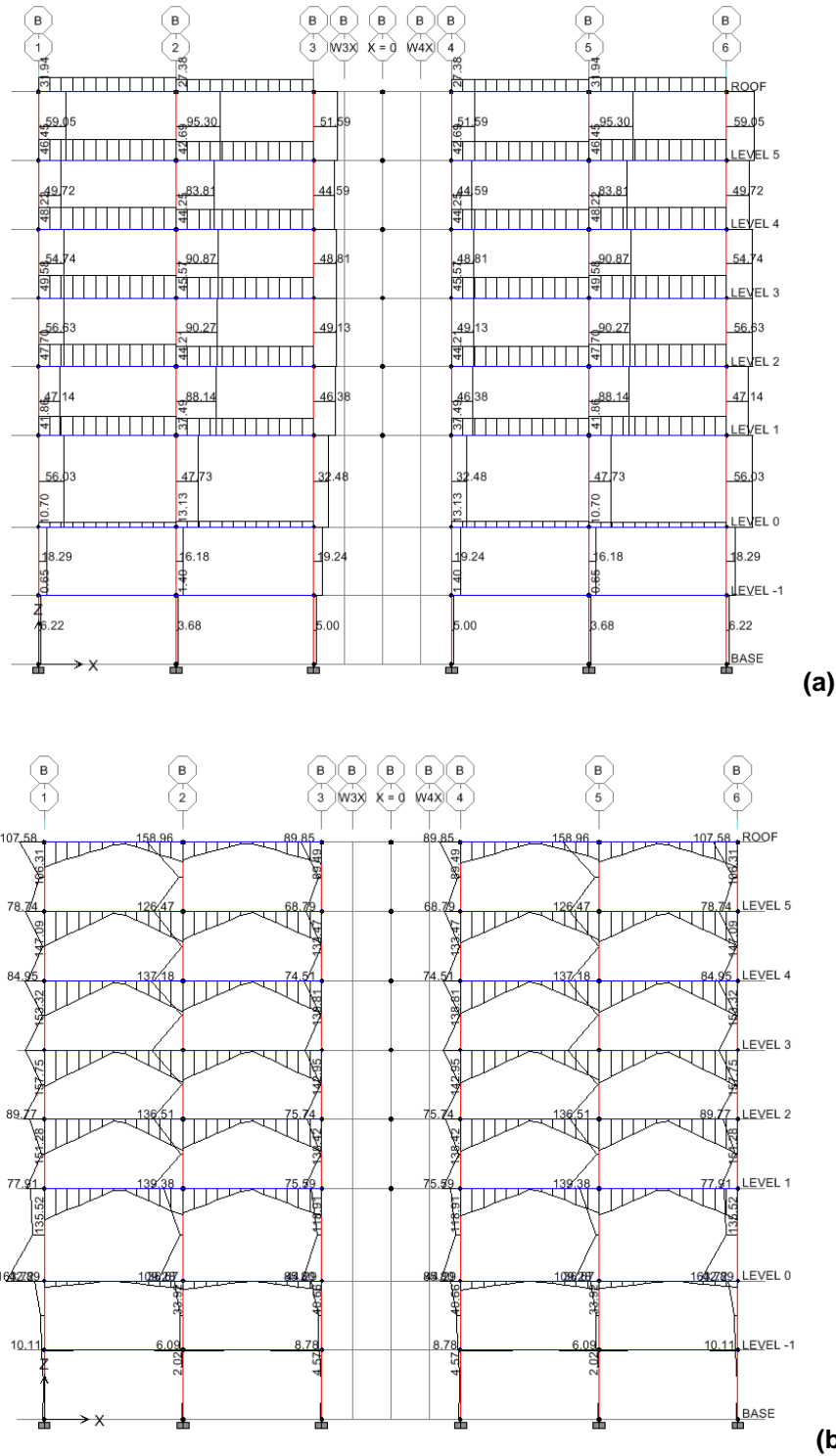

Figure 2.5.7 Shear forces (a) and bending moments (b) for internal frame B (see Figs. 2.1.1 and 2.1.2) in X direction obtained by modal response spectrum analysis.

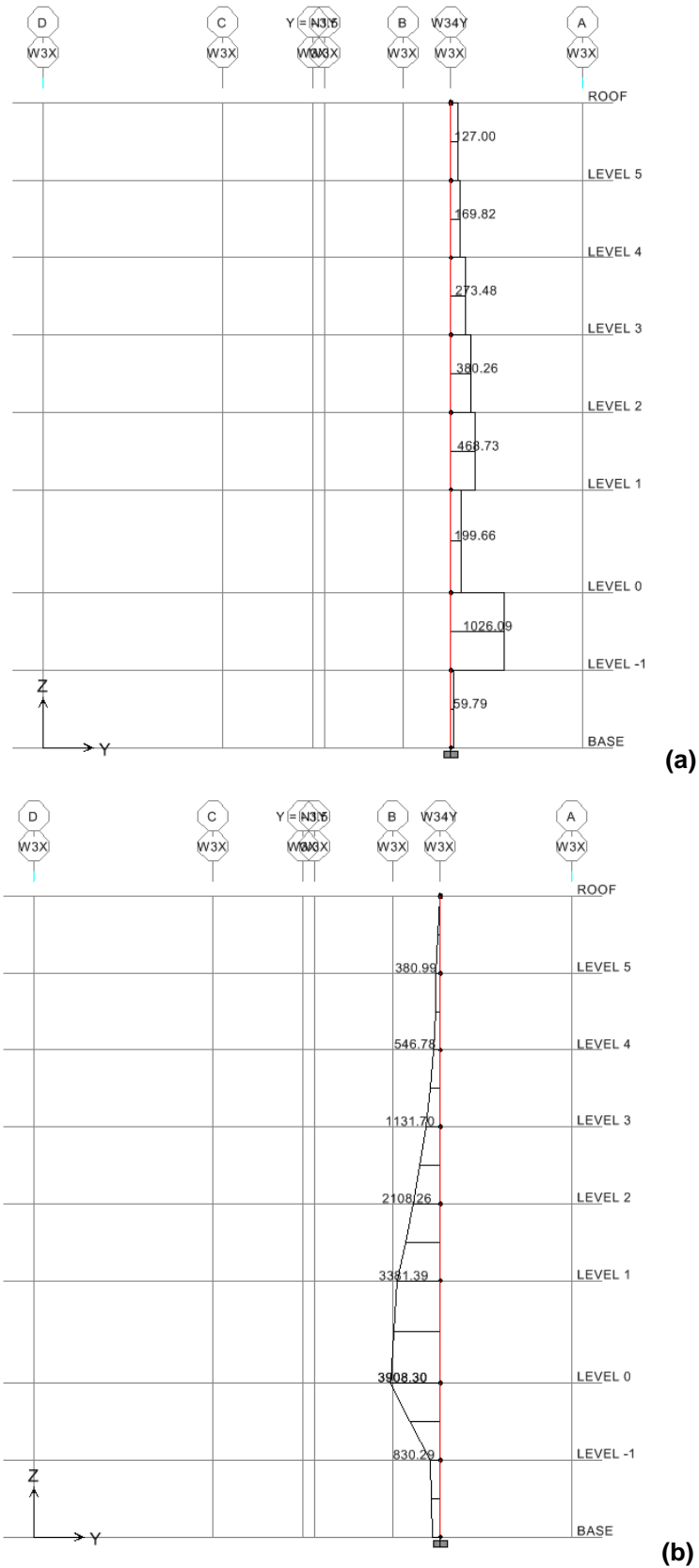

Figure 2.5.9 Shear forces (a) and bending moments (b) for wall W3 (see Figs. 2.1.1 and 2.1.2) in Y direction obtained by modal response spectrum analysis.

2.6 Lateral force method of analysis

2.6.1 GENERAL

In the case of the investigated structure, the lateral force method is allowed, because both requirements in EN 1998-1/4.3.3.2.1 are satisfied. The structure is categorized as being regular in elevation (Section 2.3) and the fundamental mode periods in both directions ($T_X = 0.92$ s and $T_Y = 0.68$ s) are smaller than the minimum of the 2 s and $4T_c$, where T_c amounts to 0.5 s (see section 2.5.2). Nevertheless, the test structure presented in this report was analysed by modal response spectrum analysis (Section 2.5), which is the reference method in Eurocode 8 and is considered as more accurate than the lateral force method. In addition, for comparison and for obtaining information about the signs of internal forces (which are lost in the case of the modal response spectrum analysis), the lateral force method has also been applied. The same (spatial) structural model was used as in the case of the modal response spectrum analysis presented in section 2.5.

2.6.2 THE FUNDAMENTAL PERIOD OF VIBRATION T_1 USING RAYLEIGH METHOD

The fundamental mode period T_1 for each horizontal directions can be calculated according to the Rayleigh method by equation

$$T_1 = 2\pi \sqrt{\frac{\sum_{i=1}^n (m_i \cdot s_i^2)}{\sum_{i=1}^n (f_i \cdot s_i)}} \quad (2.10)$$

where $n = 6$ is the number of storeys above the top of the rigid basement (above the Level 0), m_i are storey masses (only masses above the top of the rigid basement are considered), f_i are horizontal forces (triangular shape was used) acting on storey i in centres of storey masses and s_i are displacements of masses caused by horizontal forces f_i . Storey masses m_i , horizontal forces f_i and displacements s_i are listed in Table 2.6.1.

Table 2.6.1 Quantities (horizontal forces f_i , displacements s_i and storey masses m_i) needed for the determination of the fundamental period using Rayleigh method

Level	$f_{iX} = f_{iY}$ (kN)	s_{iX} (m)	s_{iY} (m)	m_i (ton)
ROOF	1900	0.1051	0.0599	372
5	1600	0.0891	0.0491	396
4	1300	0.0715	0.0380	396
3	1000	0.0530	0.0268	396
2	700	0.0346	0.0164	396
1	400	0.0175	0.0076	408

Fundamental periods amount to $T_1 = 0.91$ s and 0.72 s for direction X and Y, respectively. Note an excellent agreement with more accurate results (Section 2.5.2).

2.6.3 BASE SHEAR FORCE AND DISTRIBUTION OF THE HORIZONTAL FORCES ALONG THE ELEVATION

The seismic base shear force F_b for each horizontal direction was determined by expression (EN 1998-1/4.5)

$$F_b = S_d(T_1) \cdot m \cdot \lambda \quad (2.11)$$

where m is the total mass above the top of the basement ($m = 2362$ ton), T_1 is the fundamental period in X or Y direction ($T_{1,X} = 0.92$ s and $T_{1,Y} = 0.68$ s, Section 2.5.2), $S_d(T_1)$ is the ordinate of the design spectrum at the period T_1 ($S_d(T_{1,X} = 0.92) = 0.14g$ and $S_d(T_{1,Y} = 0.68) = 0.18g$), and factor λ is 0.85 (building has more than two stories and $T_1 \leq 2T_C$ in both directions; $T_C = 0.5$ s).

The base shear force amounts to $F_{b,X} = 2676$ kN (12% of the total weight without basement) in direction X and $F_{b,Y} = 3621$ kN (16% of the total weight without basement) in direction Y.

The horizontal force in i -th storey F_i was determined using equation (EN 1998-1/4.11)

$$F_i = F_b \cdot \frac{z_i \cdot m_i}{\sum z_j \cdot m_j} \quad (2.12)$$

where m_i (m_j) are the storey masses and z_i (z_j) are the heights of the masses above the basement level (above level 0). Results are presented in Table 2.6.2.

Table 2.6.2 Determination of the horizontal forces (F_{iX} and F_{iY}) for both horizontal directions

Level	z_i (m)	m_i (ton)	$m_i \cdot z_i$	F_{iX} (kN)	F_{iY} (kN)
ROOF	19	372	7063	703	951
5	16	396	6329	630	852
4	13	396	5142	512	692
3	10	396	3956	394	533
2	7	396	2769	276	373
1	4	408	1631	162	220
Σ =			26890	2676	3621

2.6.4 DISTRIBUTION OF THE HORIZONTAL FORCES TO INDIVIDUAL FRAMES AND WALLS AND SHEAR FORCES

Force distributions and shear forces for both directions are shown in Figs. 2.6.1 and 2.6.2. The results are shown for the selected frames and walls for both directions of the horizontal forces. It can be clearly seen that the distributions are quite irregular because the structure consists of individual elements (frames and walls) which are characterized by different deformation shapes. The major irregularity occurs at the ground level (Level 0), where the loads are transferred to the very stiff peripheral elements. Note that the irregularities would be slightly reduced if the deformability of the slab was taken into account. Note also, that the transfer of loads is associated with high shears in the slab which should be checked (not shown in this report). In order to determine these shear forces the correct signs of the forces in frames and walls are needed. They are provided by the lateral force

analysis, whereas they are lost when using the combination rules in modal response spectrum analysis.

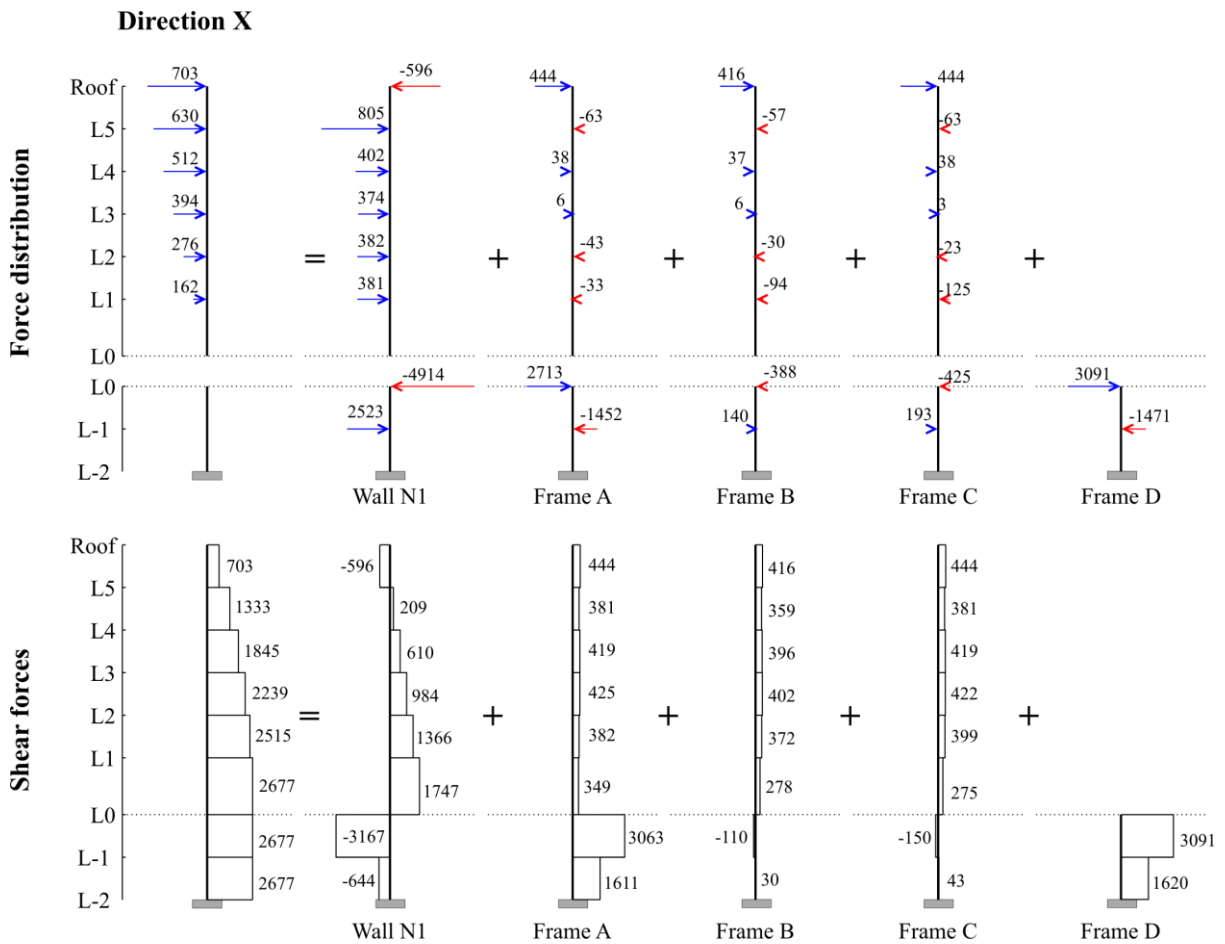

Figure 2.6.1 Distribution of the horizontal forces and shear forces to individual frames and walls in X direction

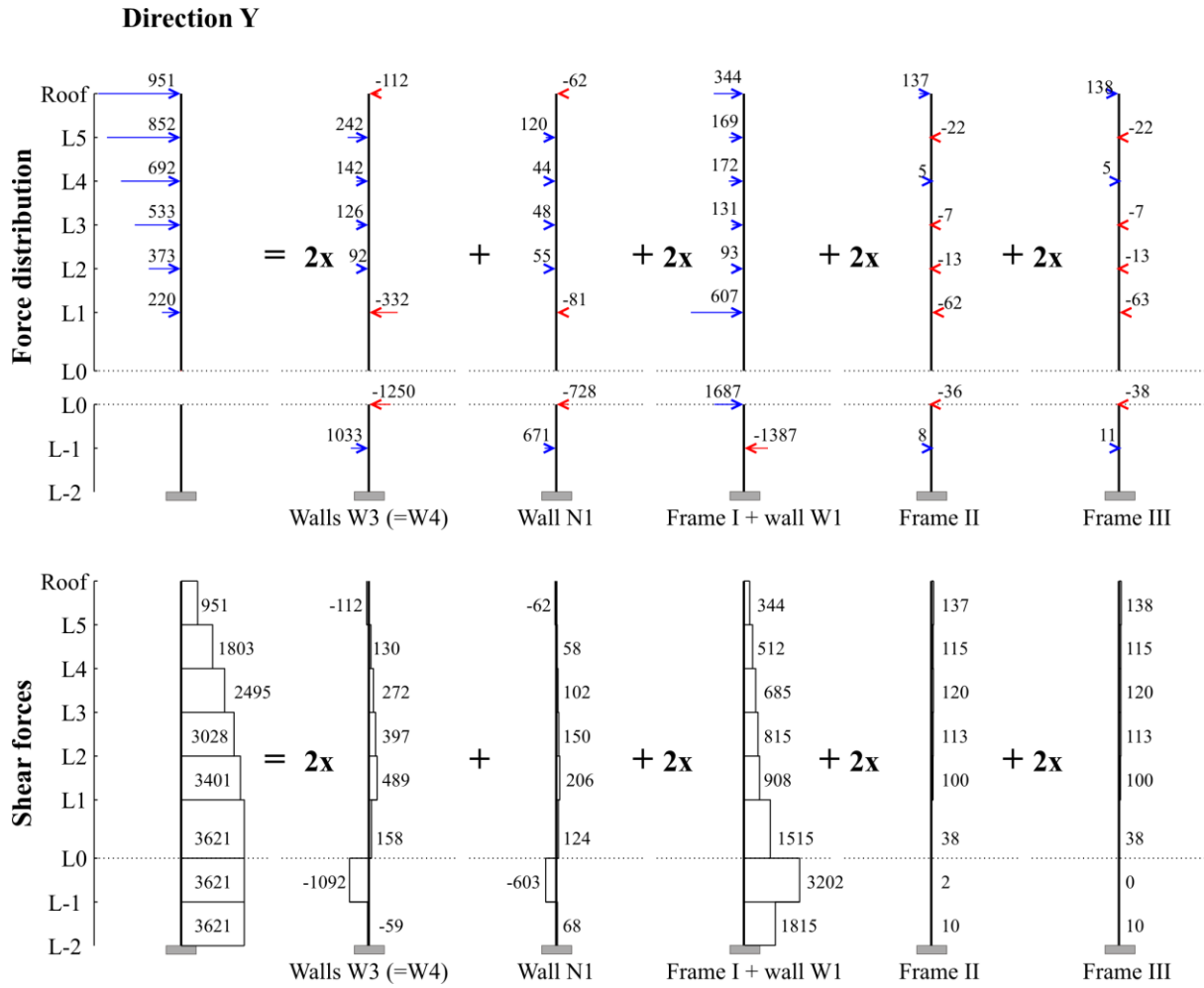

Figure 2.6.2 Distribution of the horizontal forces and shear forces to individual frames and walls in Y direction

CHAPTER 3

Specific rules for design and detailing of concrete building. Design for DCM and DCH. Illustration of elements design

M.N Fardis and G. Tsionis

University of Patras

3.1 Introduction and overview

This Chapter of the report focuses on the rules of EN 1998-1:2004 for the design and detailing of concrete buildings for ductility and on the procedure to be followed to achieve the goal of EN-Eurocode 8. This is done through the application of EN-Eurocode 8 to the design of the example building for earthquake resistance. Needless to say, the building is also designed and detailed to meet the rules and requirements of EN-Eurocode 2.

Before going into the detailed design of all elements of the example building, from the roof to the foundation soil, the Chapter gives first an overview of:

- a) the process for detailed seismic design of concrete buildings, as this is dictated by the interdependencies of design phases according to EN-Eurocode 8 (mainly owing to capacity design) and
- b) the design and detailing rules in EN-Eurocode 8 for beams, columns and ductile walls of the three Ductility Classes (DC) in EN-Eurocode 8 (DC Low, Medium or High).

The detailed design of all elements of the example building is done “automatically”, through computational modules having as built-in the dimensioning and detailing rules of Eurocodes 2 and 8. The modules are activated in a prescribed sequence, such that all outcomes which are necessary as input to subsequent design phases of the same or other elements or types of elements are archived for future use. Examples of such information include:

- a) the moment resistances at the end sections of beams for the capacity design of the columns they frame into;
- b) the moment resistances at the ends of beams and columns for the capacity design in shear of these elements and of the ones they frame into;
- c) the cracked stiffness of beams that restrain columns against buckling;
- d) the capacity design magnification factors at the base of columns or walls for the design of their footings, etc.

The design is on purpose “minimalistic”: the reinforcement is tailored to the demands of the analysis and of EN-Eurocodes 2 and 8, to avoid overstrengths and margins that are not absolutely needed and would have reflected the choice of the designer rather than the Eurocodes’ intention.

3.2 Material properties

- o Concrete C25/30 and steel S500 of Class C are used;
- o Exposure class per Eurocode 2 is XC3, for which the nominal concrete cover of the reinforcement is 35 mm.
- o The soil is clay with design value of undrained shear strength $c_{ud} = 300$ kPa (reduced by 10% to $c_{ud} = 270$ kPa for the seismic design situation), design value of friction angle $\delta_d = 20^\circ$ and design value of drained cohesion $c_d = 50$ kPa; these properties are consistent with its characterisation as Ground type B for the purposes of the definition of the seismic action at the top of the ground.

3.3 Geometry of foundation elements

Figures 3.3.1 and 3.3.2 depict the layout of the foundation in plan and a vertical section of the building showing the foundation elements. Single footings with dimensions 2.0×2.0×0.8 (width×depth×height in meters) are used for columns C7 and C10, 1.8×1.8×0.8 for columns C8 and C9 and 2.0×1.5×0.8 for columns C12 to C15. A common footing with dimensions 4.0×5.0×1.0 is used for the two walls W3, W4 and an individual footing with dimensions 4.5×2.5×0.8 for wall W5. A strip footing with width 1.0 m and height 0.30 m is used for the perimeter walls. Instead of a system of two-way tie-beams, horizontal connection of the footings and the foundation strip of the basement perimeter walls is provided by a foundation slab cast right below the top of the footings and the perimeter foundation strip (see clause 5.4.1.2 para. (2), (3) and (7) of EN 1998-5:2004). This slab serves also as a floor of the lower basement and helps create a rigid-box foundation system together with the perimeter walls and the slab at the roof of the upper basement.

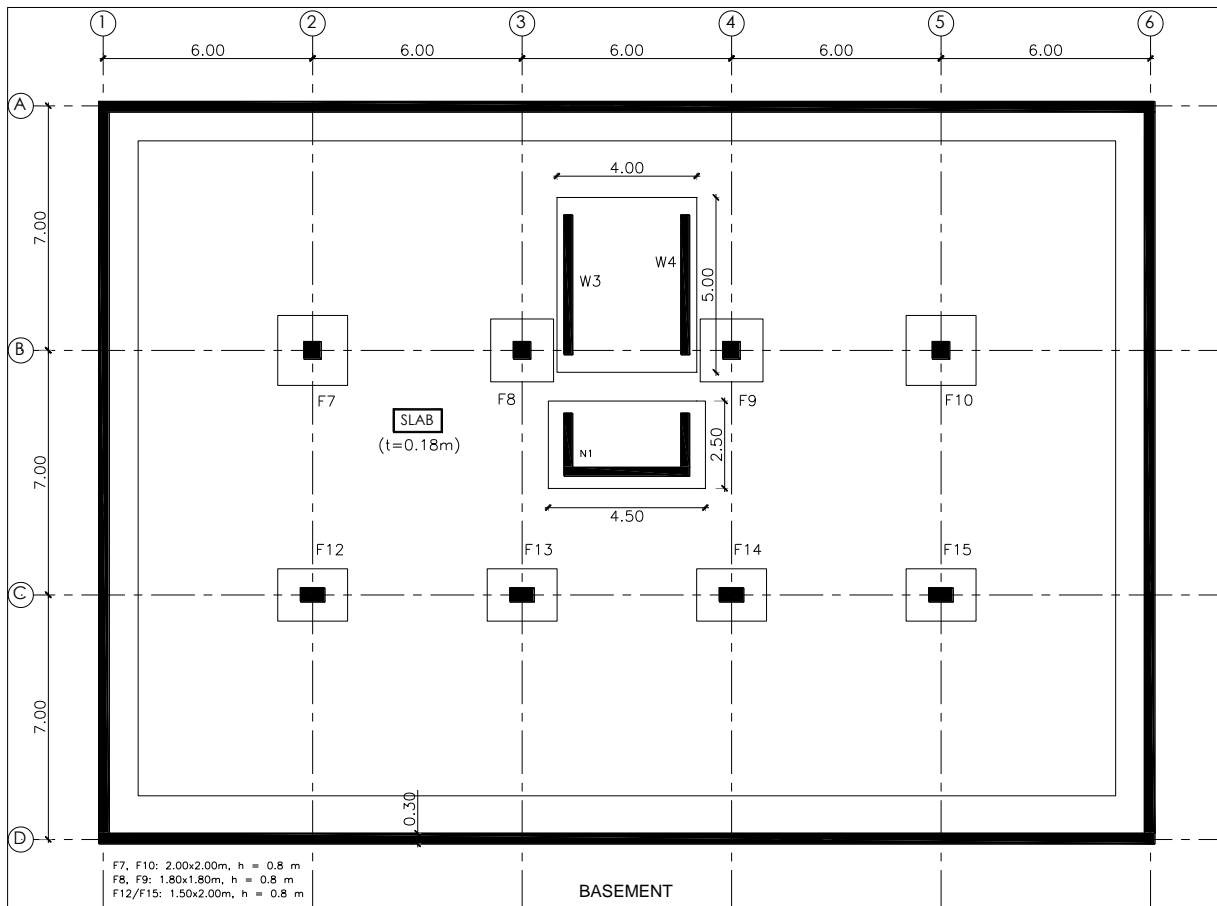

Fig. 3.3.1 Plan of the foundation

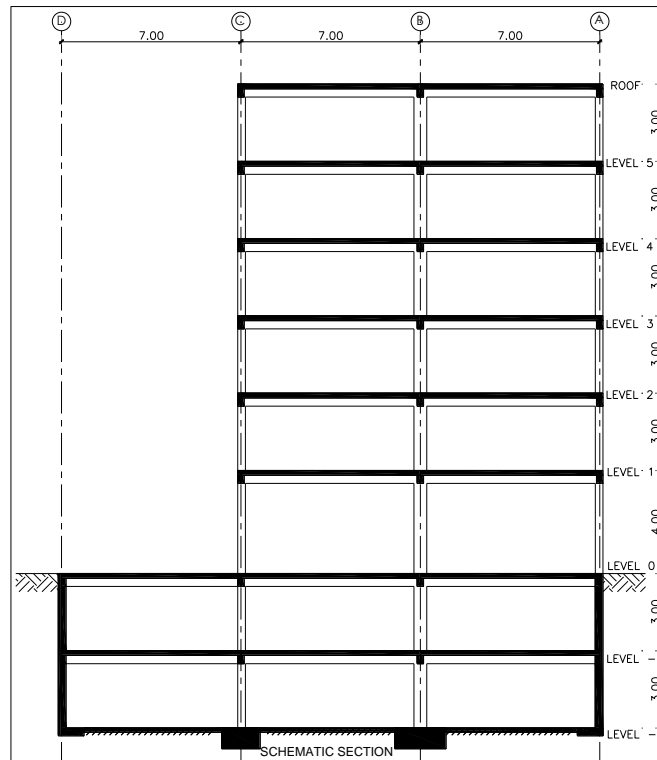

Fig. 3.3.2 Section in the Y direction showing the foundation elements

3.4 ULS and SLS verifications and detailing according to Eurocodes 8 and 2

3.4.1 GENERAL

Clause 4.4.2.1(1) of Eurocode 8 prescribes the conditions regarding resistance, ductility, equilibrium and foundation stability that should be met at the ultimate limit state. To satisfy the resistance condition, it is verified that for all structural elements and all critical regions $E_d \leq R_d$, where E_d is the design value of the action effect due to the seismic design situation and R_d is the corresponding design resistance of the element. In the resistance calculations, clause 5.2.4(2) recommends the use of the partial factors for material properties applicable for the persistent and transient design situations. According to clause 2.4.2.4(1) of Eurocode 2, their recommended values are $\gamma_c = 1.5$ for concrete and $\gamma_s = 1.15$ for reinforcing steel.

3.4.2 OVERVIEW OF THE DETAILED DESIGN PROCEDURE

Especially in frames, capacity design introduces strong interdependence between various phases of a building's detailed seismic design for ductility, within or between members:

- o dimensioning a column in flexure depends on the amount and layout of the longitudinal reinforcement of the beams it is connected to in any horizontal direction;
- o dimensioning of a column or a beam in shear depends on the amount and detailing of its own longitudinal reinforcement, as well as of those framing into them at either end;

- o verification of the foundation soil and design of foundation elements (especially of individual footings and their tie-beams) depends on the amount and layout of the longitudinal reinforcement of the vertical elements they support, etc.
- o dimensioning any storey of a shear wall in shear depends on the amount and detailing of vertical reinforcement at the base of the bottom storey; etc.

The detailed design operations should follow a certain sequence, so that information necessary at a step is already available. More important, if detailed design takes place within an integrated computational environment (as is not only common, but also essential nowadays), this information should be appropriately transferred between the various modules of the system.

Flow Charts 3.4.1 and 3.4.2 depict the interdependence of the various components of a detailed design process and suggests. A sequence is suggested there (with roman numerals) for their execution, with specific reference to equations, sections or tables in this or previous chapters. Step IVa in Flow Chart 3.4.1 may be carried out before IVb or vice-versa; while Steps V to VII can be executed at any sequence after II and III, even before IVa and IVb. The same applies to Step IV in Flow Chart 3.4.2, with respect to II and III there.

Flow Chart 3.4.1 Steps and interdependencies in dimensioning and detailing frame members in DC M or DC H

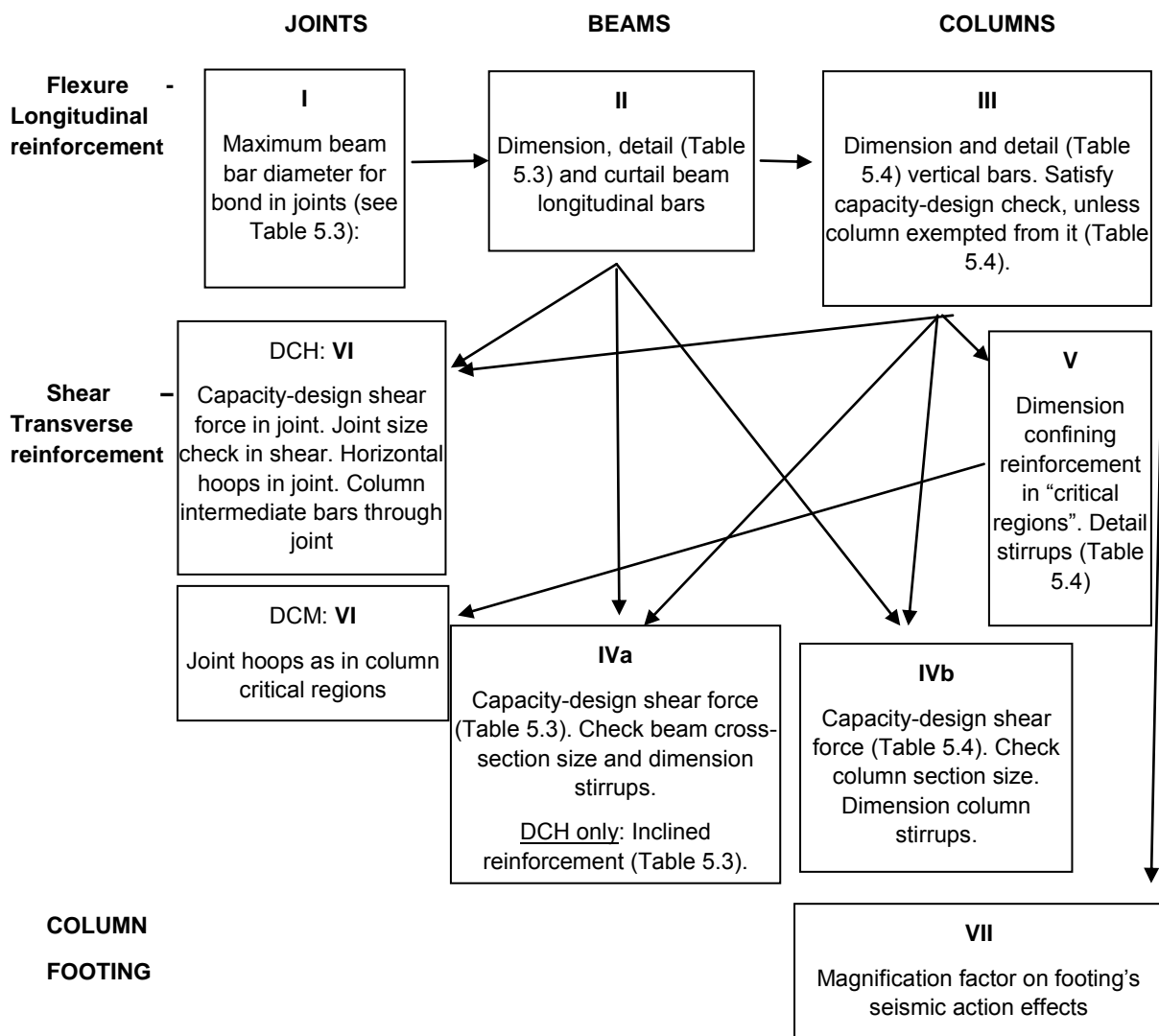

Flow Chart 3.4.2 : Steps and interdependencies in dimensioning and detailing slender ductile walls of DC M or DC H

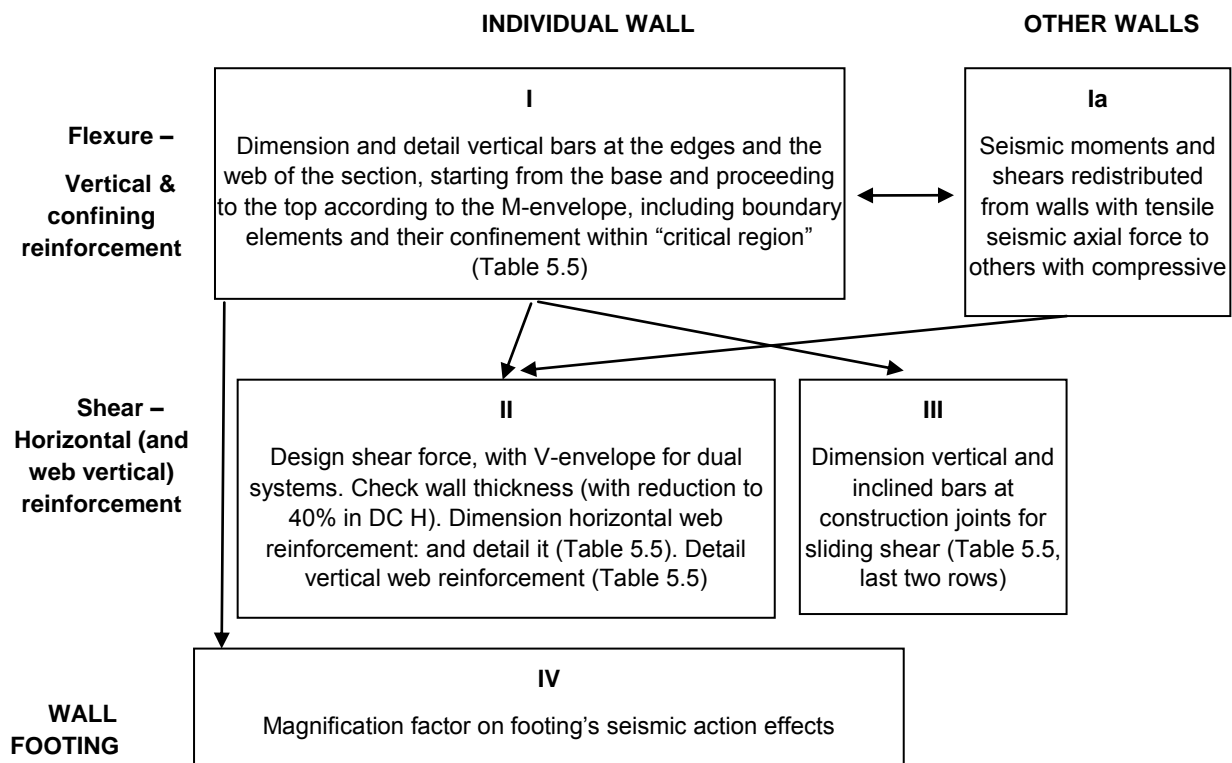

The procedure for the design of the complete example building follows the steps below:

1. The beams are fully designed for:
 - o the ULS in bending under the persistent and transient design situation and the seismic design situation (whichever governs at each beam section) and
 - o the SLS of stress limitation in concrete and steel and crack width limitation under the frequent and the quasi-permanent combination of actions, whichever applies.

The maximum beam bar diameter that can pass through or terminate at beam-column joints is determined at each one of them; the shear stresses that develop in the joint core due to the beam bars passing or terminating there is calculated as well. The beam design is carried out for one multi-storey plane frame at a time, possibly with different number of bays in different storeys. Foundation beams are designed in bending in the same way and with the same computational module, but specifying them as one-storey elements and not as the beams at the lowest level of a multistorey plane frame. Archived are:

- o the design values of beam moment resistances around joints, to be used in Step 2 for the capacity design of columns and Step 3 for the capacity design of beams in shear;
- o the beam longitudinal bar diameters, for use in Step 3 to determine the maximum stirrup spacing to prevent buckling of these bars;
- o the cracked stiffness of beams around joints, taking into account their reinforcement and concrete cracking, for use in Step 2 to calculate the effective buckling length of the columns connected to these beams.

2. The columns are fully designed in bending and in shear, after checking that their cross-section meets Eurocode 2's slenderness limits for negligible second-order effects in braced or unbraced conditions – whichever applies - under the persistent and transient design situation. This step is carried out for one multi-storey column at a time (from the roof to the foundation), using the moment resistance of the beams framing into the columns' joints, as calculated and archived in Step 1. Archived are:
 - o the design values of column moment resistances around joints under the maximum and the minimum axial loads encountered in the seismic design situation according to the analysis, for use in Step 3 for the capacity design of beams in shear;
 - o the capacity design magnification factors at the connection of the column to the foundation, for use in Step 5 for the capacity design of the ground and the foundation elements; they are calculated separately and archived for the different directions and sense of action of the design earthquake, which produce 8 combinations of signs of the column's seismic biaxial moments and axial force.
3. The beams and their transverse reinforcement are fully designed in shear (per multi-storey frame, possibly with different number of spans in every storey), using for the capacity design the moment resistances of columns and beams calculated and archived in Steps 1 and 2 and for the maximum stirrup spacing the beam longitudinal bar diameters from Step 1. As in Step 1, the beams' shear design is carried out for one multi-storey plane frame at a time, possibly with different number of bays in different storeys. Foundation beams are designed in shear in the same way and with the same computational module, but specifying them as one-storey elements and not as the beams at the lowest level of a multistorey plane frame.
4. The walls are fully designed in bending and shear. The step is carried out for one multi-storey wall at a time (from the roof to the foundation). As for columns in Step 2, archived are:
 - o the capacity design magnification factors at the connection of the wall to the foundation (separately for the 8 combinations of signs of the wall's seismic biaxial moments and axial force), for use in Step 5 for the capacity design of the ground and the foundation elements.
5. The bearing capacity of the ground is calculated under each footing for biaxial eccentricity of the vertical load and bidirectional horizontal forces (bidirectional inclination of the vertical load) and checked against the soil pressure at the underside of the footing. Seismic reaction forces and moments at the node connecting the footing to the ground are amplified by the corresponding capacity design magnification factor at the connection of the vertical element to the footing (a different value for the different directions and sense of action of the design earthquake). The footing itself and its reinforcement are then dimensioned in shear, in doubly-eccentric punching shear and in flexure for all directions and sense of action of the design earthquake, as well as for the persistent and transient design situation (Eqs. (6.10a), (6.10b) in EN 1990:2002). This step is carried out separately for each individual footing.
6. The strip footings of the foundation beams are then designed, in a one-way version of the design of individual footings in Step 5. The step is carried out for the full length of the strip footings of each foundation beam, that may encompass quite a few intermediate nodes and vertical soil springs.

3.4.3 ADDITIONAL INFORMATION FOR THE DESIGN OF BEAMS IN BENDING

According to clause 5.4.2.1(1) of Eurocode 8, the design values of bending moments are obtained from the analysis of the structure for the seismic design situation. The bending resistance is calculated in accordance with Eurocode 2, as prescribed in 5.4.3.1.1(1) of Eurocode 8, taking into account the detailing requirements in section 5.4.3.1.2. Following 5.8.1(5) of Eurocode 8, the beams within the

rigid-box basement (including those at the basement roof) are expected to remain elastic under the seismic design situation and are designed for Low Ductility Class (DC L).

An overview of the design and detailing requirements applied to the design of the beams, not only for the DCs applied in the present example, but also for DC H (High), is given in Table 3.4.3.

3.4.4 ADDITIONAL INFORMATION FOR THE DESIGN OF COLUMNS

According to clause 5.4.2.1(1) of Eurocode 8, the design values of bending moments and axial forces are obtained from the analysis of the structure for the seismic design situation. Capacity design requirements for columns in bending at beam/column joints do not apply in the present example, as the building is classified as wall and wall-equivalent structural system.

According to clause 5.4.2.3(1) of Eurocode 8, the design values of shear forces are determined in accordance with the capacity design rule, on the basis of the equilibrium of the column under end moments that correspond to the formation of plastic hinges at the ends of the beams connected to the joints into which the column end frames, or at the ends of the columns (wherever they form first). In 5.4.2.3(1) the end moments are defined as $M_{i,d} = \gamma_{Rd} M_{Rc,i} \min(1, \sum M_{Rc} / \sum M_{Rb})$, where γ_{Rd} is a factor accounting for overstrength due to steel strain hardening and confinement of the concrete of the compression zone of the section, $M_{Rc,i}$ is the design value of the column moment of resistance at end i , $\sum M_{Rc}$ and $\sum M_{Rb}$ are the sum of the design values of the moments of resistance of the columns and the sum of the design values of the moments of resistance of the beams framing into the joint, respectively ($\gamma_{Rd} = 1.1$ for DC M and $\gamma_{Rd} = 1.3$ for DC H).

The bending and shear resistance are calculated in accordance with Eurocode 2, as prescribed in clause 5.4.3.2.1(1) of Eurocode 8, using the value of the axial force from the analysis in the seismic design situation and taking into account the detailing requirements in section 5.4.3.2.2.

Following clause 5.8.1(5) of Eurocode 8, the columns within the rigid-box basement are expected to remain elastic under the seismic design situation and are designed for Low Ductility Class (DC L).

An overview of the design and detailing requirements applied to the design of columns, not only for the DCs applied in the present example, but also for DC H, is given in Table 3.4.4.

3.4.5 ADDITIONAL INFORMATION FOR THE DESIGN OF BEAMS IN SHEAR

According to clause 5.4.2.2(1) of Eurocode 8, the design values of shear forces are determined in accordance with the capacity design rule, on the basis of the equilibrium of the beam under the transverse load acting on it in the seismic design situation and end moments that correspond to the formation of plastic hinges at the ends of the beam or at the columns connected to the joints into which the beam end frames (wherever they form first). In 5.4.2.2(2) the end moments are defined as $M_{i,d} = \gamma_{Rd} M_{Rb,i} \min(1, \sum M_{Rc} / \sum M_{Rb})$, where γ_{Rd} is a factor accounting for overstrength due to steel strain hardening and confinement of the concrete of the compression zone of the section and is equal to $\gamma_{Rd} = 1.0$ for DCM or $\gamma_{Rd} = 1.2$ for DCH, $M_{Rb,i}$ is the design value of the beam moment of resistance at end i , $\sum M_{Rc}$ and $\sum M_{Rb}$ are the sum of the design values of the moments of resistance of the columns and the sum of the design values of the moments of resistance of the beams framing into the joint, respectively.

The bending and shear resistance are calculated in accordance with Eurocode 2, as prescribed in clause 5.4.3.1.1(1), taking into account the detailing requirements in section 5.4.3.1.2.

Following 5.8.1(5), the beams within the rigid-box basement (including those at the basement roof) are expected to remain elastic in the seismic design situation and are designed for DC Low.

3.4.6 ADDITIONAL INFORMATION FOR THE DESIGN OF DUCTILE WALLS

To account for uncertainties regarding the moment distribution along the height of slender walls, i.e. walls with height to length ratio $h_w / l_w > 2.0$, clause 5.4.2.4(5) of Eurocode 8 specifies that the design bending moment diagram along the height of the wall is given by an envelope of the bending moment diagram from the analysis, vertically displaced by h_{cr} . The height of the critical region above the top of the rigid-box foundation is defined in 5.4.3.4.2(1) of Eurocode 8 as $h_{cr} = \max [l_w, h_w / 6]$. The critical height must be less than $2l_w$ and also, for buildings with up to six storeys, less than the clear storey height, h_s . A linear envelope is allowed, as the structure does not exhibit discontinuity in mass, stiffness or resistance along its height.

According to 5.8.1(5) of Eurocode 8, shear walls in box-type basements are designed for development of a plastic hinge at the base of the roof slab and the critical region extends below the basement roof level up to a depth of h_{cr} .

To account for the possible increase in shear forces after yielding at the base, clause 5.4.2.4(7) of Eurocode 8 specifies that the design shear forces of DC M walls are taken as being 50% higher than the shear forces obtained from the analysis. Moreover and according to 5.8.1(5) of Eurocode 8, the walls within the basement are dimensioned in shear assuming that they develop their flexural overstrength $\gamma_{Rd} M_{Rd}$ at the basement roof level and zero moment at the foundation level.

The bending and shear resistance are calculated in accordance with Eurocode 2, as prescribed in clause 5.4.3.4.1(1) of Eurocode 8, taking into account the detailing requirements in section 5.4.3.4.2.

An overview of the design and detailing requirements applied to the design of the walls for DC L (Low), M (Medium) and H (High), is given in Table 3.4.5.

3.4.7 ADDITIONAL INFORMATION FOR THE DESIGN OF FOUNDATION BEAMS

The perimeter walls of the basement may be treated as deep beams, i.e. beams with span-to-depth ratio less than 3 according to the definition of clause 5.3.1(3) of Eurocode 2. The design values of bending moments and shear forces can be obtained from the analysis for the seismic design situation, multiplied by the capacity design factor $\gamma_{Rd} \Omega = 1.4$ specified in clause 4.4.2.6(4), (5) and (8) of Eurocode 8 for foundation elements serving more than one vertical element (in the present case, all vertical elements on the side of the perimeter in question). Owing to the application of this capacity design factor $a_{CD} = 1.4$, the bending and shear resistance may then be calculated in accordance with Eurocode 2, taking into account the detailing requirements for deep beams in section 9.7 of Eurocode 2.

The present model of the example building does not include vertical (Winkler) springs to reflect the compliance of the soil. Instead, the nodes of the deep beams modelling the perimeter walls of the basement were fully constrained vertically. As a consequence, the analysis produced essentially nil moments and shears for the deep foundation beams. So, the design and detailing of these beams are not included in the example.

3.4.8 ADDITIONAL INFORMATION FOR THE DESIGN OF FOOTINGS

The design action effects for the foundation elements are derived on the basis of capacity design. According to clause 4.4.2.6(4) of Eurocode 8, action effects are calculated as $E_{Fd} = E_{F,G} + \gamma_{Rd} \Omega E_{F,E}$, where $E_{F,G}$ is the action effect due to the combination $\sum G_{k,j}$ "+" $\sum \psi_{2,i} Q_{k,i}$, γ_{Rd} is an overstrength factor equal to 1.0 for $q = 3$ (as in the present case) and to 1.2 for $q > 3$ and $E_{F,E}$ is the action effect from the analysis for the design seismic action. According to 4.4.2.6(5) of Eurocode 8, for columns $\Omega \leq q$ is the

ratio of the design bending resistance, M_{Rd} , to the design bending moment, M_{Ed} , for the seismic design situation, both taken at the cross-section above the footing. For common footings of more than one vertical elements, clause 4.4.2.6(8) allows the use of the values $\Omega = 1$ and $\gamma_{Rd} = 1.4$ instead of more detailed calculations.

Clause 5.8.1(1) of Eurocode 8 requires the design of the foundation elements to follow the relevant rules of Eurocode 8 – Part 5. As capacity design requirements are met, according to 5.8.1(2), no energy dissipation is expected in the foundation elements for the seismic design situation and therefore the rules for Low Ductility Class apply.

Table 3.4.3 EN 1998 rules for detailing and dimensioning of primary beams (secondary beams as in DCL)

	DC H	DCM	DCL
“critical region” length	$1.5h_w$	h_w	
<i>Longitudinal bars (L):</i>			
ρ_{min} , tension side	$0.5f_{ctm}/f_{yk}$		$0.26f_{ctm}/f_{yk}$, $0.13\%^{(0)}$
ρ_{max} , critical regions ⁽¹⁾	$\rho' + 0.0018f_{cd}/(\mu_\phi \epsilon_{sy,d} f_{yd})^{(1)}$		0.04
$A_{s,min}$, top & bottom	$2\Phi 14$ (308mm ²)	-	
$A_{s,min}$, top-span	$A_{s,top-supports}/4$	-	
$A_{s,min}$, critical regions bottom	$0.5A_{s,top}^{(2)}$		-
$A_{s,min}$, supports bottom	$A_{s,bottom-span}/4^{(0)}$		
d_{bL}/h_c - bar crossing interior joint ⁽³⁾	$\leq \frac{6.25(1+0.8v_d)}{(1+0.75\frac{\rho'}{\rho_{max}})} \frac{f_{ctm}}{f_{yd}}$	$\leq \frac{7.5(1+0.8v_d)}{(1+0.5\frac{\rho'}{\rho_{max}})} \frac{f_{ctm}}{f_{yd}}$	-
d_{bL}/h_c - bar anchored at exterior joint ⁽³⁾	$\leq 6.25(1+0.8v_d) \frac{f_{ctm}}{f_{yd}}$	$\leq 7.5(1+0.8v_d) \frac{f_{ctm}}{f_{yd}}$	-
<i>Transverse bars (w):</i>			
(i) outside critical regions			
spacing $s_w \leq$	0.75d		
$\rho_w \geq$	$0.08\sqrt{(f_{ck}(\text{MPa})/f_{yk}(\text{MPa}))^{(0)}}$		
(ii) in critical regions:			
$d_{bw} \geq$	6mm		
spacing $s_w \leq$	$6d_{bL}, \frac{h_w}{4}, 24d_{bw}, 175\text{mm}$	$8d_{bL}, \frac{h_w}{4}, 24d_{bw}, 225\text{mm}$	-
<i>Shear design:</i>			
V_{Ed} , seismic ⁽⁴⁾	$1.2 \frac{\sum M_{Rb}}{l_{cl}} \pm V_{o,g+\psi_2q}^{(4)}$	$\frac{\sum M_{Rb}}{l_{cl}} \pm V_{o,g+\psi_2q}^{(4)}$	from analysis for design seismic action plus gravity
$V_{Rd,max}$ seismic ⁽⁵⁾	As in EC2: $V_{Rd,max}=0.3(1-f_{ck}(\text{MPa})/250)b_w z f_{cd} \sin 2\delta^{(5)}$, $1 \leq \cot \delta \leq 2.5$		
$V_{Rd,s}$, outside critical regions ⁽⁵⁾	As in EC2: $V_{Rd,s}=b_w z \rho_w f_{ywd} \cot \delta^{(5)}$, $1 \leq \cot \delta \leq 2.5$		
$V_{Rd,s}$, critical regions ⁽⁵⁾	$V_{Rd,s}=b_w z \rho_w f_{ywd}$ ($\delta=45^\circ$)	As in EC2: $V_{Rd,s}=b_w z \rho_w f_{ywd} \cot \delta$, $1 \leq \cot \delta \leq 2.5$	
If $\zeta = V_{Emin}/V_{Emax}^{(6)} < -0.5$: inclined bars at angle $\pm\alpha$ to beam axis, with cross-section A_s /direction	If $V_{Emax}/(2+\zeta)f_{ctd}b_w d > 1$: $A_s=0.5V_{Emax}/f_{yd} \sin \alpha$ & stirrups for $0.5V_{Emax}$		-

- (0) NDP (Nationally Determined Parameter) according to Eurocode 2. The Table gives the value recommended in Eurocode 2.
- (1) μ_ϕ is the value of the curvature ductility factor that corresponds to the basic value, q_o , of the behaviour factor used in the design as: $\mu_\phi = 2q_o - 1$ if $T \geq T_C$ or $\mu_\phi = 1 + 2(q_o - 1)T_C/T$ if $T < T_C$.
- (2) The minimum area of bottom steel, $A_{s,min}$, is in addition to any compression steel that may be needed for the verification of the end section for the ULS in bending under the (absolutely) maximum negative (hogging) moment from the analysis for the design seismic action plus concurrent gravity, M_{Ed} .
- (3) h_c is the column depth in the direction of the bar, $v_d = N_{Ed}/A_c f_{cd}$ is the column axial load ratio, for the algebraically minimum value of the axial load due to the design seismic action plus concurrent gravity (compression: positive).
- (4) At a member end where the moment capacities around the joint satisfy: $\sum M_{Rb} > \sum M_{Rc}$, M_{Rb} is replaced in the calculation of the design shear force, V_{Ed} , by $M_{Rb}(\sum M_{Rc}/\sum M_{Rb})$
- (5) z is the internal lever arm, taken equal to $0.9d$ or to the distance between the tension and the compression reinforcement, $d-d_1$.
- (6) $V_{E,max}$, $V_{E,min}$ are the algebraically maximum and minimum values of V_{Ed} resulting from the \pm sign; $V_{E,max}$ is the absolutely largest of the two values, and is taken positive in the calculation of ζ ; the sign of $V_{E,min}$ is determined according to whether it is the same as that of $V_{E,max}$ or not.

Table 3.4.4 EN 1998 rules for detailing and dimensioning of primary columns (secondary ones as DCL)

	DCH	DCM	DCL
Cross-section sides, $h_c, b_c \geq$	0.25m; $h_v/10$ if $\theta = P\delta/Vh > 0.1^{(1)}$	-	
“critical region” length $^{(1)} \geq$	$1.5h_c, 1.5b_c, 0.6m, l_c/5$	$h_c, b_c, 0.45m, l_c/6$	h_c, b_c
<i>Longitudinal bars (L):</i>			
ρ_{min}	1%		$0.1N_d/A_c f_{yd}, 0.2\%^{(0)}$
ρ_{max}	4%		$4\%^{(0)}$
$d_{bL} \geq$	8mm		
bars per side \geq	3		2
Spacing between restrained bars	$\leq 150mm$	$\leq 200mm$	-
Distance of unrestrained bar from nearest restrained nearest restrained bar	$\leq 150mm$		
<i>Transverse bars (w):</i>			
Outside critical regions:			
$d_{bw} \geq$	6mm, $d_{bL}/4$		
spacing $s_w \leq$	$20d_{bL}, h_c, b_c, 400mm$	$12d_{bL}, 0.6h_c, 0.6b_c, 240mm$	
at lap splices, if $d_{bL} > 14mm: s_w \leq$	$12d_{bL}, 0.6h_c, 0.6b_c, 240mm$		
Within critical regions: ⁽²⁾			
$d_{bw} \geq$ ⁽³⁾	$6mm, 0.4(f_{yd}/f_{ywd})^{1/2}d_{bL}$	6mm, $d_{bL}/4$	
$s_w \leq$ ^{(3),(4)}	$6d_{bL}, b_o/3, 125mm$	$8d_{bL}, b_o/2, 175mm$	-
$\omega_{wd} \geq$ ⁽⁵⁾	0.08	-	
$\alpha\omega_{wd} \geq$ ^{(4),(5),(6),(7)}	$30\mu_\phi^* v_d \epsilon_{sy,d} b_c/b_o - 0.035$	-	
In critical region at column base:			
$\omega_{wd} \geq$	0.12	0.08	-
$\alpha\omega_{wd} \geq$ ^{(4),(5),(6),(8),(9)}	$30\mu_\phi v_d \epsilon_{sy,d} b_c/b_o - 0.035$		

Capacity design check at beam-column joints: ⁽¹⁰⁾	$1.3\sum M_{Rb} \leq \sum M_{Rc}$		-
Verification for M_x - M_y - N :	Truly biaxial, or uniaxial with $(M_z/0.7, N)$, $(M_y/0.7, N)$		
Axial load ratio $v_d = N_{Ed}/A_c f_{cd}$	≤ 0.55	≤ 0.65	-
<i>Shear design:</i>			
V_{Ed} seismic ⁽¹¹⁾	$1.3 \frac{\sum M_{Rc}^{ends}}{l_{cl}}$ ⁽¹¹⁾	$1.1 \frac{\sum M_{Rc}^{ends}}{l_{cl}}$ ⁽¹¹⁾	from analysis for design seismic action plus gravity
$V_{Rd,max}$ seismic ^{(12), (13)}	As in EC2: $V_{Rd,max} = 0.3(1-f_{ck}(\text{MPa})/250)b_{wo}z_{cg}\sin 2\delta$, $1 \leq \cot \delta \leq 2.5$		
$V_{Rd,s}$ seismic ^{(12), (13), (14)}	As in EC2: $V_{Rd,s} = b_w z_{pw} f_{ywd} \cot \delta + N_{Ed}(h-x)/l_{cl}$ ⁽¹³⁾ , $1 \leq \cot \delta \leq 2.5$		

(0) Note (0) of Table 3.4.3 applies.

(1) h_v is the distance of the inflection point to the column end further away, for bending within a plane parallel to the side of interest; l_c is the column clear length.

(2) For DCM: If a value of q not greater than 2 is used for the design, the transverse reinforcement in critical regions of columns with axial load ratio v_d not greater than 0.2 may just follow the rules applying to DCL columns.

(3) For DCH: In the two lower storeys of the building, the requirements on d_{bw} , s_w apply over a distance from the end section not less than 1.5 times the critical region length.

(4) Index c denotes the full concrete section and index o the confined core to the centreline of the perimeter hoop; b_o is the smaller side of this core.

(5) ω_{wd} is the ratio of the volume of confining hoops to that of the confined core to the centreline of the perimeter hoop, times f_y/f_{cd} .

(6) α is the "confinement effectiveness" factor, computed as $\alpha = \alpha_s \alpha_n$; where: $\alpha_s = (1-s/2b_o)(1-s/2h_o)$ for hoops and $\alpha_s = (1-s/2b_o)$ for spirals; $\alpha_n = 1$ for circular hoops and $\alpha_n = 1 - \{b_o/((n_h-1)h_o) + h_o/((n_b-1)b_o)\}/3$ for rectangular hoops with n_b legs parallel to the side of the core with length b_o and n_h legs parallel to the one with length h_o .

(7) For DCH: at column ends protected from plastic hinging through the capacity design check at beam-column joints, μ_θ is the value of the curvature ductility factor that corresponds to 2/3 of the basic value, q_o , of the behaviour factor used in the design (see Eqs. (5.2)); at the ends of columns where plastic hinging is not prevented because of the exemptions listed in Note (10) below, μ_θ is taken equal to μ_θ defined in Note (1) of Table 3.4.3 (see also Note (9) below); $\epsilon_{sy,d} = f_y/E_s$.

(8) Note (1) of Table 3.4.3 applies.

(9) For DCH: The requirement applies also in the critical regions at the ends of columns where plastic hinging is not prevented, because of the exemptions in Note (10) below.

(10) The capacity design check does not need to be fulfilled at beam-column joints: (a) of the top floor, (b) of the ground storey in two-storey buildings with axial load ratio v_d not greater than 0.3 in all columns, (c) if shear walls resist at least 50% of the base shear parallel to the plane of the frame (wall buildings or wall-equivalent dual buildings), and (d) in one-out-of-four columns of plane frames with columns of similar size.

(11) At a member end where the moment capacities around the joint satisfy: $\sum M_{Rb} < \sum M_{Rc}$, M_{Rc} is replaced by $M_{Rc}(\sum M_{Rb}/\sum M_{Rc})$.

(12) z is the internal lever arm, taken equal to 0.9d or to the distance between the tension and the compression reinforcement, $d-d_1$.

(13) The axial load, N_{Ed} , and its normalized value, v_d , are taken with their most unfavourable values for the shear verification under the design seismic action plus concurrent gravity (considering both the demand, V_{Ed} , and the capacity, V_{Rd}).

(14) x is the neutral axis depth at the end section in the ULS of bending with axial load.

Table 3.4.5 EN 1998 rules for the detailing and dimensioning of ductile walls

	DCH	DCM	DCL
Web thickness, $b_{wo} \geq$	$\max(150\text{mm}, h_{\text{storey}}/20)$		-
critical region length, h_{cr}	$\geq \max(l_w, H_w/6)$ ⁽¹⁾ $\leq \min(2l_w, h_{\text{storey}})$ if wall ≤ 6 storeys $\leq \min(2l_w, 2h_{\text{storey}})$ if wall > 6 storeys		-
<i>Boundary elements:</i>			
a) in critical region:			

- length l_c from edge \geq	0.15 l_w , 1.5 b_w , length over which $\varepsilon_c > 0.0035$		-
- thickness b_w over $l_c \geq$	0.2m; $h_{st}/15$ if $l_c \leq \max(2b_w, l_w/5)$, $h_{st}/10$ if $l_c > \max(2b_w, l_w/5)$		-
- vertical reinforcement:			
ρ_{min} over $A_c = l_c b_w$	0.5%		0.2% ⁽⁰⁾
ρ_{max} over A_c	4% ⁽⁰⁾		
- confining hoops (w) ⁽²⁾ :			
$d_{bw} \geq$	6mm, $0.4(f_{yd}/f_{ywd})^{1/2} d_{bL}$	6mm,	in the part of the section where $\rho_L > 2\%$: as over the rest of the wall (case b, below)
spacing $s_w \leq$ ⁽³⁾	$6d_{bL}$, $b_o/3$, 125mm	$8d_{bL}$, $b_o/2$, 175mm	
$\omega_{wd} \geq$ ⁽²⁾	0.12	0.08	
$\alpha \omega_{wd} \geq$ ^{(3),(4)}	$30\mu_\phi(v_d + \omega_v)\varepsilon_{sy,d} b_w/b_o - 0.035$		
b) over the rest of the wall height:	<p>In parts of the section where $\varepsilon_c > 0.2\%$: $\rho_{v,min} = 0.5\%$; elsewhere 0.2%</p> <p>In parts of the section where $\rho_L > 2\%$:</p> <p>distance of unrestrained bar in compression zone from nearest restrained bar $\leq 150\text{mm}$;</p> <p>hoops with $d_{bw} \geq \max(6\text{mm}, d_{bL}/4)$ & spacing $s_w \leq \min(12d_{bL}, 0.6b_{wo}, 240\text{mm})$⁽⁰⁾ up to a distance of $4b_w$ above or below floor beams or slabs, or $s_w \leq \min(20d_{bL}, b_{wo}, 400\text{mm})$⁽⁰⁾ beyond that distance</p>		
<i>Web:</i>			
- vertical bars (v):			
$\rho_{v,min}$	Wherever in the section $\varepsilon_c > 0.2\%$: 0.5%; elsewhere 0.2%		0.2% ⁽⁰⁾
$\rho_{v,max}$	4%		
$d_{bv} \geq$	8mm	-	
$d_{bv} \leq$	$b_{wo}/8$	-	
spacing $s_v \leq$	$\min(25d_{bv}, 250\text{mm})$	$\min(3b_{wo}, 400\text{mm})$	
- horizontal bars:			
ρ_{hmin}	0.2%	$\max(0.1\%, 0.25\rho_v)$ ⁽⁰⁾	
$d_{bh} \geq$	8mm	-	
$d_{bh} \leq$	$b_{wo}/8$	-	
spacing $s_h \leq$	$\min(25d_{bh}, 250\text{mm})$	400mm	
axial load ratio $v_d = N_{Ed}/A_c f_{cd}$	≤ 0.35	≤ 0.4	-
Design moments M_{Ed} :	If $H_w/l_w \geq 2$, design moments from linear envelope of maximum moments M_{Ed} from analysis for the "seismic design situation", shifted up by the "tension shift" a_l		from analysis for design seismic action & gravity
<i>Shear design:</i>			
Design shear force V_{Ed} = shear force V'_{Ed} from the analysis for the design seismic action, times factor ε :	<p>if $H_w/l_w \leq 2$⁽⁵⁾: $\varepsilon = 1.2M_{Rdo}/M_{Edo} \leq q$</p> <p>if $H_w/l_w > 2$^{(5), (6)}:</p> $\varepsilon = \sqrt{\left(1.2 \frac{M_{Rdo}}{M_{Edo}}\right)^2 + 0.1 \left(q \frac{S_e(T_C)}{S_e(T_1)}\right)^2} \leq q$	$\varepsilon = 1.5$	$\varepsilon = 1.0$

Design shear force in walls of dual systems with $H_w/l_w > 2$, for z between $H_w/3$ and H_w : ⁽⁷⁾	$V_{Ed}(z) = \left(\frac{0.75z}{H_w} - \frac{1}{4} \right) \varepsilon V_{Ed}(0) + \left(1.5 - \frac{1.5z}{H_w} \right) \varepsilon V_{Ed} \left(\frac{H_w}{3} \right)$		from analysis for design seismic action & gravity
$V_{Rd,max}$ outside critical region	As in EC2: $V_{Rd,max} = 0.3(1-f_{ck}(\text{MPa})/250)b_{wo}(0.8l_w)f_{cd}\sin 2\delta$, with $1 \leq \cot \delta \leq 2.5$		
$V_{Rd,max}$ in critical region	40% of EC2 value	As in EC2	
$V_{Rd,s}$ in critical region; web reinforcement ratios: ρ_h, ρ_v			
(i) if $\alpha_s = M_{Ed}/V_{Ed}l_w \geq 2$: $\rho_v = \rho_{v,min}, \rho_h$ from $V_{Rd,s}$:	$V_{Rd,s} = b_{wo}(0.8l_w)\rho_h f_{ywd}$	As in EC2: $V_{Rd,s} = b_{wo}(0.8l_w)\rho_h f_{ywd} \cot \delta$, $1 \leq \cot \delta \leq 2.5$	
(ii) if $\alpha_s < 2$: ρ_h from $V_{Rd,s}$: ⁽⁸⁾ ρ_v from: ⁽⁹⁾	$V_{Rd,s} = V_{Rd,c} + b_{wo}\alpha_s(0.75l_w)\rho_h f_{yhd}$ $\rho_v f_{yvd} \geq \rho_h f_{yhd} - N_{Ed}/(0.8l_w b_{wo})$	As in EC2: $V_{Rd,s} = b_{wo}(0.8l_w)\rho_h f_{ywd} \cot \delta$, $1 \leq \cot \delta \leq 2.5$	
Resistance to sliding shear: via bars with total area A_{si} at angle $\pm \alpha$ to the horizontal ⁽¹⁰⁾	$V_{Rd,s} = A_{si} f_{yd} \cos \alpha + A_{sv} \min(0.25f_{yd}, 1.3\sqrt{f_{yd}f_{cd}}) + 0.3(1-f_{ck}(\text{MPa})/250)b_{wo} x f_{cd}$		
$\rho_{v,min}$ at construction joints ^{(9),(11)}	$0.0025 \frac{1.3f_{ctd} - \frac{N_{Ed}}{A_c}}{f_{yd} + 1.5\sqrt{f_{ctd}f_{yd}}}$		-

(0) Note (0) of Tables 3.4.3 and 3.4.4 applies.

(1) l_w is the long side of the rectangular wall section or rectangular part thereof; H_w is the total height of the wall; h_{storey} is the storey height.

(2) For DC M: If, under the maximum axial force in the wall from the analysis for the design seismic action plus concurrent gravity the wall axial load ratio $v_d = N_{Ed}/A_c f_{cd}$ satisfies $v_d \leq 0.15$, the DCL rules may be applied for the confining reinforcement of boundary elements; these DCL rules apply also if this value of the wall axial load ratio is $v_d \leq 0.2$ but the value of q used in the design of the building is not greater than 85% of the q -value allowed when the DC M confining reinforcement is used in boundary elements.

(3) Notes (4), (5), (6) of Table 3.4.4 apply for the confined core of boundary elements.

(4) μ_ϕ is the value of the curvature ductility factor that corresponds as: $\mu_\phi = 2q_0 - 1$ if $T \geq T_c$ or $\mu_\phi = 1 + 2(q_0 - 1)T_c/T$ if $T < T_c$, to the product of the basic value q_0 of the behaviour factor times the value of the ratio M_{Edo}/M_{Rdo} at the base of the wall (see Note (5)); $\varepsilon_{sy,d} = f_{yd}/E_s$, $\omega_{v,d}$ is the mechanical ratio of the vertical web reinforcement.

(5) M_{Edo} is the moment at the wall base from the analysis for the design seismic action plus concurrent gravity; M_{Rdo} is the design value of the flexural capacity at the wall base for the axial force N_{Ed} from the same analysis (design seismic action plus concurrent gravity).

(6) $S_e(T_1)$ is the value of the elastic spectral acceleration at the period of the fundamental mode in the horizontal direction (closest to that) of the wall shear force multiplied by ε ; $S_e(T_c)$ is the spectral acceleration at the corner period T_c of the elastic spectrum.

(7) A dual structural system is one in which walls resist between 35 and 65% of the seismic base shear in the direction of the wall shear force considered; z is distance from the base of the wall.

(8) For b_w and d in m, f_{cd} in MPa, ρ_L denoting the tensile reinforcement ratio, N_{Ed} in kN, $V_{Rd,c}$ (in kN) is given by:

$$V_{Rd,c} = \left\{ \max \left[180(100\rho_1)^{1/3}, 35\sqrt{1 + \frac{0.2}{d}} f_{cd}^{1/6} \right] \left(1 + \sqrt{\frac{0.2}{d}} \right) f_{cd}^{1/3} + 0.15 \frac{N_{Ed}}{A_c} \right\} b_w d$$

N_{Ed} is positive for compression; its minimum value from the analysis for the design seismic action plus concurrent gravity is used; if the minimum value is negative (tension), $V_{Rd,c} = 0$.

(9) N_{Ed} is positive for compression; its minimum value from the analysis for the design seismic action plus concurrent gravity is used.

(10) A_{sv} is the total area of web vertical bars and of any additional vertical bars placed in boundary elements against shear sliding; x is the depth of the compression zone.

(11) $f_{ctd} = f_{ctk,0.05}/\gamma_c$ is the design value of the (5%-fractile) tensile strength of concrete.

3.5 Outcome of the detailed design

3.5.1 DESIGN MOMENT AND SHEAR ENVELOPES OF THE WALLS

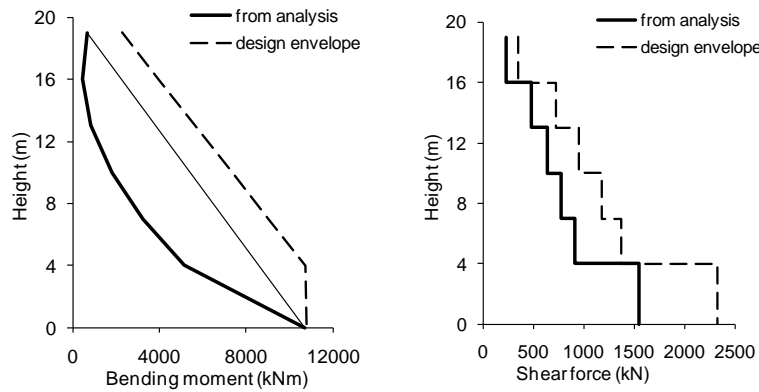

Fig. 3.5.1 Design envelope for bending moment (left) and shear (right) of wall W1

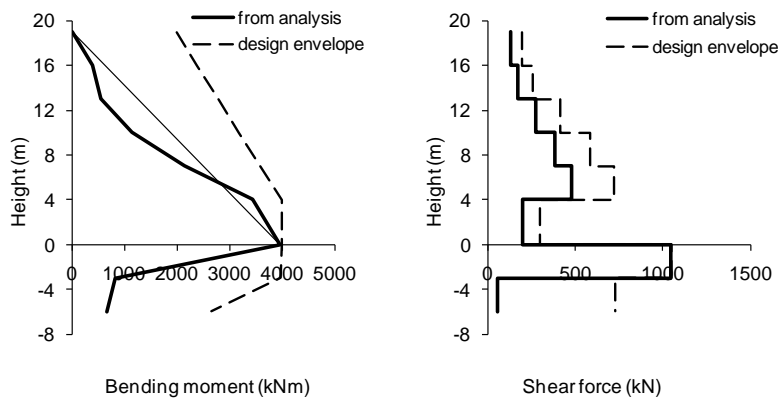

Fig. 3.5.2 Design envelope for bending moment (left) and shear (right) of wall W3

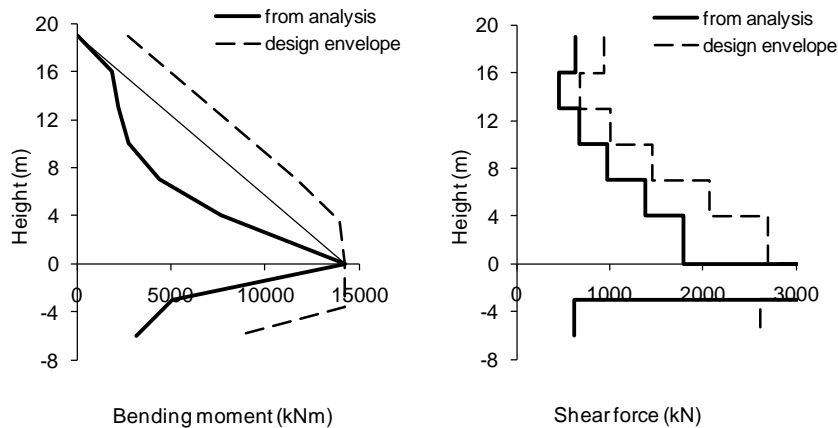

Fig. 3.5.3 Design envelope for bending moment (left) and shear (right) of wall W5 and direction X

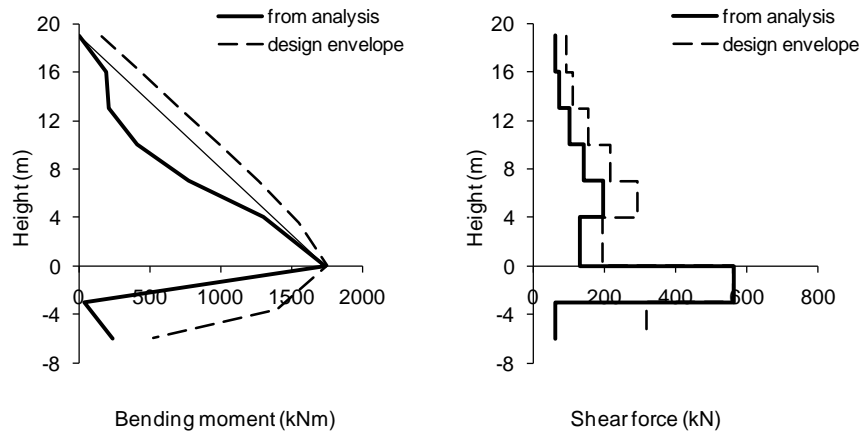

Fig. 3.5.4 Design envelope for bending moment (left) and shear (right) of wall W5 and direction Y

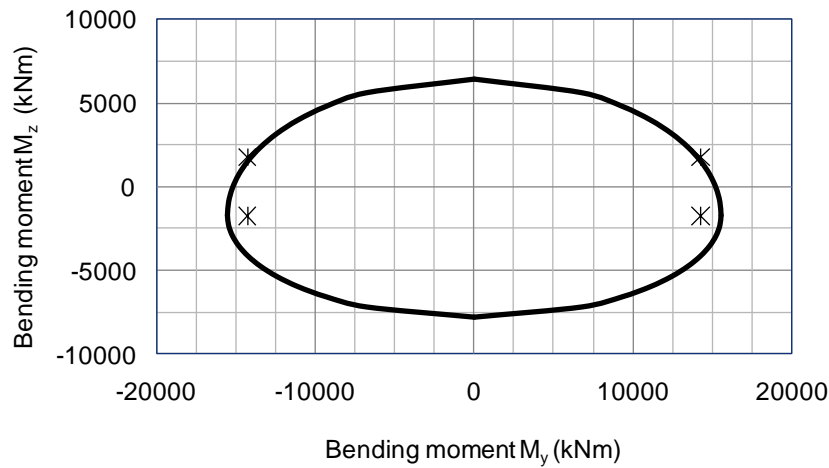

Fig. 3.5.5 M_x - M_y interaction diagram for wall W5 (stars indicate the design action effects)

3.5.2 REINFORCEMENT DRAWINGS

The following figures show framing plans with the longitudinal reinforcement of the beams and of the footings. The reinforcement of the columns and the walls are depicted in sections of these elements.

The complete design of all elements in the building is given in Annex 3.A

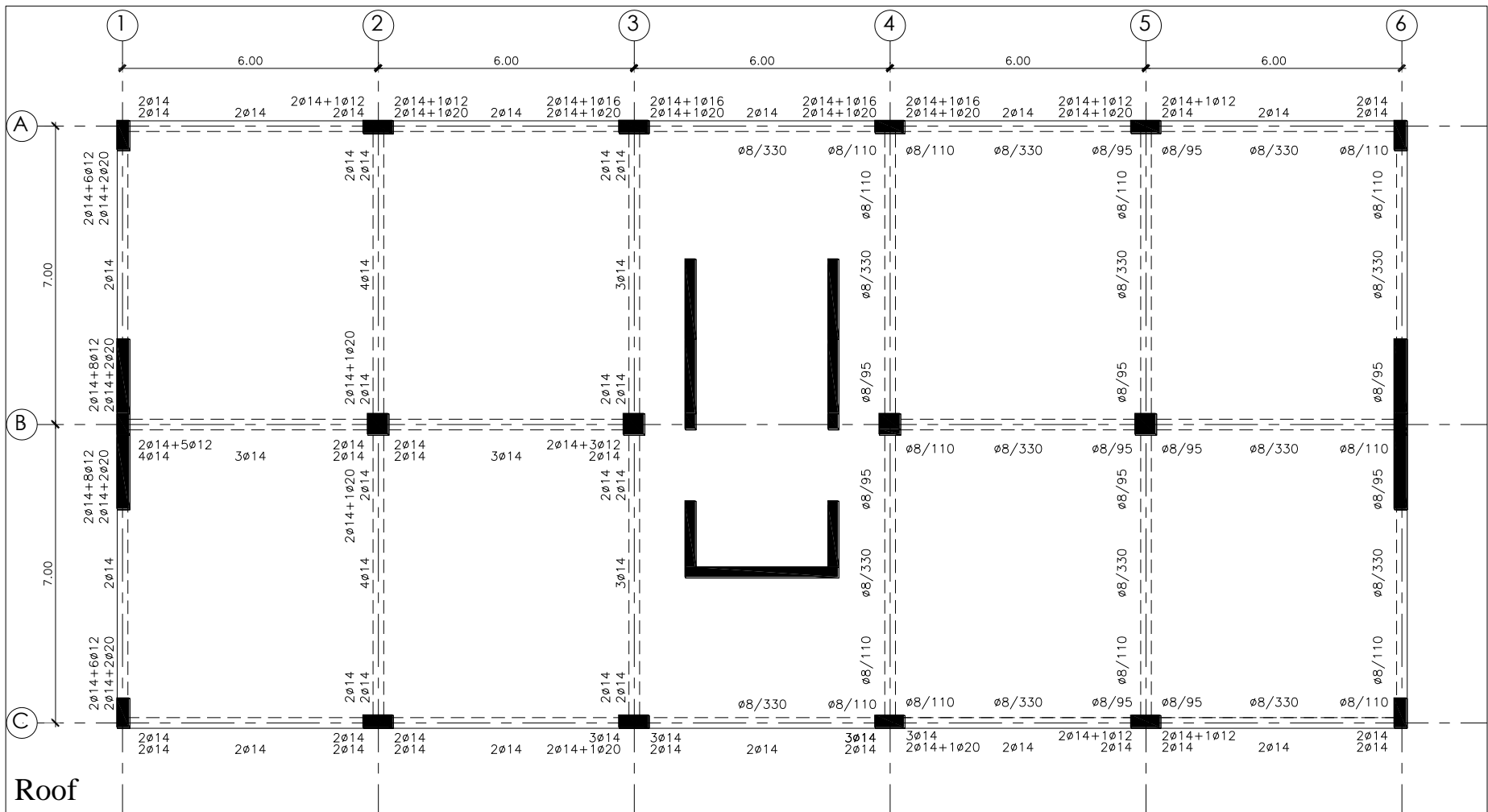
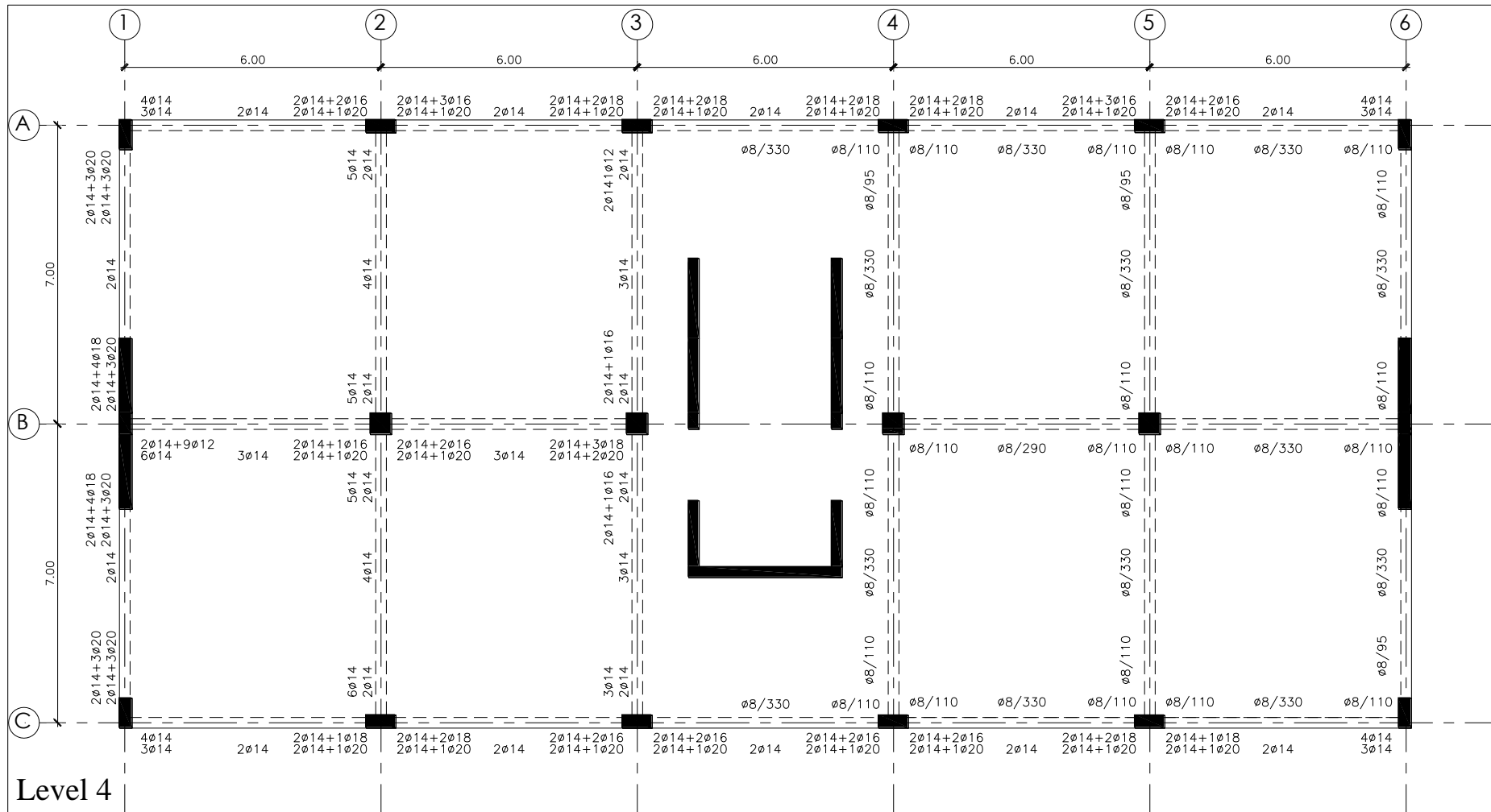

Fig. 3.5.6 Beam framing plan at roof



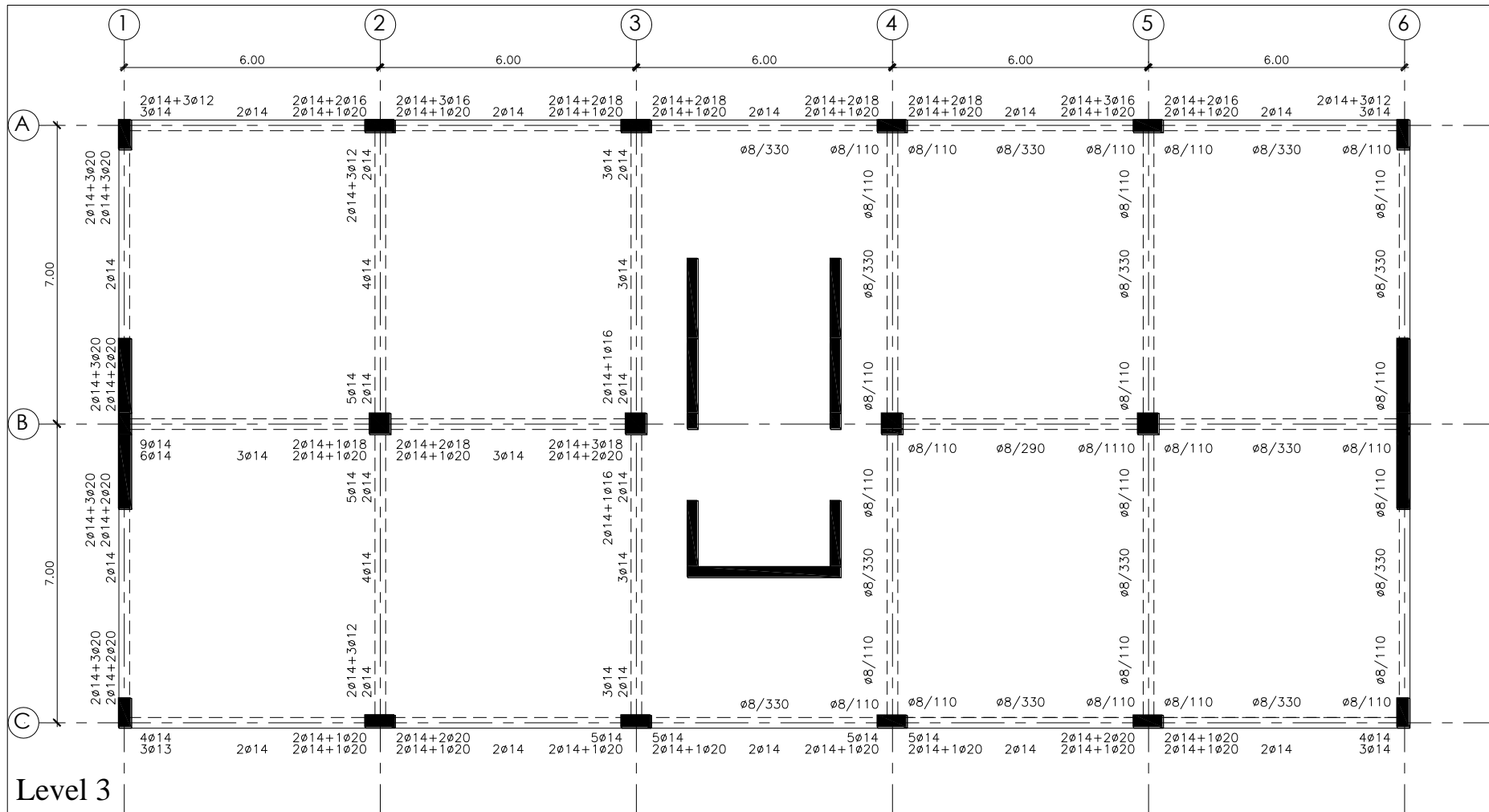

Fig. 3.5.9 Beam framing plan at storey 3

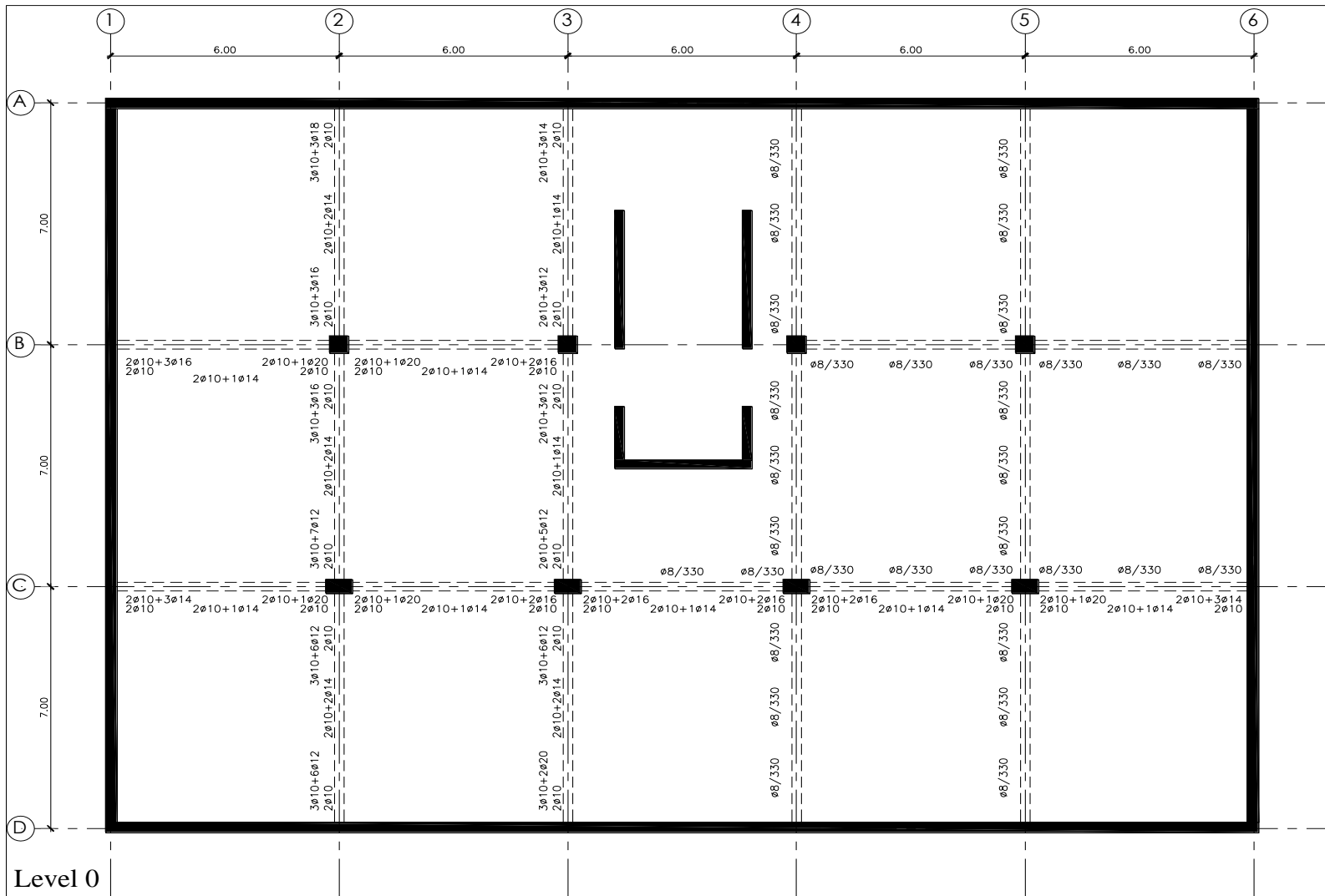

Fig. 3.5.12 Beam framing plan at storey 0

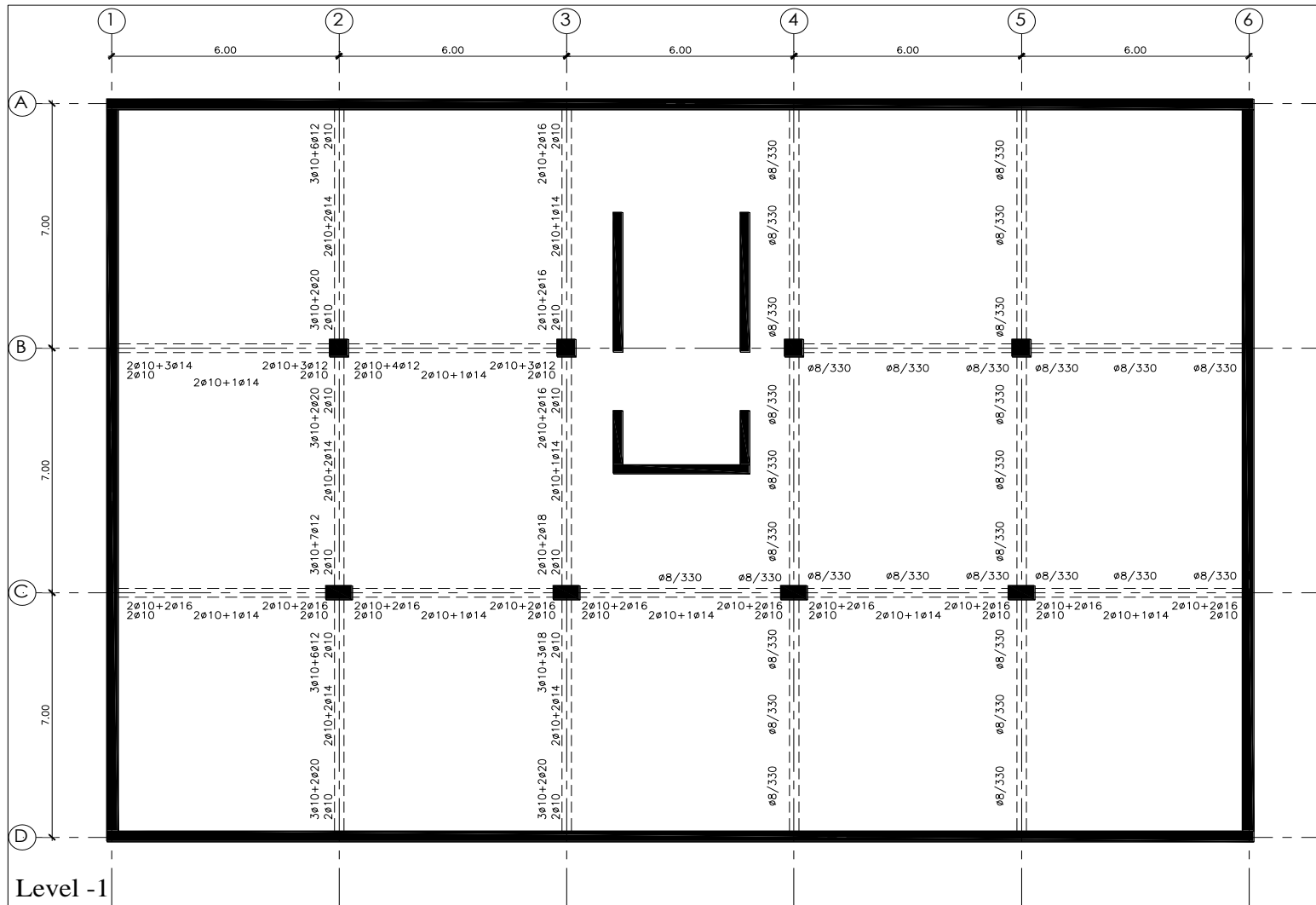

Fig. 3.5.13 Beam framing plan at storey -1

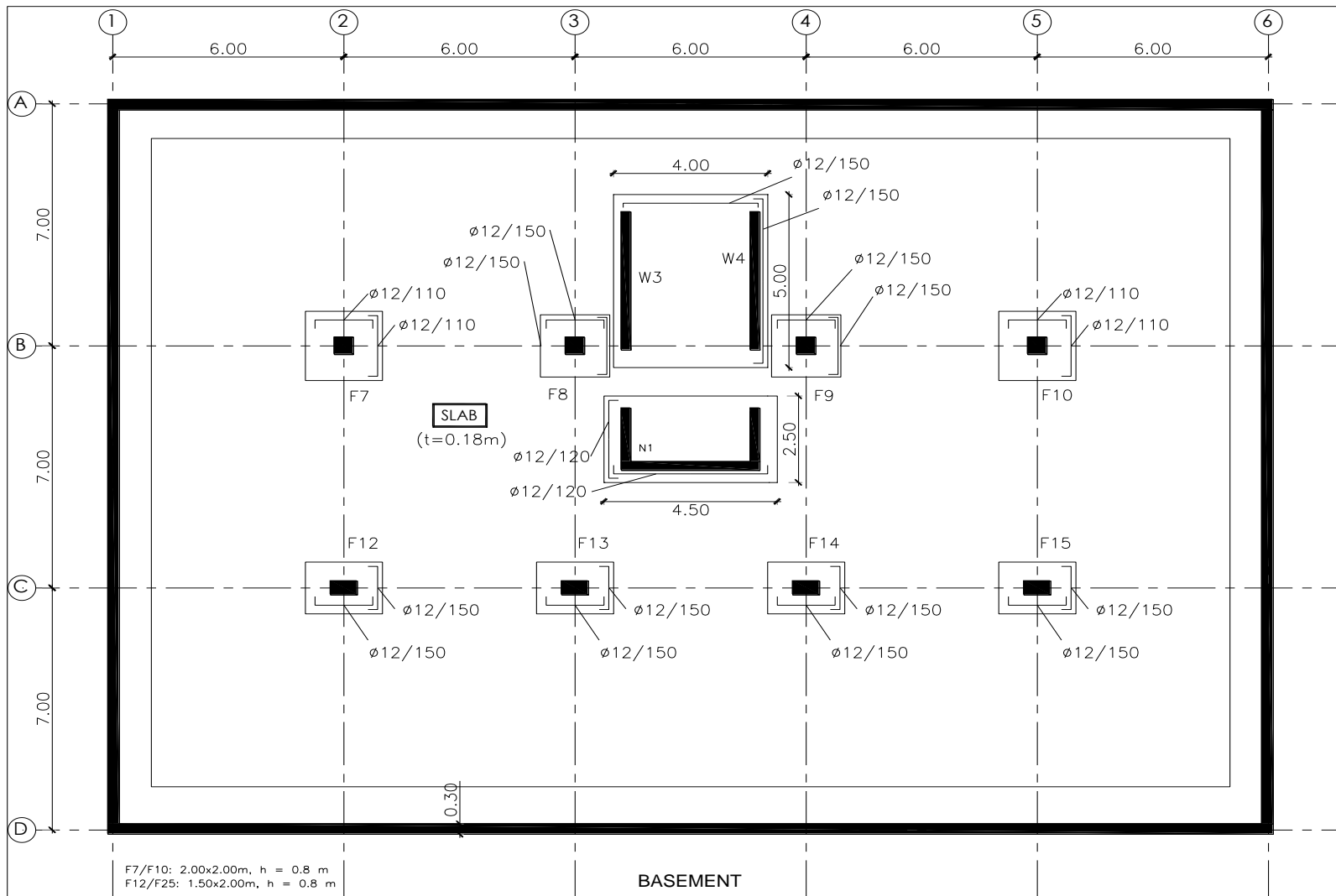

Fig. 3.5.14 Reinforcement of footings

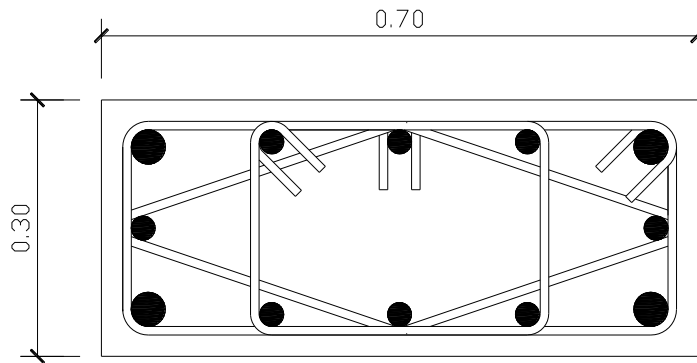

Fig. 3.5.15 Cross-section of columns C1 to C6 and C11 to C16 (longitudinal reinforcement 4Φ16 & 8Φ14)

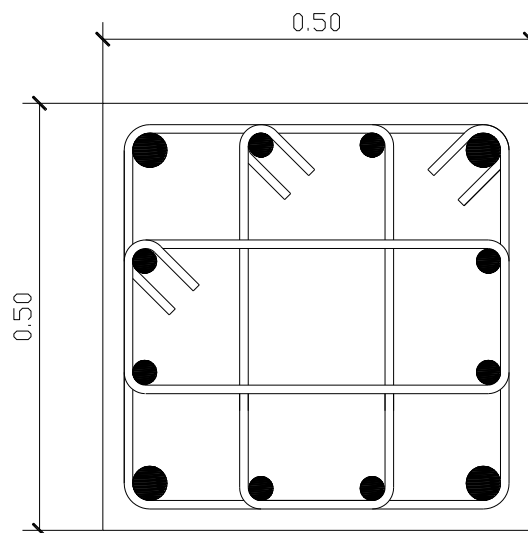

Fig. 3.5.16 Cross-section of columns C7, C8, C9 and C10 (longitudinal reinforcement 4Φ18 & 8Φ14)

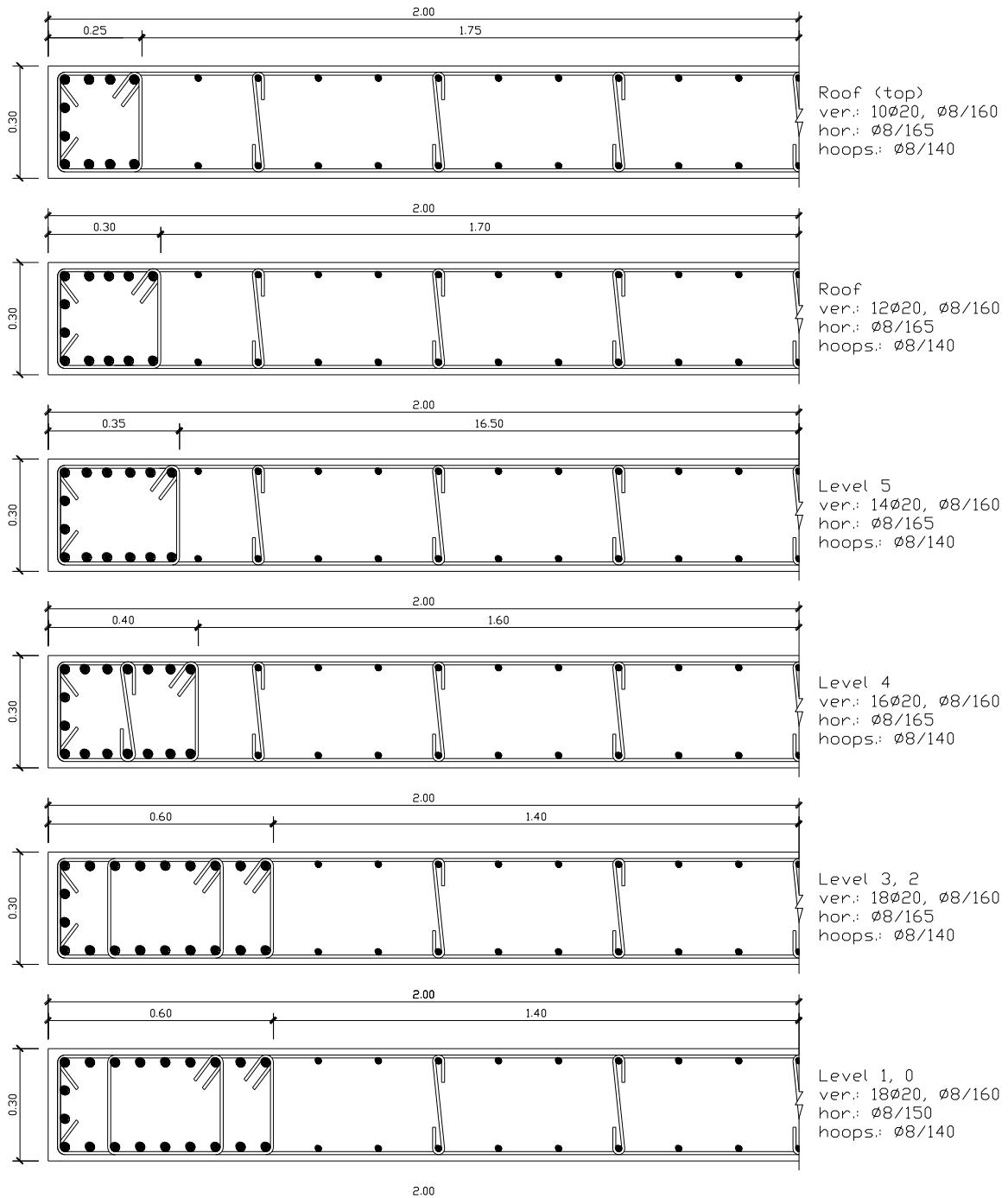

Fig. 3.5.17 Longitudinal reinforcement of wall W1

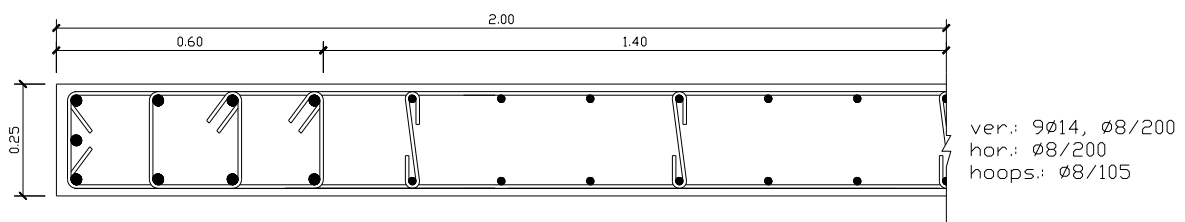

Fig. 3.5.18 Longitudinal reinforcement of wall W3

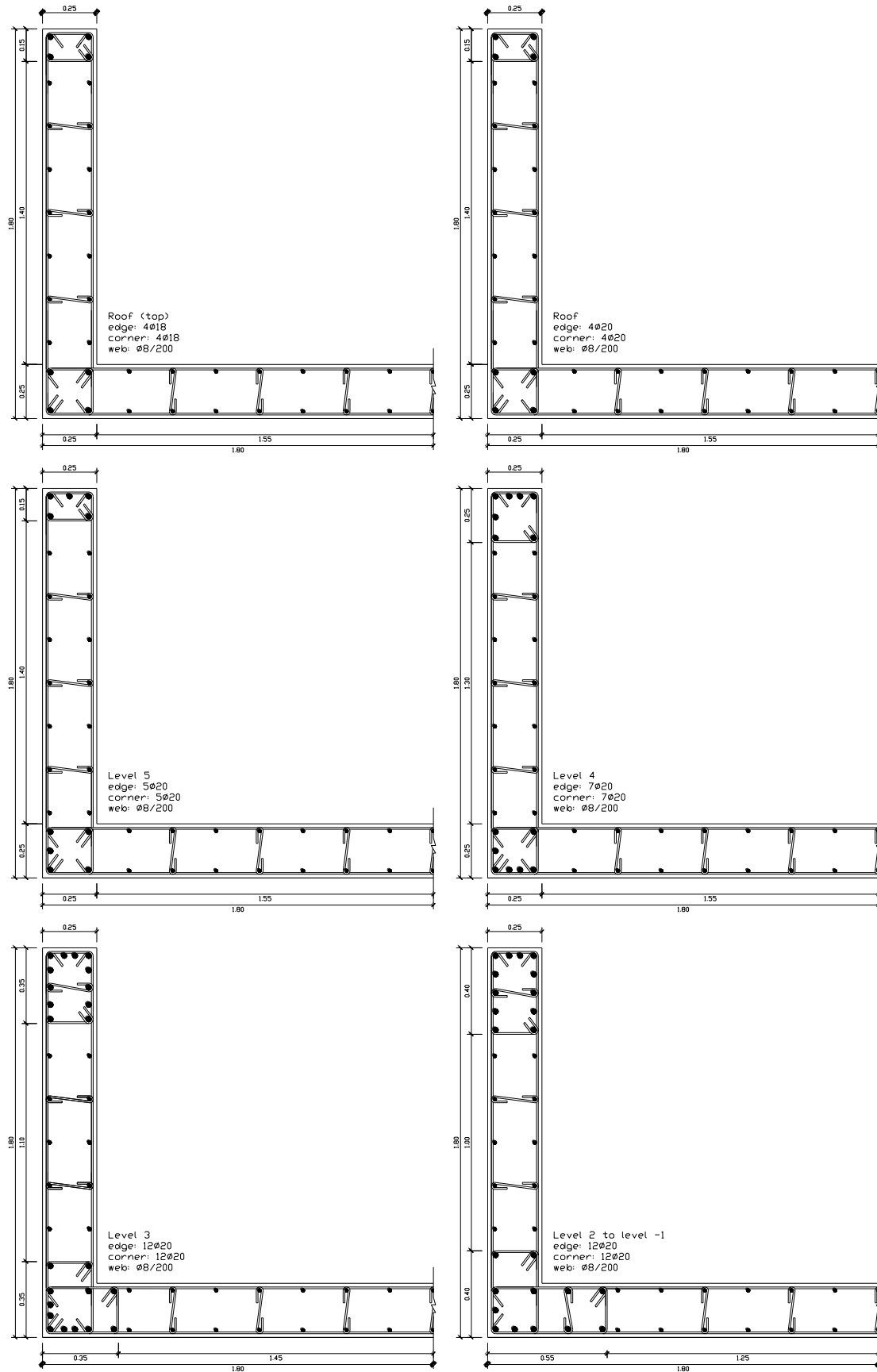

Fig. 3.5.19 Longitudinal reinforcement of wall W

CHAPTER 4

**Introduction to the RC building example. Modeling and analysis of
the design example**

A. Pecker

Geodynamique and Structure

4.1 Introduction

EN 1998-5 addresses the requirements, criteria and rules for soils and foundations in earthquake prone areas. It covers the identification of the relevant soil parameters, the design of different foundation systems, the design of earth retaining structures, the stability of slopes, and touches, in a qualitative way, upon the effect of soil structure interaction on the seismic response of structures. According to the scope of this part of Eurocode 8, it complements Eurocode 7 (the geotechnical Eurocode) that does not cover the special requirements of seismic design. Eurocode 7 (EN 1997) states that "EN 1998 provides additional rules for geotechnical seismic design, which complete or adapt the rules of this standard".

A particular feature of Eurocode 8-Part 5 is that it applies to buildings (EN 1998-1), bridges (EN 1998-2), towers, masts and chimneys (EN 1998-6), silos, tanks and pipelines (EN 1998-4). As a consequence, all requirements for foundations and soils are found in this part of Eurocode 8 and only specialized requirements of certain types of structures may be found in the other relevant parts of EN 1998.

This paper will attempt to present the links and common features with Eurocode 7 and then detail most of the aspects covered in EN 1998-5 with emphasis on foundations, illustrated by the detailed example of the seismic calculations of a shallow foundations. This example is taken from the design presented in other chapters of this book. For further details on Eurocode 7, the reader can refer to R. Frank (General presentation of Eurocode 7 on 'Geotechnical design', *Seminar on Eurocodes, Hong Kong, 5th May 2008*).

4.2 Selection of geotechnical parameters

4.2.1 DEFINITION OF DESIGN VALUES

Many geotechnical tests, particularly field tests, do not allow basic geotechnical parameters or coefficients, for example for strength and deformation, to be determined directly. Instead, values of these parameters and coefficients must be derived using theoretical or empirical correlations. The concept of 'derived values' had been introduced in EN 1997, in order to give status to correlations and models commonly used to obtain, from field tests and laboratory tests, geotechnical parameters and coefficients which enter directly into the design. The definition of derived values is given in Eurocode 7 – Part 2 as: '*Derived values of geotechnical parameters and/or coefficients are obtained from test results by theory, correlation or empiricism.*' From field test results, the geotechnical parameter obtained is either an input for an analytical or indirect model or a coefficient for use in a semi-empirical or direct model of foundation design. Derived values of a geotechnical parameter then serve as input for assessing the characteristic value of this parameter in the sense of Eurocode 7 - Part 1 and, further, its design value, by applying the partial factor γ_M ('material factor'). The role played by the derived values of geotechnical parameters can be understood with the help of Figure 4.2.1, taken from Eurocode 7 - Part 2.

The philosophy with regard to the definition of characteristic values of geotechnical parameters is contained in Eurocode 7 – Part 1 (clause 2.4.5.2 in EN1997-1) : '*The characteristic value of a geotechnical parameter shall be selected as a cautious estimate of the value affecting the occurrence of the limit state.*' '*[...]the governing parameter is often the mean of a range of values covering a large surface or volume of the ground. The characteristic value should be a cautious estimate of this mean value.*' These paragraphs in Eurocode 7 – Part 1 reflect the concern that one should be able to keep using the values of the geotechnical parameters that were traditionally used (the determination

of which is not standardized, i.e. they often depend on the individual judgment of the geotechnical engineer). However two remarks should be made at this point : on the one hand, the concept of 'derived value' of a geotechnical parameter (preceding the determination of the characteristic value), has been introduced and, on the other hand, there is now a clear reference to the limit state involved and to the assessment of the mean value (and not a local value; this might appear to be a specific feature of geotechnical design which, indeed, involves 'large' areas or 'large' ground masses).

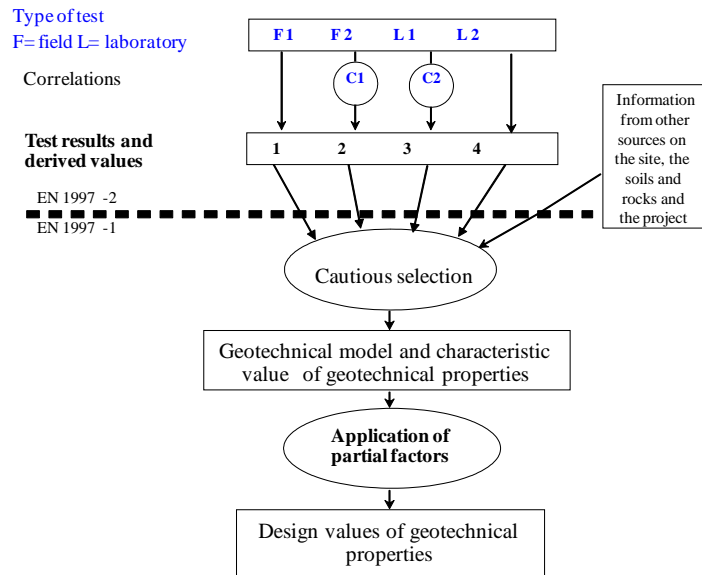

Fig. 4.2.1 General framework for the selection of derived values, characteristic values and design values of geotechnical properties

Statistical methods are mentioned only as a possibility: 'If statistical methods are used, the characteristic value should be derived such that the calculated probability of a worse value governing the occurrence of the limit state under consideration is not greater than 5%'. The general feeling is that the characteristic value of a geotechnical parameter cannot be fundamentally different from the value that was traditionally used. Indeed, for the majority of projects, the geotechnical investigation is such that no serious statistical treatment of the data can be performed. Statistical methods are, of course, useful for very large projects where the amount of data justifies them.

The relationship of characteristics values to design values is governed by the general prescription of EN 1990, namely the design value X_d of a geotechnical parameter is obtained as:

$$X_d = \frac{X_k}{\gamma_M} \quad (4.1)$$

where X_k is the characteristic value and γ_M a partial factor for the parameter, subject to national choice (NDP parameter).

4.2.2 SOIL PROPERTIES

Eurocode 8 considers both the strength properties and the deformation characteristics; it further recognizes that earthquake loading is essentially a short duration loading. Consequently most soils behave in an undrained manner and that for some of them the properties may be affected by the rate of loading.

4.2.2.1 Strength properties

For cohesive soils the relevant strength characteristic is the undrained shear strength C_u . For most materials this value can be taken equal to the conventional "static" shear strength. However, on the one hand, some plastic clays may be subject to cyclic degradation with a loss of strength and, on the other hand, some clays may exhibit a shear strength increase with the rate of loading. These phenomena should ideally be given due consideration in the choice of the relevant undrained shear strength. The recommended partial factor γ_M on C_u is equal to 1.4.

For cohesionless soils the relevant properties are the drained friction angle φ' and the drained cohesion c' . These parameters are directly usable for dry or partially saturated soil; for saturated soils they would require the knowledge of the pore water pressure variation, u , during cyclic loading, which directly governs the shear strength through the Mohr Coulomb failure criterion:

$$\tau = (\sigma - u) \tan \varphi' + c' \quad (4.2)$$

This evaluation is very difficult; therefore EN 1998-5 suggest an alternative approach which consists in using the undrained shear strength under cyclic loading, $\tau_{cy,u}$. This undrained shear strength may be determined from experimental relationships with, for instance, the soil relative density or any other index parameter like the blow counts, N , measured in Standard Penetration Tests (SPT). The recommended partial factors γ_M are equal to 1.25 on $\tan(\varphi')$ and $\tau_{cy,u}$ and to 1.4 on c' .

4.2.2.2 Deformation characteristics

The soil stiffness is defined by the shear wave velocity, V_s , or equivalently the soil shear modulus G . The main role played by this parameter is in the classification of the soil profile according to the ground types defined in EN 1998-1. Additional applications that require knowledge of the shear stiffness of the soil profile include the evaluation of:

- o Soil structure interaction,
- o The seismic coefficient k_h to be used in the calculation of earth pressure for high retaining structures ($H > 10\text{m}$) when a site response analysis is performed,
- o Site response analyses to define the ground surface response for special soil categories (profile S_1).

However in the applications listed above it is essential to recognize that soils are highly nonlinear materials and that the relevant values to use in the calculation models are not the elastic ones but secant values compatible with the average strain level induced by the earthquake, typically of the order of $5 \cdot 10^{-4}$ to 10^{-3} . EN 1998-5 proposes a set of values correlated to the peak ground surface acceleration (Table 4.2.1). It is must be recognized that the fundamental parameter that governs the reduction factor is the shear strain and not the peak ground surface acceleration but, in order to provide useful guidance to designers the induced strains have been correlated to peak ground accelerations.

Table 4.2.1 Average soil damping ratio and average reduction factors (for $V_{Smax} < 360\text{m/s}$)

Ground acceleration Ratio αS	Damping ratio	V_s / V_{Smax}	G_s / G_{Smax}
0.1	0.03	0.9 (± 0.07)	0.8 (± 0.1)
0.2	0.06	0.7 (± 0.15)	0.5 (± 0.2)
0.3	0.10	0.6 (± 0.15)	0.36 (± 0.2)

In addition to the stiffness parameters, soil internal damping shall be considered in soil structure interaction analyses. Soil damping ratio also depends on the average induced shear strain and is correlated to the reduction factor for the stiffness. Appropriate values are listed in Table 4.2.1.

4.3 Design approaches

EN 1997-1 introduces three alternative design approaches to geotechnical problems, denoted DA-1, DA-2 and DA-3. Each design approach introduces partial factors that affect either directly the actions, the action effects, the global resistance, or the strength parameters.

- o As illustrated in Figure 4.3.1 (Frank, 2008) approach DA-1 C1 introduces partial factors on the actions (γ_G, γ_Q):

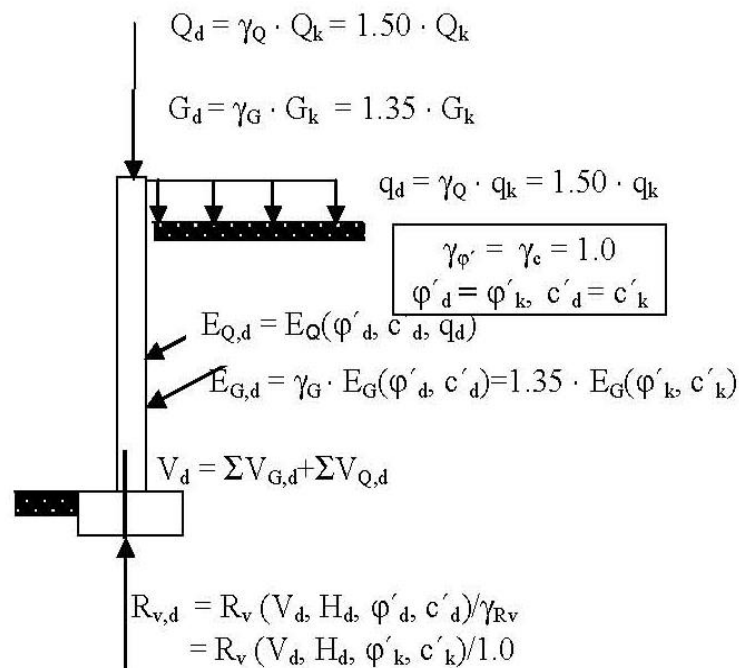

Fig. 4.3.1 Design approach DA-1 C1

- o Design approach DA-1 C2 introduces partial factors (γ_ϕ , γ_c) on the ground strength parameters (Figure 4.3.2):

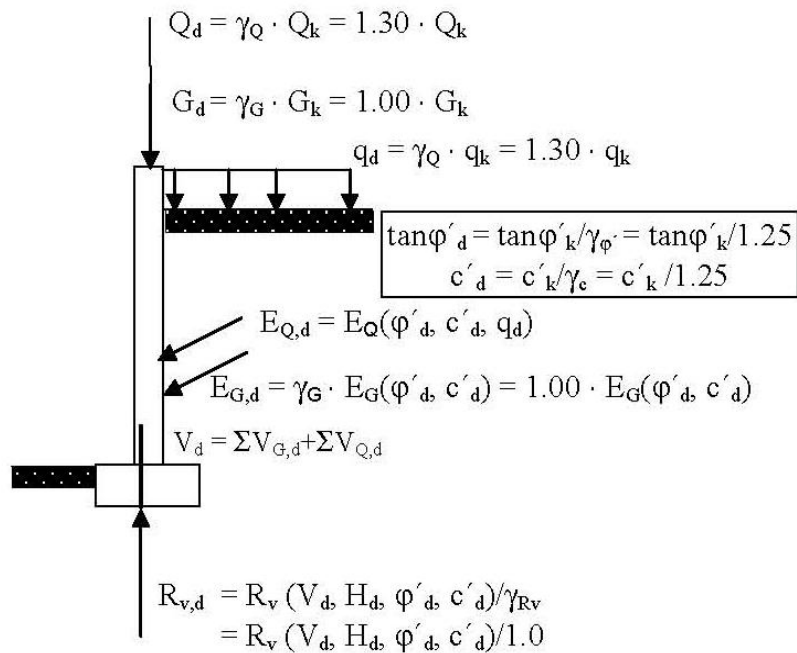

Fig. 4.3.2 Design approach DA-1 C2

- o Design approach DA-2 introduces partial factors on actions (or action effects) and on the global resistance (γ_G , γ_Q , γ_{Rv}) (Figure 4.3.3).

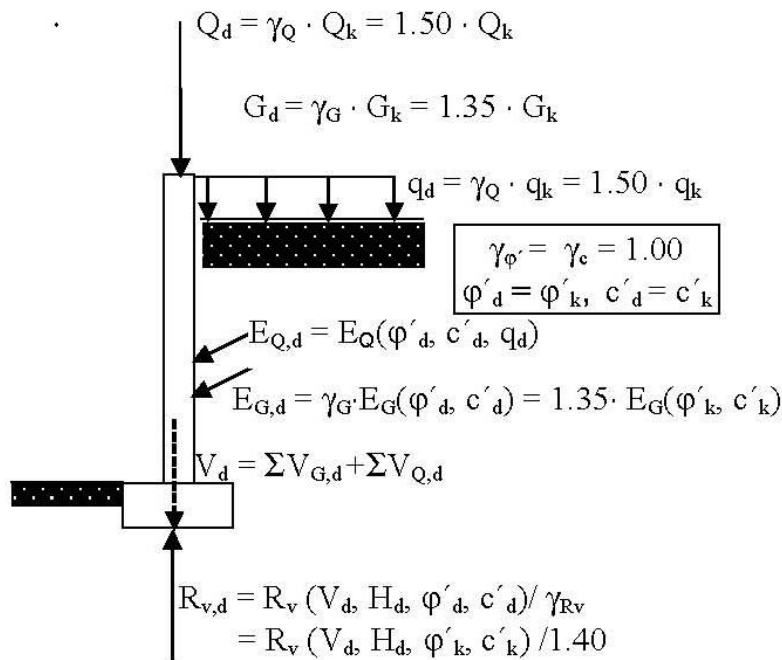

Fig. 4.3.3 Design approach DA-2

- o Design approach DA-3 introduced partial factors on structure generated actions and on ground strength parameters (γ_G, γ_Q to G_k and $Q_k, \gamma_\phi, \gamma_c$) (Figure 4.3.4).

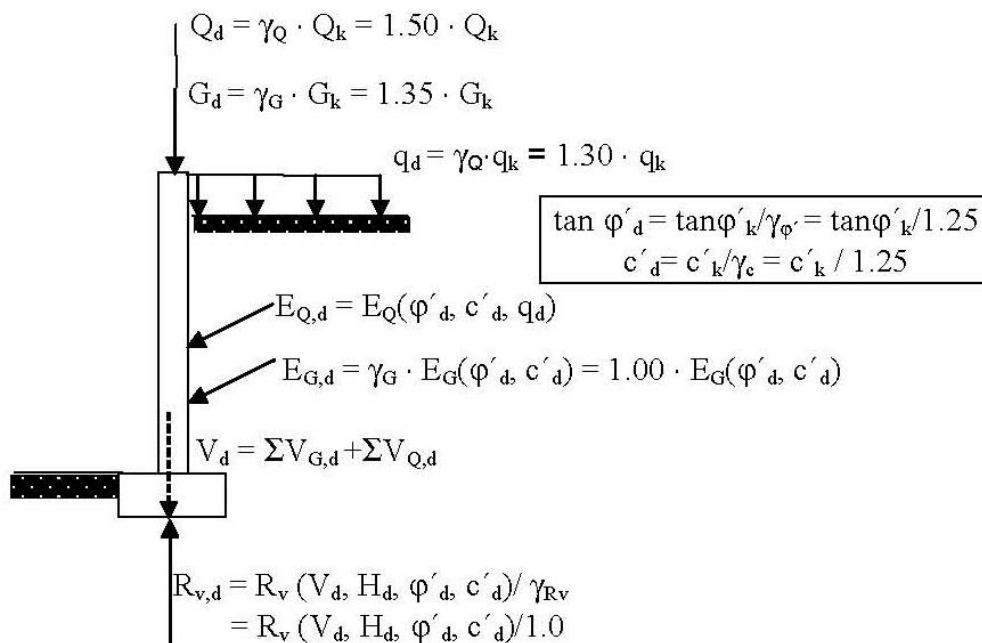

Fig. 4.3.4 Design approach DA-3

As seen from the previous figures approach DA-3 coincides with approach DA-1 C2 when structure-generated actions are absent. In EN 1998-5, structure-generated actions, such as the inertial forces transmitted to the ground through the foundations, are combined according to the rules specified in EN 1998-1.

In EN 1998-5, there is no explicit mention of design approaches. However, the pseudo static methods recommended for stability verifications assume ground strength parameters in agreement with DA-3. Therefore, the implicit design approach followed in EN 1998-5 is design approach DA-3.

4.4 Requirement for construction sites

A common requirement in any seismic building code is to prevent construction in the immediate vicinity of a seismically active fault. Eurocode 8 requires that buildings of importance category II, III or IV be not erected in the immediate vicinity of such faults. The rationale behind this prescription is illustrated in Figure 4.4.1 depicting the movements caused by a fault offset during the Chi-Chi earthquake in Taiwan (1999). Designing a structure for such large movements (9m in the present case) is beyond our capability.

It must however be recognized that definition of a seismically active tectonic fault is nothing but a trivial task. Special geological investigations shall be carried out for urban planning purposes and for important structures. An absence of movement during the late Quaternary (last 10 000 years) may be considered as an indication of non-active faults. Hopefully in Europe, surface offset caused by co-seismic fault rupture is a relatively rare event. For common structures one should refer to official documents issued by the competent national authorities to identify potentially dangerous active faults.



Fig. 4.4.1 Example of a fault disruption at Shih-Kang dam during the Chi-Chi earthquake in Taiwan (1999) (*Courtesy of Prof. Gazetas*)

4.5 Liquefaction assessment

Liquefaction designates the generic term for the loss of shear strength of cohesionless soils due to excess pore water pressure caused by cyclic, but not exclusively, loading. In almost all significant earthquakes that occurred, liquefaction has been observed and caused a lot of damages to infrastructures, buildings (Figure 4.5.1), pipelines, etc. This phenomenon has been extensively studied since 1964 and the state of the art is now well established and, more importantly, allows reliable prediction of the occurrence of liquefaction. Therefore this aspect is fully covered in EN 1998-5 with, furthermore, a normative annex for the use of SPT measurements for the evaluation of the undrained cyclic strength of cohesionless soils. However, aside the SPTs, other techniques are allowed for the determination of the soil strength like CPTs and shear wave velocity measurements. Laboratory tests are not recommended because obtaining reliable estimates of the liquefaction resistance requires very specialized drilling and sampling techniques which are beyond the budget of any common project. It is worth noting, because it often leads to a misinterpretation of the code, that although Annex B covering the evaluation of the liquefaction resistance of soils with SPT measurements is normative, it is by no way implied that liquefaction should be assessed with SPTs; annex B is only normative when SPTs are used and any of the other techniques mentioned above is allowed.

The verification of the liquefaction susceptibility shall be carried out under free field conditions but with the conditions prevailing during the lifetime of the building; for instance if a several meters high platform is erected to prevent flooding of the site, or if permanent water table lowering is implemented these features should be reflected in the evaluation. The recommended analysis is a total stress analysis in which the seismic demand, represented by the earthquake induced stresses, is compared to the seismic capacity, i.e. the undrained cyclic shear strength of the soil (also called liquefaction resistance). The seismic demand is simply evaluated with the well-known Seed-Idriss formula which allows a rapid calculation of the induced stress with depth without resorting to a dynamic site response analysis. As mentioned previously, the liquefaction resistance can be estimated through empirical correlations with an index parameter which can be the SPT blow count, the point resistance measured in a static cone penetration test (CPT) or the shear wave velocity. Attention is drawn on the fact that all these methods shall be implemented with several corrections aiming at normalizing the

measured index parameter; these corrections bear on the overburden at the depth of measurements, the fine content of the soil, the effective energy delivered to the rods in SPTs.



Fig. 4.5.1 Example of damages to a building caused by liquefaction of the foundation soil

For a soil to be prone to liquefaction it is necessary that it presents certain characteristics that govern its strength and also that the seismic demand be large enough. Therefore, taking the opposite view, EN 1998-5 has defined soils that are not prone to liquefaction or for which liquefaction assessment is not required. The following conditions shall be met:

- o Low ground surface acceleration ($<0.15g$)
- o **And** either soils with a clay content larger than 20% and a plasticity index larger than 10%, or soils with a silt content higher than 35% and a corrected blow count measured in SPT larger than 20, or clean sands with a corrected blow count larger than 30.

In addition, assessment of liquefaction is not required for layers located deeper than 15m below the foundation elevation. It does not mean that those layers are not prone to liquefaction, although susceptibility to liquefaction decreases with depth, but that because of their depth possible liquefaction of the layer will not affect the building. Obviously this condition is not sufficient by itself and should be complemented with a condition on the relative foundation dimensions with respect to the layer depth. Unfortunately, this clause does not exist in EN 1998-5.

Figure 4.5.2 taken from the normative annex B presents the correlation between the liquefaction resistance and the corrected SPT blow count $(N_1)_{60}$. These charts are valid for earthquake with magnitudes equal to 7.5. For other magnitudes correction factors are provided in the annex. The procedure is then rather simple: SPTs are carried out on site; raw blow counts are corrected to account for the overburden, delivered energy, fine content to yield the corrected value $(N_1)_{60}$. The liquefaction resistance is read from the charts and the correction for earthquake magnitude (multiplication factor) applied to provide the in situ liquefaction resistance. This resistance is compared to the seismic demand (calculated with the Seed-Idriss formula) and the safety factor computed. The minimum required safety factor is a NDP, but the recommended value is equal to 1.25.

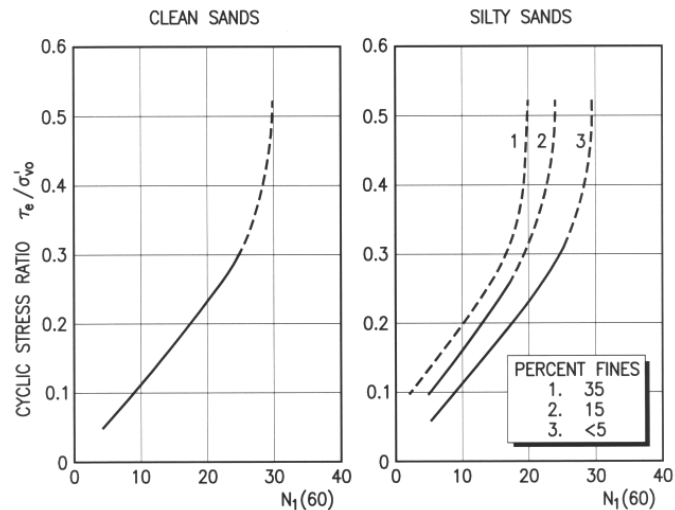

Fig. 4.5.2 Charts giving the liquefaction resistance as function of the corrected blow count for earthquake magnitude 7.5

4.6 Slope stability analyses

The ultimate limit state (ULS) or damage limit state (DLS) is related to unacceptable large displacements of the slope that may endanger the functionality or stability of the construction (Figure 4.6.2). Therefore analysis is required for all structures, except those of importance category I, that are located in the vicinity of a slope. The recommended approach is a pseudo-static stability analysis in which the inertia forces are represented by permanent horizontal and vertical loads related to the peak ground acceleration, $a_g S$. This peak ground acceleration shall be multiplied by the topographic amplification factor, τ , defined in annex A (informative) and which values are depicted in Figure 4.6.1.

Topographic amplification factors (ST)			
Type of topographic profile	Sketch	Average slope angle, α	ST
Isolated cliff and slope		$> 15^\circ$	1.2
Ridge with crest width significantly less than base width		15° to 30°	1.2
		$> 30^\circ$	1.4

Fig. 4.6.1 Topographic amplification factor

The inertia forces are defined by the following equations:

$$F_H = 0.5 a_g S \tau \left(\frac{W}{g} \right) \quad , \quad F_V = 0.33 \text{ to } 0.5 F_H \quad (4.3)$$

The key parameter in the pseudo-static approach is the choice of the fraction of the seismic coefficient ($k_H = a_g S/g$) that is applied to the soil weight (W). This fraction, set equal to 0.5 in EN 1998-5 (eq. (4.3)), has been selected on empirical basis, on observed performance of slopes and embankments during earthquakes and on back-calculations. It must be realized that choosing a seismic coefficient that represents only a fraction of the maximum ground acceleration implicitly implies that permanent displacements will occur during the earthquake; however, on the basis of tests examples, it is believed that, pending the limitations listed below, those displacements will remain limited and will not affect the stability of the slope. Would the designer have to design a sensitive structure at the crest of a slope for instance, although this situation is certainly not advisable, he may take the decision of limiting the induced permanent displacements with the choice of a higher seismic coefficient, possibly equal to the peak ground acceleration.

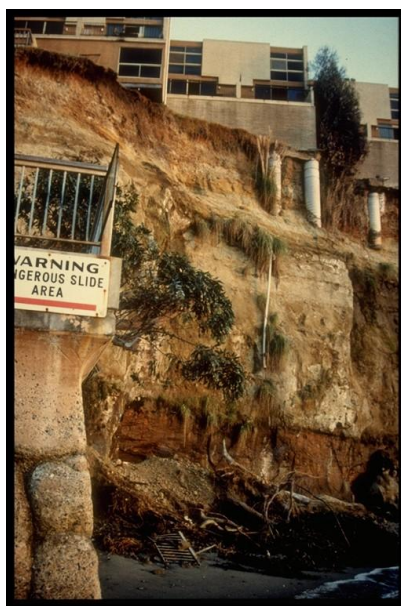

Fig. 4.6.2 Example of slope instability affecting constructions (Loma Prieta, 1989)

It is essential to keep in mind that the proposed calculation method is only valid if the soils composing the slope do not experience a significant loss of strength during seismic loading. This loss of strength may be caused, for saturated materials, by the excess pore water pressure build-up, even without reaching a state of liquefaction. Sensitive clays may also be subject to a sudden drop in strength when they are strained beyond a given strain threshold.

4.7 Earth retaining structures

Implicit in the design of a retaining structure is the fact that permanent displacements and tilting may be acceptable provided functional or aesthetic requirements are not violated. Permanent displacements, albeit of limited extent, always occur in the so-called yielding walls, i.e. walls that can move a sufficient amount to develop active earth pressure states. Examination of the behavior of retaining structures during earthquakes clearly shows that the most commonly observed failure mode is associated with liquefaction of the backfill supported by the wall (Figure 4.7.1). Therefore significant

pore water pressure build-up must absolutely be prevented and a minimum safety factor against liquefaction, specified equal to 2.0 in EN 1998-5, must be ensured.



Fig. 4.7.1 Example of soil liquefaction behind a retaining structure (Kobe, 1995)

As requested in EN 1998-5 the method of analysis should account for the inertial and interaction effects between the structure and the soil, and for the hydrodynamic effects in the presence of water. Provided the soil does not suffer from a significant loss of strength during seismic loading, the recommended approach is a pseudo-static analysis in which the earth pressures are calculated on the basis of Mononobe-Okabe formula. This approach is detailed in annex E which differentiates between dry soils, pervious saturated soil below the water table and impervious soils below the water table. The total action effects on the wall includes the static and seismic earth pressures, the hydrostatic and hydrodynamic water pressures and the inertial forces developed in the wall. The global force acting on the wall can be written as:

$$E_d = \frac{1}{2} \gamma^* (1 \pm k_v) K H^2 + E_{ws} + E_{wd} \quad (4.4)$$

where :

- o H is the wall height,
- o E_{ws} and E_{wd} are the static and hydrodynamic water pressures, occurring in the backfill or on the front face of the wall (for harbor structures),
- o k_v is the vertical seismic coefficient,
- o K the earth pressure coefficient, including both the effect of the static and seismic pressures,
- o γ^* the appropriate soil unit weight detailed below.

Both K and γ^* depend on the soil permeability.

The calculation model for the earth pressure is an extension of the static Coulomb model in which the seismic forces are introduced through horizontal and vertical forces (Figure 4.7.2); the pseudo-static soil thrust is obtained through equilibrium of the forces acting on the soil wedge. As for slope stability, the key parameter in the calculation of the earth pressure coefficient K is the choice of the seismic coefficient k_H . This one is related to the peak ground acceleration through:

$$k_H = \frac{1}{r} \frac{a_g S}{g} \quad , \quad k_V = \pm 0.33 \text{ to } 0.50 k_H \quad (4.5)$$

A r value larger than 1.0 implicitly implies that permanent movements are accepted for the wall. Accordingly, depending on the amount of displacement tolerated for the wall, r takes the values given in Table 4.7.1.

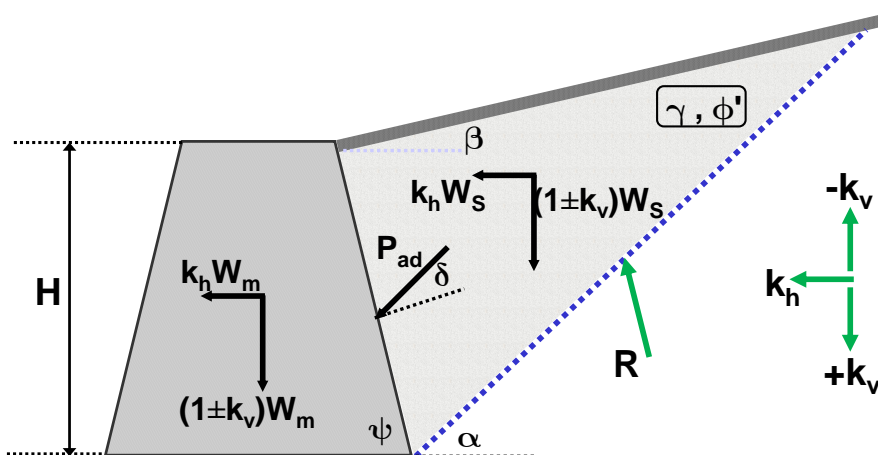

Fig. 4.7.2 Calculation model for the evaluation of the seismic earth pressures

Table 4.7.1 Coefficient relating the seismic coefficient to the amount of accepted wall displacement

Type of retaining structure	r
Free gravity walls that can accept a displacement $d_r < 300$ (mm) $a_g \gamma g S$	2
As above with $d_r < 200 a_g \gamma g S$ (mm)	1,5
Flexural reinforced concrete walls, anchored or braced walls, reinforced concrete walls founded on vertical piles, restrained basement walls and bridge abutments	1

As mentioned above the earth pressure coefficient K and the soil unit weight γ^* to consider in eqn. 4.4 depend on the soil permeability.

For unsaturated soils above the water table the unit weight is simply the soil unit weight γ and the angle θ entering the expression of Mononobe-Okabe formula (see EN 1998-5, annex E) is given by

$$\tan(\theta) = \frac{k_H}{1 \pm k_V} \quad (4.6)$$

The water pressures E_{ws} and E_{wd} are obviously equal to 0.

For highly pervious saturated soils below the water table (permeability typically higher than $5 \cdot 10^3 \text{ m/s}$) the soil unit weight is the buoyant unit weight γ' and θ is given by:

$$\gamma^* = \gamma' = \gamma - \gamma_w \quad , \quad \tan(\theta) = \frac{\gamma_d}{\gamma'} \frac{k_H}{1 \pm k_v} \quad (4.7)$$

where γ_d is the soil dry unit weight. The water pressures E_{ws} and E_{wd} are non-zero. In particular, the hydrodynamic water pressure is computed according to Westergaard's formula giving the hydrodynamic pressure acting on a rigid wall moving against an infinite water reservoir:

$$E_{wd} = \frac{7}{12} k_H \gamma_w H_w^2 \quad (4.8)$$

For impervious saturated soils below the water table (permeability typically smaller than $5 \cdot 10^{-4} \text{ m/s}$) the soil unit weight is the buoyant unit weight γ' and θ is given by:

$$\gamma^* = \gamma' = \gamma - \gamma_w \quad , \quad \tan(\theta) = \frac{\gamma}{\gamma'} \frac{k_H}{1 \pm k_v} \quad (4.9)$$

where γ is the soil total unit weight. The water pressure E_{ws} is non-zero but the hydrodynamic water pressure E_{wd} is equal to zero.

The rationale for the above distinction between highly pervious and impervious soils is based on the theoretical analysis by Matsuo and O'Hara of the excess pore water pressure generated in a two-phase medium during cyclic loading (Figure 4.7.3)

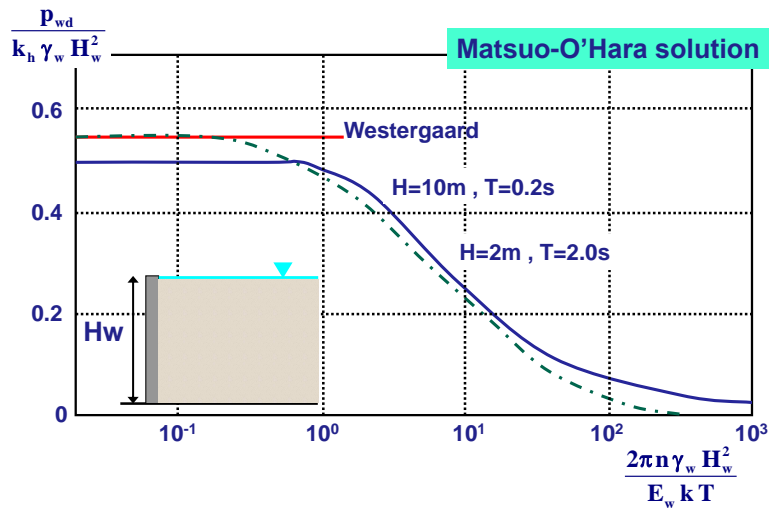

Fig. 4.7.3 Theoretical hydrodynamic excess pore pressure in a saturated two-phase medium

As shown in Figure 4.7.3, as the soil permeability k tends to infinity the excess hydrodynamic water pressure p_{wd} approaches, as expected, Westergaard's solution, while as the permeability tends to zero the excess hydrodynamic water pressure becomes negligible. It does not mean, however, that the presence of water does not affect the actions transmitted by the soil to the structure; simply in the case of an impervious material the soil skeleton and the water contained in it move in phase and behave as a one-phase medium. Comparison of eqn. (4.9) with eqn. (4.6) shows that the seismic coefficient (not the earth pressure coefficient K) is multiplied by a factor almost equal to 2 with respect to the dry soil.

The dynamic increment of the earth pressure is assumed to act at mid-height of the wall except for walls that are susceptible to rotate around their toe or for flexible retaining structures, like anchored sheet pile walls. As calculations, as well as post-earthquake observations, have shown that the slope of the potential failure wedge is flatter than under static condition, the length of the anchor shall be increased with respect to the length computed under static conditions to ensure that the anchor system is located outside this potential failure wedge; the recommended length is given by:

$$L = L_S \left[1 + 1.5 \frac{a_g S}{g} \right] \quad (4.10)$$

where L_S is the anchor length calculated under static conditions. Furthermore, the anchorage tendon shall have the capability of accommodating differential soil displacements that are likely to develop between the front wall and the anchor wall. These differential displacements are caused by a phenomenon similar to topographic amplification close to the front wall.

Verifications of the wall include checks on the sliding capacity, loss of bearing capacity, general slope failure and structural strength verifications.

4.8 Foundation systems

Foundations shall ensure the transfer of forces from the superstructure to the soil without significant deformation. Deformations shall remain small because foundations are placed below the ground and they are difficult to inspect and repair after an earthquake. Furthermore, inelastic deformations of soils and foundations are difficult to accurately predict, although it is recognized that they are a significant source of energy dissipation.

The design action effects shall be evaluated in accordance with the design of the superstructure:

- o For dissipative structures, as defined in EN 1998-1, they are evaluated according to capacity design considerations;
- o For non-dissipative structures the actions effects are simply obtained from the elastic analysis.

4.8.1 DIRECT FOUNDATIONS: FOOTING, RAFT

The design verifications include verification with respect to the sliding capacity and verification for the seismic bearing capacity.

4.8.1.1 Sliding capacity

The total design horizontal force shall satisfy the following condition:

$$V_{SD} \leq F_{H1} + F_{H2} + 0.3F_B \quad (4.11)$$

Where:

- o F_{H1} : Friction along the base of the footing, equal to $N_{SD} \tan(\delta)/\gamma_M$;
- o F_{H2} : Friction along lateral sides for embedded foundations;
- o F_B : Ultimate passive resistance.

- o N_{SD} : Vertical design force acting on the foundation
- o δ : Friction angle between the foundation and the soil
- o γ_M : partial factor taken equal to γ_ϕ

It is worth noting that although full friction on the base and lateral sides of the foundation can be mobilized, it is not allowed to rely on more than 30% of the total passive resistance. The rationale for this limitation is that mobilization of full passive resistance requires a significant amount of displacement to take place, and this does not comply with the performance goal set forth at the beginning of this paragraph. However, under certain circumstances, sliding may be accepted because it is an effective means for dissipation of energy and, furthermore, numerical simulations generally show that the amount of sliding is limited. For this situation to be acceptable the ground characteristics shall remain unaltered during seismic loading and sliding shall not affect the functionality of lifelines. Since soil under the water table may be prone to pore pressure build-up, which will affect their shear strength, sliding is only tolerated when the foundation is located above the water table. The second condition listed above is simply recognition that buildings are not isolated structures and are connected to lifelines; one should make sure that displacements imposed by buildings to lifelines will not damage either the connection or the lifelines themselves. For instance, during the Loma Prieta earthquake (1989), liquefaction in the Marina district caused severe lateral spreading that did not really damage the houses but induced failure of the gas pipelines.

4.8.1.2 Bearing capacity

The seismic bearing capacity of foundations shall be checked taking into consideration the load inclination and eccentricity acting on the foundation, as well as the effect of the inertia forces developed in the soil medium by the passage of the seismic waves. A general expression has been provided in annex F (informative) that has been derived from theoretical limit analyses of a strip footing. However, recent studies have shown that the same expression is still valid for a circular footing provided the ultimate vertical force under vertical centered load, N_{max} , entering eqn. (4.12) is computed for a circular footing. The condition to satisfy for the foundation to be safe against bearing capacity failure simply expresses that the forces N_{SD} (design vertical force), V_{SD} (design horizontal force), M_{SD} (design overturning moment) and \bar{F} (soil seismic forces) should lie within the surface depicted in Figure 4.8.1.

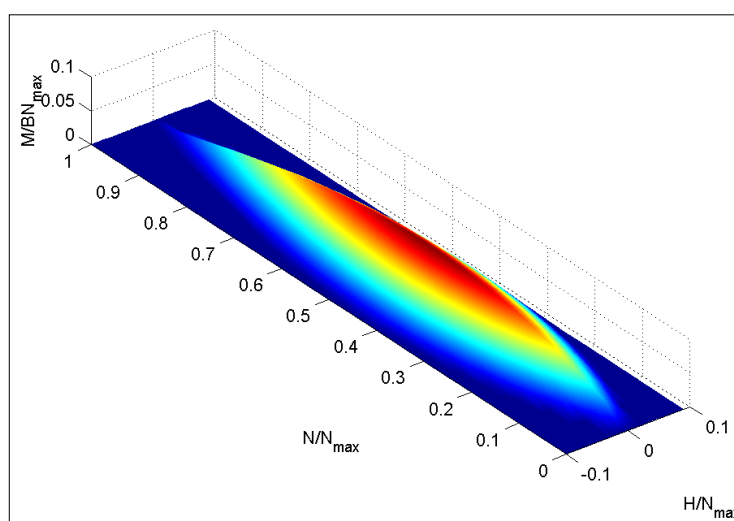

Fig. 4.8.1 Surface of ultimate loads for the foundation bearing capacity

The analytical expression of the surface is provided in annex F:

$$\frac{(1-e\bar{F})^{c_T} (\beta\bar{V})^{c_T}}{(\bar{N})^a \left[(1-m\bar{F}^k)^{k'} - \bar{N} \right]^b} + \frac{(1-f\bar{F})^{c_M} (\gamma\bar{M})^{c_M}}{(\bar{N})^c \left[(1-m\bar{F}^k)^{k'} - \bar{N} \right]^d} - 1 \leq 0 \quad (4.12)$$

with the following definition for the different quantities:

$$\bar{N} = \frac{\gamma_{RD} N_{sd}}{N_{max}}, \quad \bar{V} = \frac{\gamma_{RD} V_{sd}}{N_{max}}, \quad \bar{M} = \frac{\gamma_{RD} M_{sd}}{B N_{max}}, \quad \bar{F} = \left\{ \begin{array}{l} \frac{\gamma_{RD} \rho a B}{C_u} \\ \frac{\gamma_{RD} a}{g \tan \phi} \end{array} \right\} \quad (4.13)$$

The coefficients represented by lower case letters in eqn. 4.12 (like a, b, \dots) are numerical values that are tabulated in annex F.

Although Eqn. 4.12 does not look familiar to geotechnical engineers who are more accustomed to the "classical" bearing capacity formula with correction factors for load inclination and eccentricity, it reflects the same aspect of foundation behavior. The verification suggested in EN 1998-5 is similar to using interaction diagrams in structural engineering for the design check of a beam cross section under combined axial force and bending moment.

The model factor γ_{RD} , which only appears in EN 1998-5 for the seismic verification of the bearing capacity, is introduced to reflect the uncertainties in the theoretical model, and as such should be larger than 1.0, but also to recognize that limited permanent foundation displacements may be tolerated (i.e. Eqn. (4.12) is violated), in which instance it can be smaller than 1.0. Tentative values, which intend to combine both effects, are proposed in annex F and recalled in Table 4.8.1 which reflects that for the most sensitive soils (loose saturated soils) the model factor should be higher than for stable soils (medium dense sand).

Table 4.8.1 Model factors for use in eqn.(4.13)

Medium dense sand	Loose dry sand	Loose saturated sand	Non sensitive clay	Sensitive clay
1.0	1.15	1.50	1.0	1.15

4.8.1.3 Example of bearing capacity check

This example is taken from the design example covered in the book. The building has been designed according to capacity design considerations. Therefore clause 5.3.1 of EN 1998-5 applies: *"The action effect for the foundations shall be based on capacity design considerations accounting for the development of possible overstrength"*.

Clause 4.4.2.6 of EN 1998-1 provides the design values of the action effect on the foundation:

$$E_{Fd} = E_{F,G} + \gamma_{Rd} \Omega E_{F,E} \quad (4.14)$$

- o γ_{Rd} is the overstrength factor equal to 1.0 for a behavior factor q less or equal 3, and equal to 1.2 otherwise;
- o $\Omega = R_{di} / E_{di} \leq q$ with R_{di} the design resistance and E_{di} the design value of the action effect in seismic situation;
- o $E_{F,G}$ is the action effect of the permanent loads,
- o $E_{F,E}$ is the action effect of the seismic loads,

Table 4.8.2 gives the values of E_{Fd} for column 7 of the design example. For these quantities the product $\Omega \gamma_{Rd}$ takes the value:

$$\Omega \gamma_{Rd} = q = 3 \tag{4.15}$$

Table 4.8.2 Design action effects E_{Fd} for the foundation of column 7 of the design example

	N	My	Vy	Mz	Vz	V	M
	(kN)	(kN.m)	(kN)	(kN.m)	(kN)	(kN)	(kN.m)
+X/+Y/max	2861	21	9	27	11	14	34
-X/+Y/max	2861	26	12	27	11	16	37
+X/-Y/max	2861	21	9	28	11	14	35
-X/-Y/max	2861	26	12	28	11	16	38
+X/+Y/min	2744	21	9	27	11	14	34
-X/+Y/min	2744	26	12	27	11	16	37
+X/-Y/min	2744	21	9	28	11	14	35
-X/-Y/min	2744	26	12	28	11	16	38

The footing has been sized to ensure a safe bearing capacity under permanent loads; its calculated dimensions are equal to 2m x 2m. The soil conditions correspond to stiff clay classified as ground type B (Table 3.1 of EN 1998-1).

For static conditions, the undrained shear strength of the clay is assumed equal to $C_u = 300\text{kPa}$. For seismic conditions, a 10% reduction is assumed to reflect a small cyclic degradation under cyclic loading (clause 3.1 of EN 1998-5) and the relevant cyclic undrained shear strength is $C_u = 270\text{kPa}$. With a material factor of 1.4 (clause 3.1 of EN 1998-5), the design undrained cyclic strength becomes equal to $C_u = 195\text{kPa}$. Finally, according to annex F of EN 1998-5 (see also Table 4.8.1) the model factor $\gamma_{RD} = 1.0$.

As mentioned previously, although annex F is for strip footing, it can also be used for circular footing with the appropriate choice of N_{max} . The equivalent foundation radius is 1.13m and

$$N_{max} = \pi r^2 N_c C_{ud} = 3.14 \times 1.13^2 \times 6.0 \times 195 = 4680\text{kN} \tag{4.16}$$

Then from eqn. (4.13):

$$\bar{N} = \frac{2861 \text{ or } 2744}{4680} = 0.61 \text{ or } 0.59 \quad , \quad \bar{V} = \frac{16}{4680} = 0.0035$$

$$\bar{M} = \frac{38}{2 \times 4680} = 0.0041 \quad , \quad \bar{F} = \frac{2 \times 2.5 \times 2.0}{195} = 0.05 \quad (4.17)$$

The quantity on the left hand side of eqn. (4.12) is equal to -0.999 and therefore stability is ensured; the large margin safety is due to the small overturning moment applied to the foundation. Figure 4.8.2 presents a cross section of the surface of ultimate loads depicted in Figure 4.8.1 with the location of the point corresponding to the actual forces acting on the foundation. This point is located well inside the surface of ultimate loads.

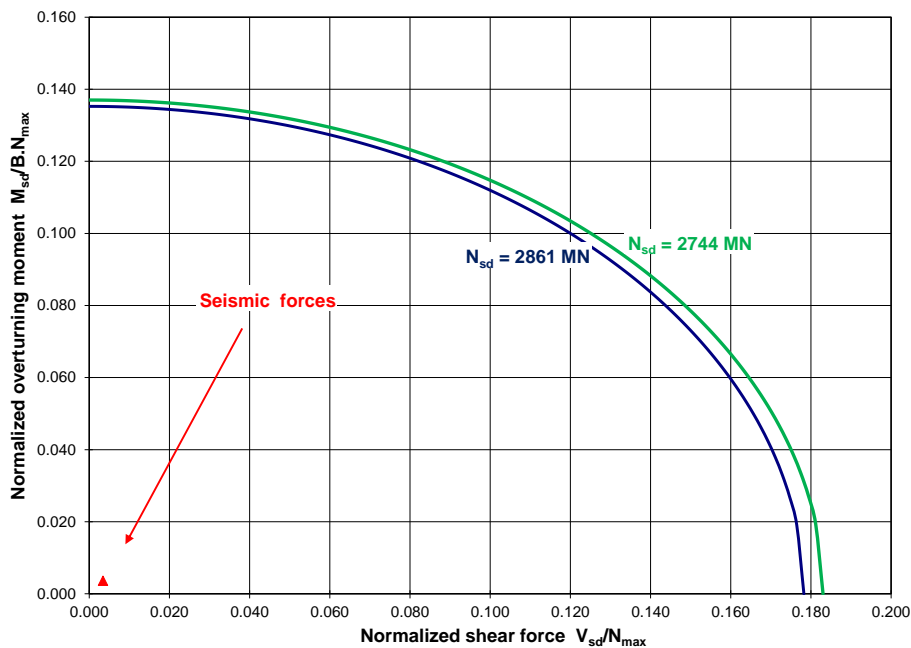

Fig. 4.8.2 Verification of the seismic bearing capacity of column 7 footing

4.8.2 PILES AND PIERS

Piles and piers need to be verified under the effects of the inertia forces transmitted from the superstructure onto the pile heads and also under the effects of kinematic forces due to the earthquake-induced soil deformations. However, kinematic interaction needs only to be considered for soft deposits (ground types D, S₁ or S₂) with consecutive layers of sharply contrasting stiffness, design acceleration in excess of 0.10g and supported structure of importance category III and IV.

Although piles will generally be designed to remain elastic, they may under certain conditions be allowed to develop plastic hinges at their head. The reason to require that piles remain elastic is, once again, related to the difficulty to inspect and repair piles after an earthquake. Nevertheless, it is well known by designers that large bending moments may develop at the pile-cap connection (see Figure 4.8.3) and designing that section to remain elastic may be a formidable task.



Fig. 4.8.3 Example of damage at the pile-cap connection

It is therefore more economical and often safer to design this section with a plastic hinge, applying all the requirements listed in EN 1998-1 for plastic hinges.

Among the special provisions that are required for piles, the least accepted by the earthquake community is clause 5.4.2(5) of EN 1998-5: "*Inclined piles are not recommended for transmitting lateral loads to the soil*". In fact, this clause has been added for several reasons:

- o There are several examples of poor behavior of inclined piles during earthquakes; it is, however, admitted that this is not a general observation since there exist counter examples, especially in situations where soil lateral spreading is significant (Landing Road Bridge during the 1987 Edgcombe earthquake in new Zealand);
- o Piles working in compression/tension are less ductile than flexural piles;
- o Inclined piles are highly sensitive to soil settlements which may induce residual bending moments in the piles as pointed out in the same clause "*If inclined piles are used they should be designed to safely carry axial loads as well as bending loads*".

Figure 4.8.4 shows the results of centrifuge tests carried out at IFSTTAR (former LCPC) on groups of vertical and inclined piles. As seen from the figure residual bending moments are significantly higher in the inclined pile (red curve) than in the vertical one (blue curve) regardless of the frequency of the sine input signal; these bending moments are explained by the soil settlement beneath the inclined pile that reduces the supporting soil reaction.

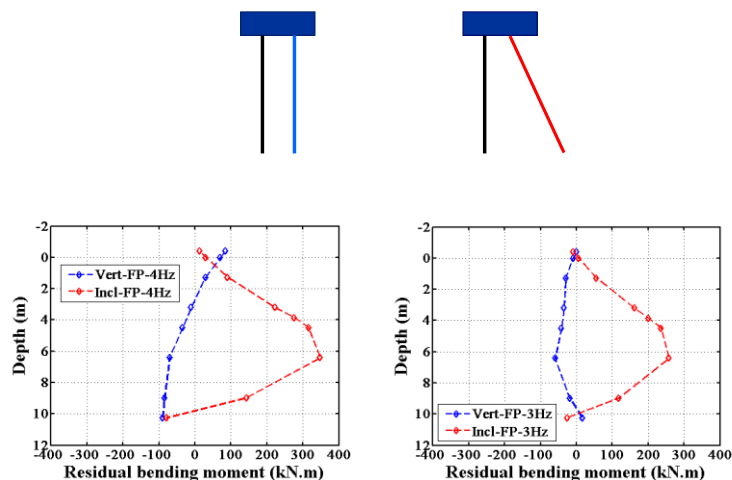

Fig. 4.8.4 Residual bending moment in inclined and vertical piles groups; centrifuge tests carried out at IFSTTAR

4.9 Soil Structure Interaction

The chapter on soil structure interaction (SSI) is mainly qualitative because it has been realized, when drafting EN 1998-5, that being more specific was impossible, unless the chapter becomes a textbook. Therefore, the effects of SSI are simply described in an annex (annex D) and situations where SSI shall be considered in design are identified. They concern massive and embedded foundations, slender structures like towers, masts and chimneys, more generally any structure sensitive to second order effect ($P-\delta$ effects), structures founded on soft soil deposits with a V_{S30} less than 100m/s, and piled foundations. For piled foundations, an informative annex (annex C) provides the pile head stiffness that can be used for SSI calculations.

As a result of SSI, the seismic response of a structure is modified with respect to the case of a fixed-base structure. Due to the flexibility of the ground the fundamental period of vibration is elongated, significant rocking movements may take place and the overall damping of the system is increased due to radiation damping. For the majority of structures, except those listed above, these effects tend to be beneficial because they reduce the seismic forces; however, the importance of rocking motions must not be overlooked. An illustrative example is shown in Figure 4.9.1. This picture was taken in Mexico City after the 1985 Michoacán Guerrero earthquake; two adjacent buildings of the same original height experienced severe rocking movements because of the very low stiffness of the Mexico lake deposits; the separation joint between the buildings was too small and pounding eventually occurred causing a structural failure with the loss of three stories in left building. Without SSI, i.e. if the buildings have been founded on rock, the rocking movements would have been negligible and the buildings may have survived the earthquake.



Fig. 4.9.1 Pounding of adjacent buildings in Mexico City (1985) due to SSI

CHAPTER 5

Specific rules for the design and detailing of steel buildings:

(i) Steel moment resisting frames

A. Plumier

University of Liege

5.1 Definition of the structure

The example consists in a preliminary design of the building shown at Figure 5.1.1. The aim is to obtain in a straightforward way, making certain approximations, 'sizes' for the structural elements close to a final design. Such a preliminary process is a normal step in seismic design, because the dynamic action effects are a function of the member stiffness which the designer is trying to determine, so iterations are inevitable. A more refined definition of the section sizes, complete 3D calculations etc, can only be made once the 'reasonable' design presented hereafter has proved its validity.

The example considers a building in which the seismic resistance is provided by both peripheral and interior moment resisting frames (MRF), in both the x and y directions. MRFs are known to be flexible structures and their design is often governed by the need to satisfy deformation criteria under service earthquake loading, or limitation of $P-\Delta$ effects under design earthquake loading. For this reason, rigid connections are preferred.

It is wise in a preliminary design to select sections that will satisfy, with some reserve, the design criteria under gravity loading alone, and to select a value below the maximum authorised one for the behaviour factor q .

The maximum allowed is $q = 5 \times \alpha_u / \alpha_1 = 5 \times 1.3 = 6.5$.

In order to quickly arrive at the final design a value of $q = 4$ will be chosen for the analysis.

The preliminary design consists of:

- o Firstly define minimum beam sections, checking deflection and resistance criteria under gravity loading.
- o Then follow an iterative process, going through the following steps until all design criteria are fulfilled.

The iterative process can make use of either the 'lateral force' method or the 'spectral response-modal superposition' method. If the 'lateral force' method is used, the calculation steps are:

1. selection of beam sections
2. definition of column sections checking the 'Weak Beam Strong Column' criteria
3. check compression/buckling resistance of columns at ground floor level under gravity loading
4. calculation of the seismic mass ($G + \psi_{E1} Q$) of the structure
5. evaluation of the period of the structure by means of a code formula
6. evaluation of the resultant base shear F_b and distribution of F_b into lateral forces
7. static analysis of one plane frame under 'lateral loads', magnified by a factor to take into account torsional effects
8. static analysis under gravity loading ($G + \psi_{21} Q$)
9. stability check, considering $P-\Delta$ effects (parameter θ) in the seismic loading situation (in which the gravity loading is $G + \psi_{21} Q$)
10. deflection check under 'service' earthquake loading (a fraction of the design earthquake, generally 0.5)
11. combination of action effects determined in steps 7. and 8., and design checks on section resistances.

If the 'spectral response-modal superposition' method is used, steps 5., 6. and 7. are replaced by:

5. 'spectral response-modal superposition' analysis of one plane frame to evaluate the earthquake action effects. Torsional effects are included by magnifying the design spectrum by the amplification factor δ .

The 'spectral response-modal superposition' method is a dynamic analysis which allows several vibration modes to be taken into account.

Both the 'lateral force' and the 'spectral response-modal superposition' methods are used below in order to compare the results of those methods in terms of fundamental period and base shear.

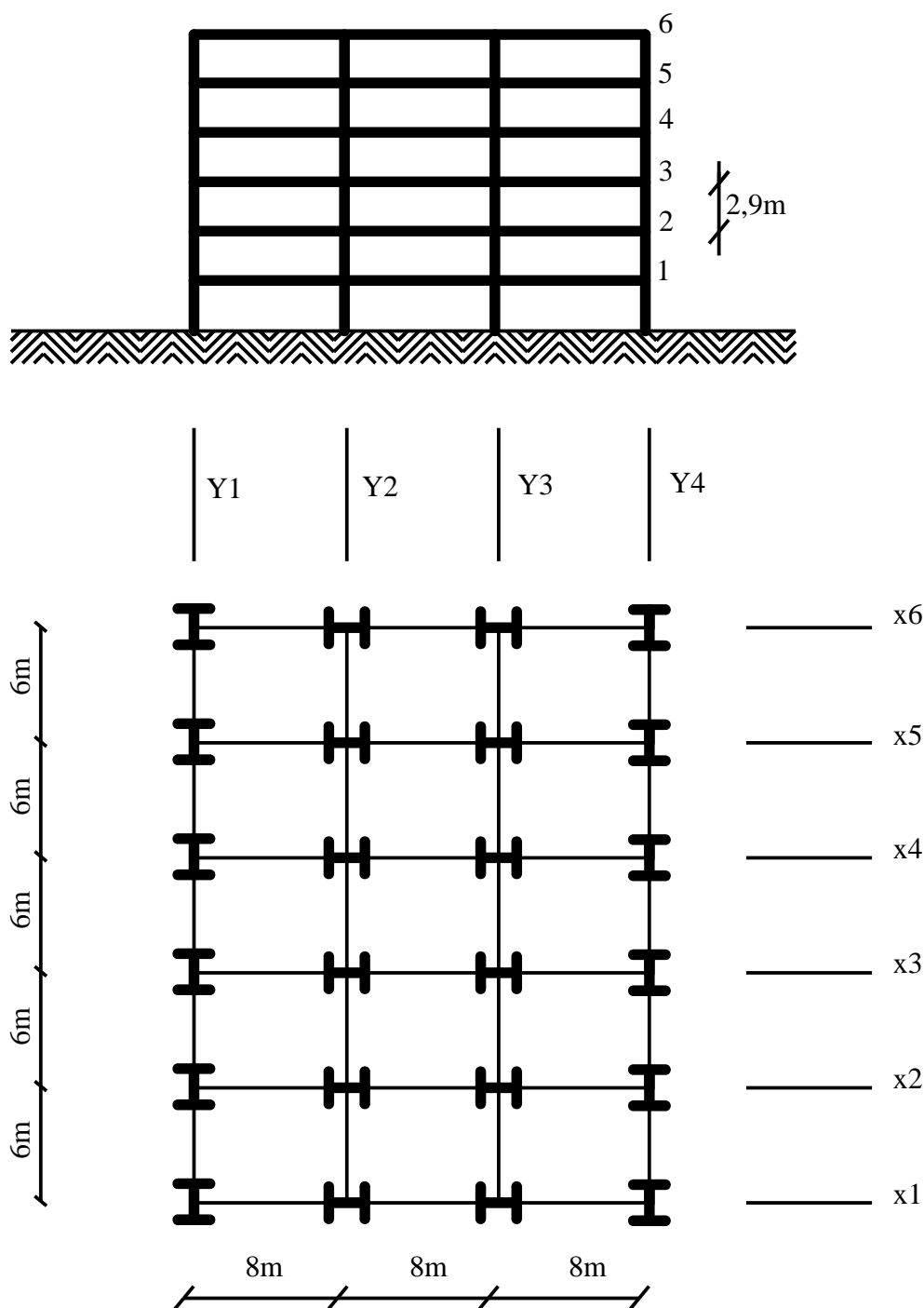

Fig. 5.1.1 Definition of the structure.

The site and building data are as follows:

- o Seismic zone ; $a_{gR} = 2.0 \text{ m/s}^2$
- o Importance of the building; office building, $\gamma_I = 1.0 \Rightarrow a_g = 2.0 \text{ m/s}^2$
- o Service load $Q = 3 \text{ kN/m}^2$
- o Design spectrum; type 1
- o Soil B \Rightarrow from code: $S = 1.2$ $T_B = 0.15\text{s}$ $T_C = 0.5\text{s}$ $T_D = 2\text{s}$
- o Behaviour factor: $q = 4$

The building dimensions are shown in Figure 5.1.1. The orientation of the columns is chosen in order to have:

- o a similar percentage of strong and weak axis column bending in both the x and y directions.
- o columns presenting their strong axis where this is mostly needed in order to satisfy the 'weak beam-strong column' condition with respect to the deepest beams used in the structure, that is for the beams in the x direction (longer spans) at interior nodes.

5.2 Checks of resistance and stiffness of beams

Beams in x direction. Deflection check.

Beams are assumed to be fixed at both ends. Span $l = 8\text{m}$.

Frame on line X2 supports a width of floor = 6m

Floor weight is estimated at 5 kN/m^2 , all included.

G floor : $6\text{m} \times 5 \text{ kN/m}^2 = 30 \text{ kN/m}$

G walls : 3 kN/m

Q service : $6\text{m} \times 3 \text{ kN/m}^2 = 18 \text{ kN/m}$

$G + Q = 30 + 3 + 18 = 51 \text{ kN/m}$

Deflection limit: $f = l/300$ under $G+Q = 51 \text{ kN/m}$

$f = pl^4 / 384EI = l/300$

$\Rightarrow I_{\text{required}} = 300 pl^3 / 384E = (300 \times 51 \times 8^3) / (384 \times 0.2 \times 10^9) = 10199.10^4 \text{ mm}^4$

Minimum beam section in x direction: IPE 330 ($I = 11770.10^4 \text{ mm}^4$)

Beams in x direction. Moment resistance check.

$1.35G + 1.5Q = 1.35 \times 33 + 1.5 \times 18 = 71.55 \text{ kN/m}$

Beams are assumed fixed at both ends: $M_{\text{Sd}} = 71.55 \times 8^2 / 12 = 381 \text{ kNm}$

$W_{\text{pl,min}} = 381.10^6 / 355 = 1075.10^3 \text{ mm}^3$

Minimum beam section in x direction: IPE 400 ($W_{\text{pl}} = 1307.10^3 \text{ mm}^3$)

Beams in y direction. Deflection check.

Beams are assumed fixed at both ends. Span $l = 6\text{m}$.

Frame on line Y2 supports a width of floor = 8m

G floor : $8\text{m} \times 5 \text{ kN/ m}^2 = 40 \text{ kN/ m}$

G walls : 3 kN/ m

Q service : $8\text{m} \times 3 \text{ kN/ m}^2 = 24 \text{ kN/ m}$

G + Q = 67 kN/m

Deflection limit: $l/300$ under G+Q = 67 kN/m

$$f = p^l / 384EI = l/300$$

$$\Rightarrow I_{\text{required}} = 300 p^3 / 384E = (300 \times 67 \times 6^3) / (384 \times 0.2 \times 10^9) = 5653.10^4 \text{ mm}^4$$

Minimum beam section in y direction: IPE 270 ($I = 5790.10^4 \text{ mm}^4$)

Beams in y direction. Moment resistance check

$$1.35G + 1.5Q = 1.35 \times 43 + 1.5 \times 24 = 58 + 36 = 94.05 \text{ kN/m}$$

Beams are assumed fixed at both ends: $M_{\text{Sd}} = 94.05 \times 6^2 / 12 = 282 \text{ kNm}$

$$W_{\text{pl,min}} = 282.10^6 / 355 = 795.10^3 \text{ mm}^3$$

Minimum beam section in y direction: IPE 360 ($W_{\text{pl}} = 1019.10^3 \text{ mm}^3$)

Conclusion.

For gravity loading, minimum beam sections are:

- in direction x : IPE400 $W_{\text{pl}} = 1307.10^3 \text{ mm}^3$ $I = 23130.10^4 \text{ mm}^4$

- in direction y : IPE360 $W_{\text{pl}} = 1019.10^3 \text{ mm}^3$ $I = 16270.10^4 \text{ mm}^4$

Based on these minimum sizes needed to resist gravity loading the iterative procedure for sizing the beams and columns can begin. The calculations presented below correspond to the following (slightly greater) sizes of beams and columns:

- beam sections in direction x : IPE500 $I = 48200.10^4 \text{ mm}^4$ $W_{\text{pl}} = 2194.10^3 \text{ mm}^3$

- beam sections in direction y : IPEA450 $I = 29760.10^4 \text{ mm}^4$ $W_{\text{pl}} = 1494.10^3 \text{ mm}^3$

- columns: HE340M: $I_{\text{strong axis}} = I_y = 76370.10^4 \text{ mm}^4$ $I_{\text{weakaxis}} = I_z = 19710.10^4 \text{ mm}^4$
 $W_{\text{pl, strong axis}} = 4718.10^3 \text{ mm}^3$ $W_{\text{pl, weakaxis}} = 1953.10^3 \text{ mm}^3$

5.3 ‘Weak Beam-Strong Column’ checks

The Weak Beam-Strong Column (WBSC) check is: $\sum M_{\text{Rc}} \geq 1.3 \sum M_{\text{Rb}}$

That criterion can be expressed: $\sum f_{\text{yd,column}} \times W_{\text{pl,column}} \geq 1.3 \sum f_{\text{yd,beams}} \times W_{\text{pl,beams}}$

Grade S355 steel is chosen for both the beams and columns, so the WBSC check becomes:

$$\sum W_{\text{pl,column}} \geq 1.3 \sum W_{\text{pl,beams}}$$

At interior nodes there are 2 beams and 2 columns intersecting, so the WBSC check becomes:

$$W_{pl, column} \geq 1.3 W_{pl, beam}$$

At exterior nodes, there is 1 beam and 2 columns intersecting so the WBSC check becomes:

$$2 W_{pl, column} \geq 1.3 W_{pl, beam}$$

Interior node, line Y2.

$$W_{pl, column, weak axis} \geq 1.3 W_{pl, IPEA450}$$

$$\Rightarrow \text{HE340M has } W_{pl, weakaxis} = 1953.10^3 \text{ mm}^3 > 1.3 \times 1494.10^3 = 1942.10^3 \text{ mm}^3$$

Exterior node line Y2.

$2W_{pl, column, weak axis} \geq 1.3 W_{pl, IPE360}$ is a less demanding check than that for the interior node, so is satisfied 'by inspection'.

Line Y1.

Columns are oriented such that the strong axis bending resistance of the HE340M sections is mobilised rather than the weak axis considered above, so the WBSC check is satisfied 'by inspection'.

Interior node, line X2.

$$W_{pl, HE340M, strong axis} = 4718.10^3 \text{ mm}^3$$

$$W_{pl, IPE500} \times 1.3 = 2194.10^3 \times 1.3 = 2852.10^3 \text{ mm}^3$$

$$4718.10^3 \text{ mm}^3 > 2852.10^3 \text{ mm}^3 \Rightarrow \text{WBSC condition satisfied.}$$

Exterior node, line X2.

$$\text{WBSC condition: } 2W_{pl, column, weak axis} \geq 1.3 W_{pl, IPE500}$$

$$2 W_{pl, HE340M, weak axis} = 1953 \times 2 = 3906.10^3 \text{ mm}^3 > 1.3 W_{pl, IPE500} = 2194.10^3 \times 1.3 = 2852.10^3 \text{ mm}^3$$

WBSC condition satisfied.

Conclusion.

Beam sections IPE500 in direction x and IPEA450 in direction y satisfy the WBSC condition when HE340M columns are used and oriented as indicated in Figure 5.1.1.

5.4 Interior column. Axial compression check

Relevant loaded area: $8 \times 6 = 48 \text{ m}^2$

Floor weight is 5 kN/m^2 , all included.

G floor = $48 \times 5 = 240 \text{ kN/storey}$

G walls = $(8 + 6) \times 3 = 42 \text{ kN/storey}$

G frame: 18.5 kN/storey

$$Q = 3 \text{ kN/m}^2 \times 48 = 144 \text{ kN}$$

$$1.35 G + 1.5 Q = 1.35 \times 300.5 + 1.5 \times 144 = 622 \text{ kN/storey}$$

$$\text{Compression in column at basement level: } 6 \times 622 = 3732 \text{ kN}$$

Approximate buckling length: 2.9 m (equal to the storey height)

$$\text{Slenderness (with HE340M section, weak axis, } i = 79\text{mm): } 2900/79 = 36.7$$

$$\text{Euler slenderness } \lambda_E : 76.4 \text{ (S355 steel)} \Rightarrow \text{reduced slenderness } \bar{\lambda} = 0.48 \Rightarrow \chi = 0.85$$

$$A_c = 31580 \text{ mm}^2$$

$$N_{b,Rd} = 0.85 \times 31580 \times 355 = 9529 \text{ kN} > 3732 \text{ kN}$$

5.5 Interior column. Plastic resistance at ground level

Plastic hinges form in the bases of the columns at ground level as part of the global plastic mechanism. Their bending resistance has to be evaluated considering the interaction between axial force and bending, according to Eurocode 3 (EN1993-1-1 paragraph 6.2.9.1), for the seismic design condition. The axial force is found as the sum of the contribution of 6 storeys:

$$N_{Ed} = G + \psi_{2i} Q = (300.5 + 0.15 \times 144) \times 6 = 1932 \text{ kN}$$

The value $\psi_{2i} = 0.3$ corresponds to offices.

$$\text{For the HE340M section: } N_{pl,Rd} = f_{yd} \times A = 355 \times 31580 = 11210 \cdot 10^3 \text{ N} = 11210 \text{ kN}$$

$$n = N_{Ed} / N_{pl,Rd} = 0.184$$

$$a = (A - 2bt_f) / A = (31580 - 2 \times 309 \times 40) / 31580 = 0.22 > 0.17 (= n)$$

$$M_{pl,y,Rd} = f_{yd} \times W_{pl,y,Rd} = 355 \times 4718 \cdot 10^3 = 1674.89 \cdot 10^6 \text{ Nmm} = 1674.89 \text{ kNm}$$

$$M_{N,y,Rd} = M_{pl,y,Rd} (1-n) / (1-0.5 a) = 1674.89 \cdot 10^6 \times (1-0.184) / (1-0.5 \times 0.22) = 1540 \cdot 10^6 \text{ Nmm}$$

$$M_{N,y,Rd} = 1540 \text{ kNm}$$

$$\text{As } n < a \Rightarrow M_{N,z,Rd} = M_{pl,z,Rd} = 355 \times 1953 \cdot 10^3 \text{ Nmm} = 693 \text{ kNm}$$

$M_{N,y,Rd} = 1540 \text{ kNm}$ and $M_{N,z,Rd} = 693 \text{ kNm}$ are the resisting moments. In section 5.10, it is checked that they are greater than the design action effects considered for elements checks.

5.6 Evaluation of the seismic mass

The unit used for mass is 'kg'. Total floor area for a single storey: $30 \times 24 = 720 \text{ m}^2$

$$G_{\text{floor}} = 500 \text{ kg/m}^2 \times 720 = 360\,000 \text{ kg /storey}$$

$$\text{Partitions and façade; total length for one storey: } 30\text{m} \times 4 + 24\text{m} \times 6 = 264 \text{ m}$$

$$300 \text{ kg/m} \Rightarrow 79200 \text{ kg / storey}$$

G_{roof} considers various pieces of equipment (elevator plant rooms, air conditioning, water tanks, etc) with an assumed mass of 79200 kg

G_{frame} : column HE340M: $2.9 \text{ m} \times 24 \times 248 \text{ Kg/m} = 17260 \text{ kg}$
 beams IPE500: $8 \text{ m} \times 3 \times 6 \times 90.7 \text{ Kg/m} = 13060 \text{ kg}$
 beams IPEA500: $30 \text{ m} \times 4 \times 67.2 \text{ Kg/m} = 8064 \text{ kg}$
 total G_{frame} : 38384 kg/storey

$\psi_{Ei} \times Q$ (service load) = $\psi_{Ei} \times 300 \text{ kg/m}^2 \times 720 \text{ m}^2 = 0.15 \times 300 \times 720 = 32400 \text{ kg/storey}$

Seismic mass ($G + \psi_{Ei} Q$) of one storey: $360000 + 79200 + 38384 + 32400 = 509984 \text{ kg}$

Seismic mass $m = G + \psi_{Ei} Q$ of the building (6 storeys): $6 \text{ (storeys)} \times 509984 = 3060.10^3 \text{ kg}$

Interestingly, the steel frame represents only 7.5 % of the total seismic mass (and could be approximated as a constant mass in the first iterations of a design). The floors however represent 70% of the total seismic mass m , so a reduction of the floor weight by means of an alternative flooring system would be an effective way to substantially reduce the earthquake actions (by reducing the seismic mass), and subsequently the cost of the building.

5.7 Evaluation of seismic design shear using the ‘lateral forces’ method

In this section the approximate ‘lateral forces’ method is considered.

Estimate the fundamental period of the structure:

$$T = C_t H^{3/4} \quad C_t = 0.085 \quad H = 6 \times 2.9 \text{ m} = 17.4 \text{ m} \quad \Rightarrow T = 0.085 \times 17.4^{3/4} = 0.72 \text{ s}$$

Calculate the corresponding design pseudo acceleration $S_d(T)$: $T_C < T < T_D$

$$\Rightarrow S_d(T) = (2.5 \times a_g \times S \times T_C) / (q \times T) = (2.5 \times 2 \times 1.2 \times 0.5) / (4 \times 0.72) = 1.04 \text{ m/s}^2$$

Calculate the seismic design shear F_{bR}

$$F_{bR} = m S_d(T) \lambda = 3060.10^3 \times 1.04 \times 0.85 = 2705.10^3 \text{ N} = 2705 \text{ kN}$$

F_{bR} is the total design seismic shear applied to the building in either the x or y direction (they are the same because the estimation of T is only related to the building height). This corresponds to a deformed shape which is purely translational in the x or y directions.

In this example, calculations are presented for frames in the x direction. All six frames are the same, and with a floor diaphragm that is assumed to be effective enough to evenly distribute the force, then the seismic design shear F_{bX} in one frame is: $F_{bX} = F_{bR} / 6 = 451 \text{ kN}$

Torsional effects have to be added to the translational effects. In the structure analysed, due to double symmetry in the x and y directions, the centre of mass CM and the centre of rigidity CR are both, at all levels, at the geometrical centre of the building. This means that only accidental eccentricity results in torsional forces. In this example, torsion is therefore taken into account by amplifying F_{bX} by $\delta = 1 + 0.6x/L$. In this expression, L is the horizontal dimension of the building perpendicular to the earthquake in direction x (30m), while ‘ x ’ is the distance from the centre of rigidity to the frame in which the effects of torsion are to be evaluated. The greatest effect is obtained for the greatest x , which is $x = 0.5 L$ (15m), so that: $\delta = 1 + 0.6 \times 0.5 = 1.3$

The design shear F_{bX} including torsional effects is therefore: $F_{bX} = 1.3 \times 451 \text{ kN} = 586 \text{ kN}$

[Note: If the final design was to be based only on a planar analysis as described above, δ would be taken equal to: $\delta = 1 + 1.2 x/L$, as prescribed in Eurocode 8. However, the example described here

has been developed assuming that a final design using 3D modal response analysis will be performed after 'satisfactory' sizes of the beams and columns have been established. The value $(1 + 0.6 x/L)$ used for δ is known to be close to the real value for the type of frame analysed].

Definition of storey forces.

As all storey seismic masses are equal the distribution of storey forces is triangular and the storey

forces are given by : $F_i = F_b \cdot \frac{z_i}{\sum z_j}$

The resultant design base shear F_{bx} in frame X1, including torsional effects, is: $F_{bx} = 586$ kN

The storey forces are: $F1= 27.9$ kN $F2= 55.8$ kN $F3= 83.7$ kN $F4= 111.6$ kN

$F5= 139.5$ kN $F6= 167.5$ kN

Earthquake action effects.

The earthquake action effects E are determined using a static analysis under the storey forces.

Results are given in section 5.10, where they are compared to those from a dynamic analysis.

5.8 Gravity load combined with earthquake effects

Beam sections are checked under combined earthquake and coincident gravity loading using the following combination: $G + \psi_{2i} Q = G + 0.3 Q$

$\psi_{2i} Q = 0.3 Q = 0.3 \times 300 \text{ kg} \times 720 \text{ m}^2 = 64800 \text{ kg /storey}$

The total design mass at one storey is:

$G + 0.3 Q = 360000 + 79200 + 38384 + 64800 = 542384 \text{ kg}$

Line X2 carries 1/5 of that mass (line X1 and X6 carry each 1/10, while lines X2 to X5 carry 1/5 each).

The vertical load $(G + \psi_{2i} Q)$ /m of beam in line X2 is: $542384 / (5 \times 24\text{m}) = 4520 \text{ kg/m}$

$G + \psi_{2i} Q = 45.2 \text{ kN/m}$

5.9 Dynamic analysis by spectral response and modal superposition method

A planar analysis of a single frame in line X1 is considered.

The seismic mass $G + \psi_{Ei} Q$ for one frame is 1/6 of the total seismic mass of the building.

As the façade in direction x is 24m long and there are six levels of beams, the mass

$(G + \psi_{Ei} Q)$ /m of beam is: $G + \psi_{Ei} Q = 3060000 / (6 \times 6 \times 24) = 3542 \text{ kg/m}$

The design peak ground acceleration is $a_g = 2.0 \text{ m/s}^2$.

Torsional effects have to be added to the translation effects, and this is done by amplifying the action (the spectrum) by the factor $\delta = 1.3$ explained above, so that the value of a_g considered for the analysis is : $a_g = 2 \times 1.3 = 2.6 \text{ m/s}^2$

5.10 Results of the analysis

Figure 5.10.1 presents bending moments under earthquake loading obtained by the lateral force method. Figure 5.10.2 presents bending moments under earthquake loading obtained by the dynamic analysis (spectral response – modal superposition) method. Due to the SRSS (Square Root of the Sum of the Squares) combination of modes, action effects such as bending moments are all defined as positive.

The bending moments shown in Figure 5.10.2 are a more realistic representation of the real bending moment diagram at a given time, with moments at the beam ends which are of opposite sign. Bending moments at any point in the structure can be either positive or negative, due to reversal of the earthquake action.

The values obtained by the dynamic analysis are smaller than those from the lateral force method. This is due to the use of correct values of periods in the dynamic analysis; the first mode period $T_1 = 1.17 \text{ s}$ is greater than the estimated 0.72s of the lateral force method, and a smaller pseudo acceleration $S_d(T)$ corresponds to a greater period T_1 for $T_1 > T_C$ of the design spectrum. The analysis also shows that first modal mass is 82.7 % of the total seismic mass m . The second modal period is $T_2=0.368 \text{ s}$ and the second modal mass is 10.4 % of the total seismic mass m . Figure 5.10.3 and 5.10.4 present the deformed shapes in vibration modes 1 and 2.

Tables 5.10.1 and 5.10.2 give details of the checks made on the limitation of $P-\Delta$ effects with the results from both the lateral force method and the dynamic analysis. The values of the resultant base shear from both methods are indicated in those tables: 586.0 kN (lateral force method, for one frame) and 396.2 kN (dynamic response).

It can be seen that the value of the parameter θ does not differ much from one type of analysis to the other. θ is ≤ 0.1 at storeys 1, 4, 5, 6 . Bending moments and other action effects found from the analysis at storeys 2 and 3 have to be increased by $1/(1-\theta)$ (1.16 at storey 2 and 1.13 at storey 3).

Figure 5.10.5 presents the bending moment diagram under the combination used for the checks of structural elements: $E + G + \psi_{2i} Q$ (in which bending moments are taken from the lateral force method).

The maximum beam moment is at storey 2: 509.8 kNm

With the $1/(1-\theta)$ increase: $1.16 \times 509.8 = 591.4 \text{ kNm}$

Beams are IPE500 : $M_{pl,Rd} = 2194.10^3 \times 355 = 778.9 \text{ kNm} > 591.4 \text{ kNm}$

The maximum moment in interior columns is: 481 kNm (at the base, as moments at storeys 1 and 2 are inferior to that value even with the $1/(1-\theta)$ increase).

Interior columns are HE340M bending about their strong axis:

$$M_{pl,Rd} = 4718.10^3 \times 355 = 1674.9 \text{ kNm} > 481 \text{ kNm}$$

The maximum moment in exterior columns is 195.2 kNm ,at the base of columns (moments at storeys 1 and 2 are inferior to that value even with the $1/(1-\theta)$ increase).

Exterior columns are HE340M bending about their weak axis:

$$M_{pl,Rd} = 1953.10^3 \times 355 = 693.3 \text{ kNm} > 195.2 \text{ kNm}$$

Checks under the service earthquake, which is assumed to be half of the design earthquake, raise no concerns. Interstorey drifts D_s are half of those given in Tables 5.10.1 and 5.10.2, with a maximum:

$$D_s = 0.5 \times 0.054 \times 1 / (1 - \theta) = 0.031\text{m}$$

$$D_s / h = 0.031\text{m} / 2.9 = 0.0108 = 1.1 \%$$

This value is acceptable with infills and partitions that are independent of the structure.

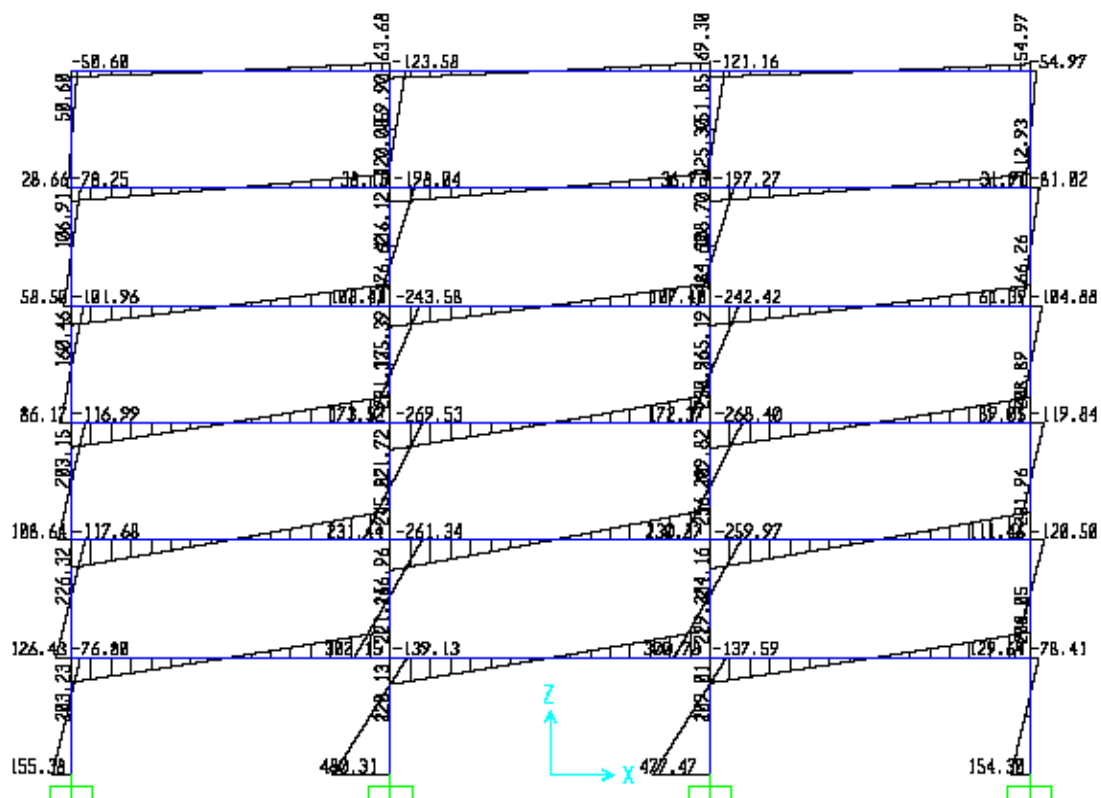

Fig. 5.10.1 Diagram of bending moments under earthquake action obtained by the lateral force method. Units: kNm.

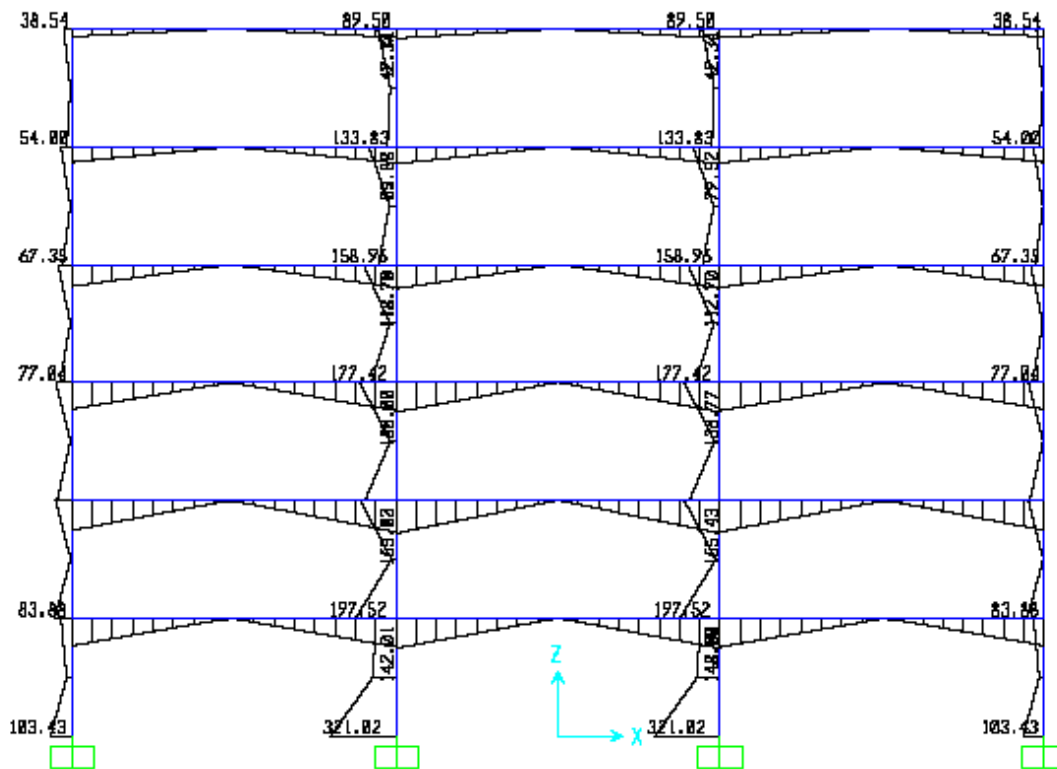

Fig. 5.10.2 Diagram of bending moments under earthquake action from the dynamic analysis.
Units: kNm.

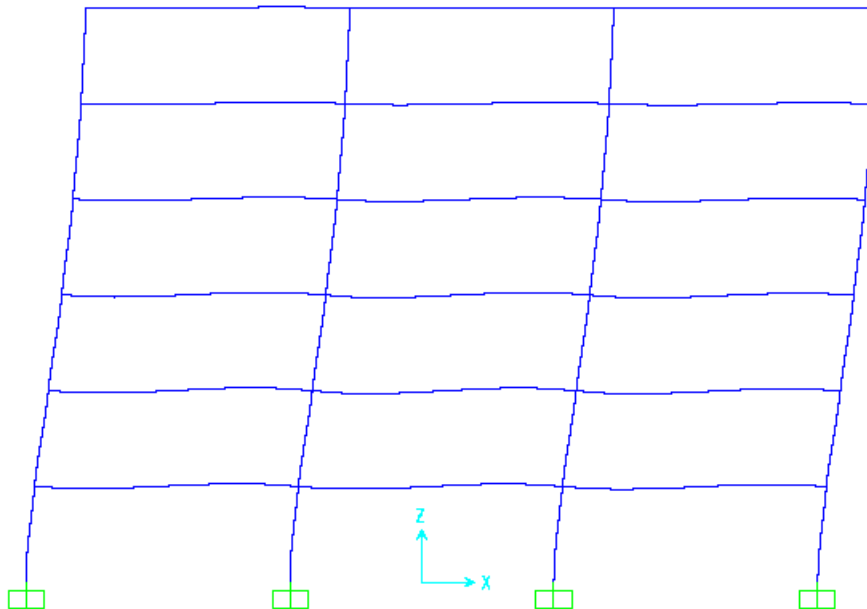

Fig. 5.10.3 Deformed shape in vibration mode 1

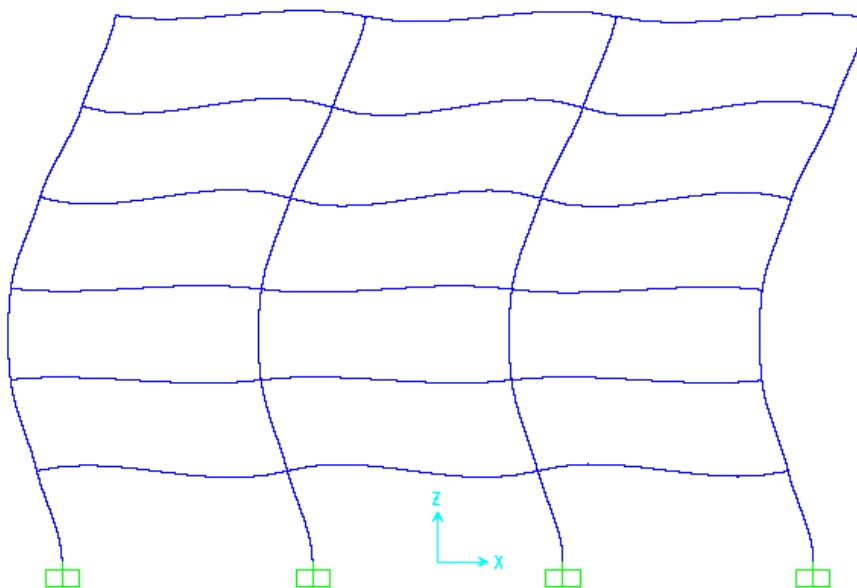

Fig. 5.10.4 Deformed shape in vibration mode 2

Table 5.10.1 Results from the lateral force method analysis

Lateral force method		$= E_s + G + \psi_{Ei} \cdot Q$				$G + \psi_{Ei} \cdot Q = 35.42 \text{ kN/m}$									
Storey	Absolute displacement of the storey : d_i [m]		Design interstorey drift $(d_i - d_{i-1})$: d_{r_i} [m]		Storey lateral forces E_i : V_i [kN]		Shear at storey E_i : V_{tot} [kN]		Total cumulative gravity load at storey E_i : P_{tot} [kN]		Storey height E_i : h_i [m]		Interstorey drift sensitivity coefficient $(E_i - E_{i-1})$: θ		
E_0	d_0	0	d_{r0}												
E_1	d_1	0.033	d_{r1}	0.033	V_1	27.9	V_{tot1}	586.0	P_{tot1}	5100	h_1	2.9	θ_1	0.100	
E_2	d_2	0.087	d_{r2}	0.054	V_2	55.8	V_{tot2}	558.1	P_{tot2}	4250	h_2	2.9	θ_2	0.141	
E_3	d_3	0.139	d_{r3}	0.052	V_3	83.7	V_{tot3}	502.3	P_{tot3}	3400	h_3	2.9	θ_3	0.122	
E_4	d_4	0.184	d_{r4}	0.044	V_4	111.6	V_{tot4}	418.6	P_{tot4}	2550	h_4	2.9	θ_4	0.093	
E_5	d_5	0.216	d_{r5}	0.033	V_5	139.5	V_{tot5}	307.0	P_{tot5}	1700	h_5	2.9	θ_5	0.062	
E_6	d_6	0.238	d_{r6}	0.021	V_6	167.5	V_{tot6}	167.5	P_{tot6}	850	h_6	2.9	θ_6	0.037	
Behaviour factor :				$q = 4$				$\theta = \frac{P_{tot} \cdot d_r}{V_{tot} \cdot h} \leq 0.10$							

Table 5.10.2 Results from the modal superposition analysis

Modal superposition		$= E_s + G + \psi_{Ei} \cdot Q$										$G + \psi_{Ei} \cdot Q = 35.42 \text{ kN/m}$			
Dynamic analysis.															
Storey	Absolute displacement of the storey : d_i [m]		Design interstorey drift $(d_i - d_{i-1})$: d_i [m]		Storey lateral forces E_i : V_i [kN]		Shear at storey E_i : V_{tot} [kN]		Total cumulative gravity load at storey E_i : P_{tot} [kN]		Storey height E_i : h_i [m]		Interstorey drift sensitivity coefficient $(E_i - E_{i-1})$: θ		
	E_0	d_0	0	d_{r0}											
E_1	d_1	0.022	d_{r1}	0.022	V_1	26.6	$V_{tot 1}$	396.2	$P_{tot 1}$	5100	h_1	2.9	θ_1	0.099	
E_2	d_2	0.057	d_{r2}	0.035	V_2	42.9	$V_{tot 2}$	369.7	$P_{tot 2}$	4250	h_2	2.9	θ_2	0.137	
E_3	d_3	0.090	d_{r3}	0.033	V_3	50.0	$V_{tot 3}$	326.8	$P_{tot 3}$	3400	h_3	2.9	θ_3	0.118	
E_4	d_4	0.117	d_{r4}	0.027	V_4	61.1	$V_{tot 4}$	276.7	$P_{tot 4}$	2550	h_4	2.9	θ_4	0.086	
E_5	d_5	0.137	d_{r5}	0.020	V_5	85.0	$V_{tot 5}$	215.6	$P_{tot 5}$	1700	h_5	2.9	θ_5	0.054	
E_6	d_6	0.148	d_{r6}	0.012	V_6	130.6	$V_{tot 6}$	130.6	$P_{tot 6}$	850	h_6	2.9	θ_6	0.027	
Behaviour factor :												$q = 4$		$\theta = \frac{P_{tot} \cdot d_T}{V_{tot} \cdot h} \leq 0,10$	

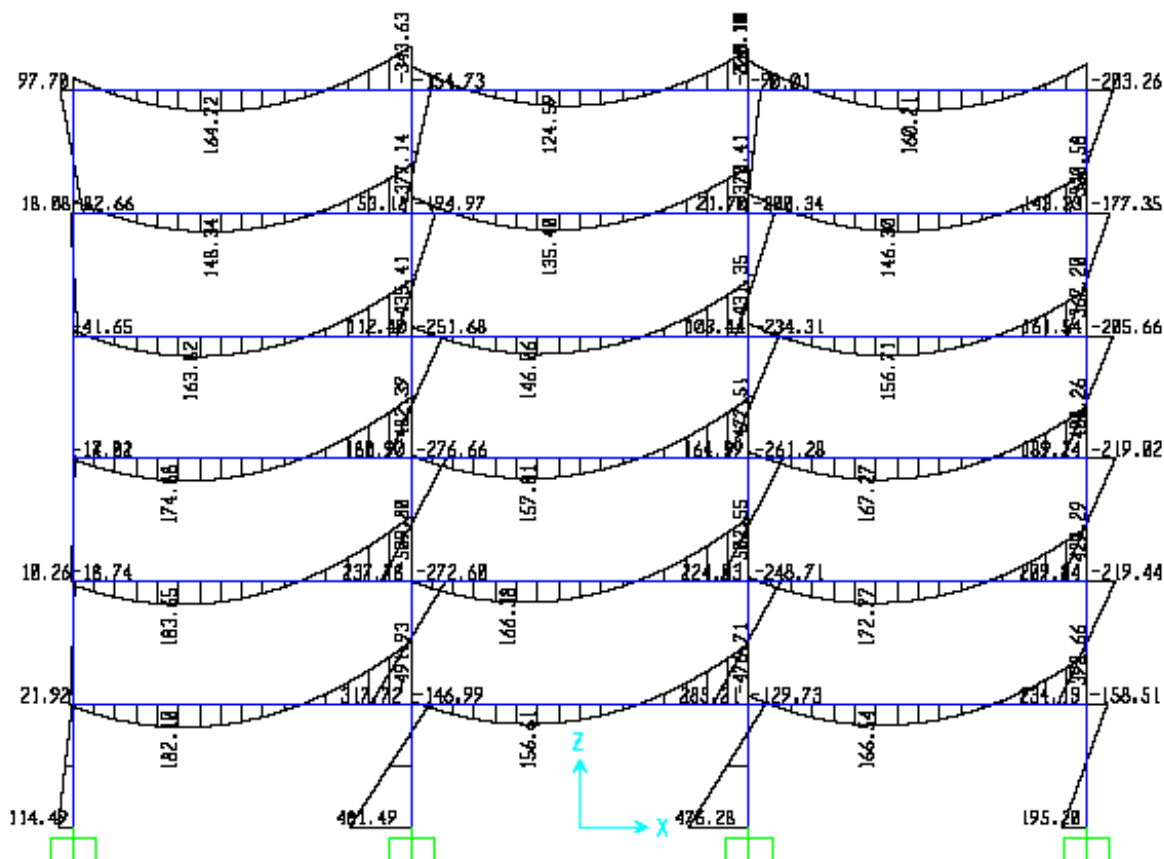

Fig. 5.10.5 Bending moment diagram under the combination used for the checks of structural elements: $E + G + \psi_{21} Q$. Units: kNm.

5.11 Design of beam to column connection at an interior joint in line X2

The example connection in line X2 connects an IPE500 beam to a HE340M column. Both are made of S355 steel. A connection type valid for a Ductility Class DCH is selected. This is an unstiffened end plate connection; extended end plates are welded to the beam during fabrication and bolted to the column flanges on site.

The design also involves consideration of the beam connections in line Y2, which are similar; extended end plates are welded to the IPEA450 beams during fabrication and are bolted on site to vertical plates welded to the columns flanges (see Figures 5.12.1 and 5.12.2).

Design checks are presented below for the connections in line X2 only.

Design moment and shear at the connection of the IPE500 beam.

The design moment and shear are related to a design situation in which plastic hinges are formed at all the beams ends in line X2 (at all storeys). The design values are established considering possible beam material real strength that is greater than the nominal $f_y = 355 \text{ N/mm}^2$. This is achieved using a γ_{ov} factor, and a partial safety factor of 1.1:

$$M_{Rd,connection} \geq 1.1 \gamma_{ov} M_{pl,Rd,beam} = 1.1 \times 1.25 \times 778.9 = 1071 \text{ kNm}$$

$$V_{Rd,connection} \geq V_{Ed} = V_{Ed,G} + 1,1\gamma_{ov} \Omega V_{Ed,E}$$

$$V_{Ed,E} = 2 M_{pl,Rd,beam} / l = 2 \times 778.9 / 8 = 194.7 \text{ kN}$$

$V_{Ed,G}$ is found under $G + \psi_{2i} Q$ (= 45.2 kN/m, see above)

$$V_{Ed,G} = 0.5 \times 8 \times 45.2 = 180.8 \text{ kN}$$

$$V_{Rd,connection} \geq 180.8 + 1.1 \times 1.25 \times 194.7 = 448.5 \text{ kN}$$

Given the design values of bending moment and shear, the design is based on the requirements of Eurocode 3 (EN1993-1-8) with additional consideration of some specific requirements from Eurocode 8 (EN1998-1:2004).

Design of welds between end plates and beams.

Butt welds with adequate preparation and execution (V grooves, welding from both side) satisfy the overstrength design criterion by default so no calculation is needed.

Design of bolts.

The bending moment $M_{Rd,connection}$ is transferred by 4 rows of 2 M36 grade 10.9 bolts.

For row 1, $h_r = 500 - 16 + 70 = 554 \text{ mm}$. For row 2, $h_r = 500 - 16 - 70 = 414 \text{ mm}$.

The resistance $F_{tr,Rd}$ of an M36 grade 10.9 bolt in tension is:

$$F_{tr,Rd} = 0.9 f_u A_s / \gamma_{M2} = 0.9 \times 1000 \times 817 / 1.25 = 735.3 \text{ kN} / 1.25 = 588.2 \text{ kN}$$

$$M_{Rd,assemblage} = (554 + 414) \times 2 \times 588.2 = 1138.10^3 \text{ kNmm} = 1138 \text{ kNm} > 1071 \text{ kNm}$$

Shear is transferred by 6 M20 grade 10.9 bolts placed on both sides of the web and designed to carry the design shear in its entirety.

Design resistance of bolts in shear: $6 \times 122.5 / 1.25 = 588 \text{ kN} > 448.5 \text{ kN}$

Design bearing resistance of plate (40 mm thickness, see below):

$$V_{Rd,plate} = (6 \times 193 \times 40) / (10 \times 1.25) = 3705 \text{ kN} > 448.5 \text{ kN}$$

Design of end plate.

The total design tension force $F_{tr,Rd}$ applied by one flange to the end plate is:

$$F_{tr,Rd} = M_{Rd} / (500 - 16) = 1071.10^3 / 484 = 2213 \text{ kN}$$

The virtual work equation on which end plate design in EN1993-1-8 is based indicates:

$$4 M_{pl,1,Rd} \times \theta = F_{tr,Rd} \times \theta \times m$$

θ is the rotation in a plastic yield line over the width of the plate (the yield line is horizontal); $M_{pl,1,Rd}$ is the plastic moment developed along this yield line; 4 is the number of yield lines when prying action is accepted – Figure 5.12.3; m is the distance from the bolt axis to the flange surface (70 mm, see Figure 5.12.2).

For yielding to develop in the beam and not in the plate the following condition should be satisfied:

$$4 M_{pl,1,Rd} \times \theta > F_{tr,Rd} \times \theta \times m$$

$$M_{pl,1,Rd} = (I_{eff} \times t^2 \times f_y) / 4\gamma_{M0}$$

$$I_{eff} = 300 \text{ mm}$$

$$\gamma_{M0} = 1.0$$

$$f_y = 355 \text{ N/mm}^2$$

$$(4 \times 300 \times t^2 \times 355) / 4 = 2213 \cdot 10^3 \times 70$$

$$\Rightarrow t = 38.1 \text{ mm as minimum} \Rightarrow t = 40 \text{ mm}$$

Note.

As:

- the thickness t_f of the column flange is also 40 mm
- the distance to the column web is $(150/2) - (t_w/2) = 75 - 21/2 = 64.5 \text{ mm} < 70 \text{ mm}$
- the length of a potential vertical yield line in the column flange is $(70 + 16 + 70) + (2 \times 70) = 296 \text{ mm} \approx 300 \text{ mm}$

It can be deduced that the flange has the required resistance to accommodate the tension from the connection, without need of transverse stiffeners.

Check of resistance of end plate and column flange to punching.

The resistance $B_{p,Rd}$ of the end plate and of the column flange to punching by one bolt should be greater than the tension $F_{tr,Rd}$ that can be applied by that bolt: $B_{p,Rd} > F_{tr,Rd}$

The check is identical for both the end plate and the column flange since they have the same thickness (40 mm) and yield strength (355 N/mm²).

$$F_{tr,Rd} = 2213 / 4 = 553 \text{ kN}$$

$B_{p,Rd}$ is taken as the shear resistance corresponding to punching out a cylinder of diameter d_m of the head of the bolt (58 mm for a M36 bolt) and thickness t_p of the plate (40 mm):

$$B_{p,Rd} = 0.6 \pi d_m t_p f_u = 0.6 \times 3.14 \times 58 \times 40 \times 500 / 1.25 = 2185 \cdot 10^3 \text{ N} = 2185 \text{ kN} > 553 \text{ kN}$$

Check of column web panel in shear.

In the design situation plastic hinges are formed in the beam sections adjacent to the column on its left and right sides. The horizontal design shear $V_{wp,Ed}$ in the panel zone is therefore equal to:

$$V_{wp,Ed} = M_{pl,Rd, left} / (d_{left} - 2t_{f,left}) + M_{pl,Rd, right} / (d_{right} - 2t_{f,right}) + V_{Sd, c}$$

Neglecting $V_{Sd, c}$:

$$V = 2 \times 1071 \cdot 10^3 / (377 - 2 \times 40) = 7212 \text{ kN}$$

$$V_{wb,Rd} = (0.9 f_y A_{wc}) / (\sqrt{3} \times \gamma_{M0}) = (0.9 \times 355 \times 9893) / (\sqrt{3} \times 1.0) = 1824 \cdot 10^3 \text{ N}$$

$$V_{wb,Rd} = 1824 \text{ kN} \ll 7212 \text{ kN}$$

The column web area therefore needs to be increased by adding plates with a shear resistance of: $7212 - 1824 = 5388 \text{ kN}$

$$\text{This corresponds to an additional shear area: } (5388 \cdot 10^3 \sqrt{3}) / (355 \times 0.9) = 29209 \text{ mm}^2$$

The design of the connections for the beams oriented in the y direction requires two plates of 297 mm length and thickness equal to: $29209 / (2 \times 297) = 49.2 \text{ mm} \Rightarrow 50 \text{ mm}$ (Figure 5.12.1).

Check of column web panel in transverse compression.

This check refers to cl. 6.2.6.2 of EN1993-1-8.

$$F_{c,wc,Rd} = \omega k_{wc} b_{eff,c,wc} t_{wc} f_{y,wc} / \gamma_{M0}$$

A simple check is made by:

- o setting ω and k_{wc} at 1.0 and taking $b_{\text{eff,c,wc}} = t_{fb} + 5(t_{fc} + s) = 16 + 5(40 + 27) = 351$ mm (both of these are safe-sided assumptions)
- o $\gamma_{M0} = 1.0$
- o ignoring the connecting plates of beams in the y direction

$$F_{c,wc,Rd} = 351 \times 21 \times 355 = 2616 \cdot 10^3 \text{ N} = 2616 \text{ kN} > F_{tr,Rd} = 2213 \text{ kN}$$

The check is therefore satisfied. A more comprehensive check would include taking the connecting plates of beams in the y direction into account:

$$b_{\text{eff,c,wc}} = t_{fb} + 5(t_{fc} + s) = 16 + 5(40 + 27 + 40 + 40) = 751 \text{ mm}$$

Check of column web panel in transverse tension.

This check refers to cl. 6.2.6.3 of EN1993-1-8.

$$F_{c,wc,Rd} = \omega b_{\text{eff,c,wc}} t_{wc} f_{y,wc} / \gamma_{M0}$$

The check is identical to the one above, and is therefore satisfied.

5.12 Comment on design options

The design presented above is governed by the limitation of deflections, both in terms of P- Δ effects under the design earthquake loading and inter-storey drift under the serviceability earthquake loading. This means that the section sizes chosen for the beams inevitably possess a safety margin for resistance; $M_{pl,Rd} = 778.9 \text{ kNm} > M_{Ed} = 591.4 \text{ kNm}$ (which is the worst case applied moment). Making use of redistribution of moments would not enable smaller beam sections to be used, as this would result in an unacceptable level of flexibility in the structure.

Reducing the beam sections locally, close to the connections ('dogbones' or RBS) should however be considered. Such an approach would only change the structure stiffness by a few percent so it would still comply with design requirements for deformation, but would provide a useful reduction in the design moments (and shears) applied to the beam to column connections. At the interior joints the IPE500 plastic moment $M_{pl,Rd}$ could be reduced by the ratio $778.9/591.4 = 1.32$ (that is a 32% reduction). Using RBS would allow reduced bolt diameters and end plate thicknesses. At the connections to the perimeter columns, where IPE500 beams are connected into the column minor axis, the reduction could be greater since the maximum value of M_{Ed} is only 481 kNm allowing a reduction ratio of 1.61 (that is 61% reduction).

Other design options could be considered to reduce fabrication and construction costs. Using nominally pinned connections for the beams framing into the column minor axes would simplify the column 'nodes'. The loss of frame stiffness could be compensated by using deeper beam and column sections. Alternatively, it might be interesting to reduce the number of frames that provide most of the earthquake resistance. For instance, frames in lines Y1 and Y4 could be dedicated to earthquake resistance in the y direction, while frames in lines X1, X4 and X6 could be dedicated to earthquake resistance in the x direction. Smaller beam sections and low cost connections could be used in the frames on other grid lines.

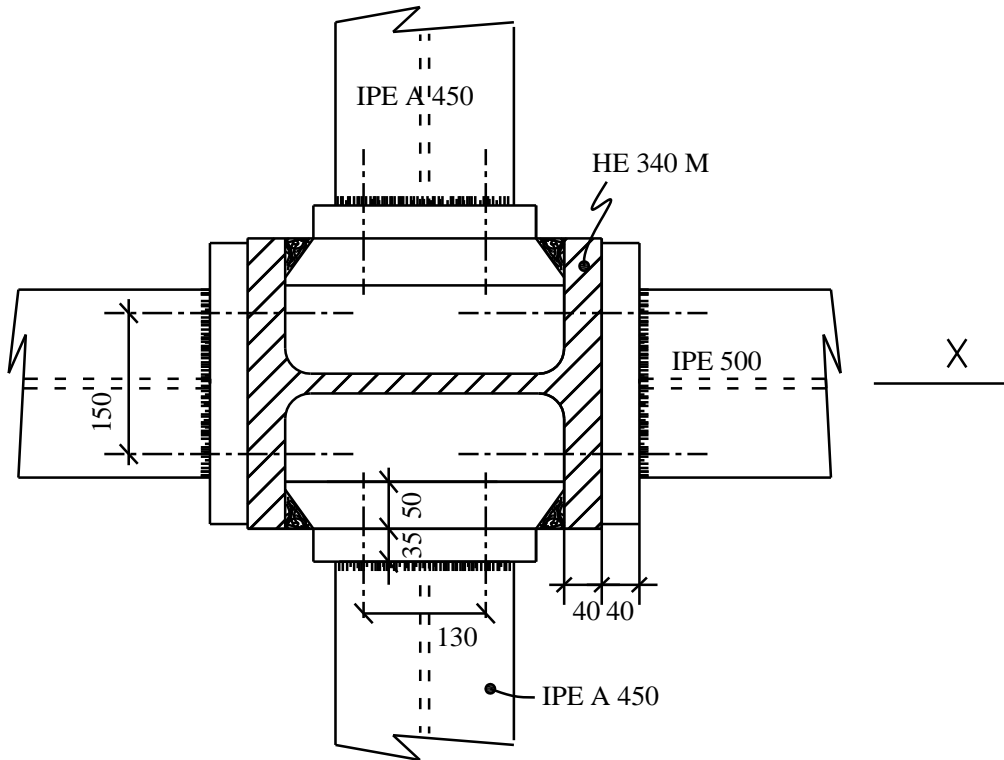

Fig. 5.12.1 Plan view of beam to column connections

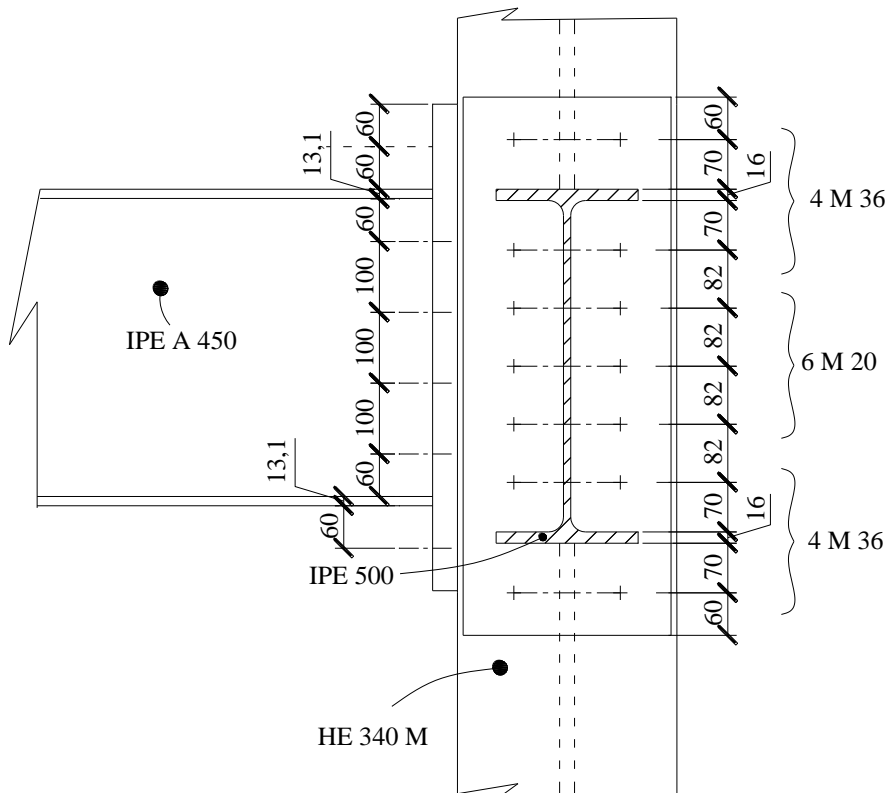

Fig. 5.12.2 Elevation of beam to column connections

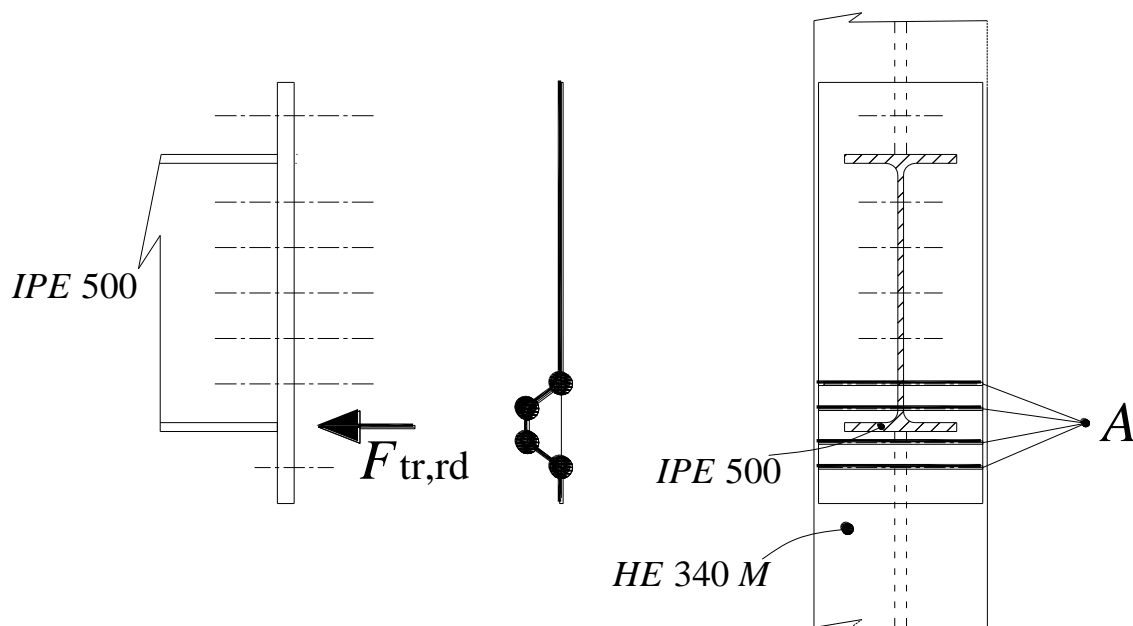

Fig. 5.12.3 Plastic deformation mechanism in the end plate of the IPE500 beam

5.13 Design of reduced beam sections

Objective.

The analysis has indicated a maximum bending moment of 592.4 kNm in the IPE500 beams in the x direction under the seismic load combination $E + G + \psi_{2i} Q$. Because the beams are deflection governed there is an excess of resistance which is equal to: $778.9 : 592.4 = 1.32$. The objective in considering the use of reduced beam sections is to limit the beam end moment to a value at or near to 592.4 kNm.

In principle this could be achieved by trimming the flanges of the beam adjacent to the column connection, but experiments have shown that better ductility is achieved by locating the reduced section some distance away from the beam end. This means the limiting moment has a slightly different value, which must be determined. The design moment to consider is influenced by the increase in flexibility due to the reduced beam section. In the paragraphs that follow, the design moment in the RBS is evaluated considering these two factors.

Influence of increase in flexibility due to RBS.

Reducing the beam sections (RBS) increases frame flexibility and therefore drift by an estimated 7% (see section 5.6 and 5.7), which results in an increase in θ also of 7%. Therefore the amplification factors $1 / (1 - \theta)$ which are given in Table 5.10.2 should be recalculated considering the modified values of θ as shown in Table 5.13.1.

Table 5.13.1 Modified amplification factors $1/(1-\theta)$

Storey	Interstorey drift sensitivity coefficient θ		amplification factor $1/(1-\theta)$
	Without RBS	With RBS	With RBS
1	0.099	0.105	1.11
2	0.137	0.147	1.17
3	0.118	0.126	1.14
4	0.086	0.092	1
5	0.054	0.057	1
6	0.027	0.028	1

Only the worst case value [$1/(1-\theta) = 1.17$] is considered in the design, because all RBS will have the same dimensions at all levels. The maximum moment applied at the beam ends under the combination $E + G + \psi_{2i} Q$, without considering the amplification factors $1/(1-\theta)$, was 509.8 kNm. When reduced sections are used that maximum moment is amplified by 1.17 due to the increase in flexibility: $1.17 \times 509.8 = 596.5$ kNm

Clearly this value is not very different from the value without RBS (592.4 kN)

Influence of RBS distance to connection.

To take into account the fact that the RBS is located at some distance away from the column face, it is necessary to choose dimensions which comply with recognised guidance. Consider:

$$a = 0.5 \times b = 0.5 \times 200 = 100 \text{ mm}$$

$$s = 0.65 \times d = 0.65 \times 500 = 325 \text{ mm}$$

The distance from the RBS to the column face is $a + s/2$ (see Figure 5.13.1).

$$a + s/2 = 162.5 + 100 = 262.5 \text{ mm}$$

The maximum moment is obtained at the beam end, and the bending moment diagram can be approximated as being linear between the beam end and 1/3 span point, so that the design bending moment in the RBS is as follows.

$$1/3 \text{ span} = 8000 / 3 = 2666 \text{ mm}$$

$$M_{d,RBS} = 596.5 \times (2666 - 262.5) / 2666 = 537 \text{ kNm}$$

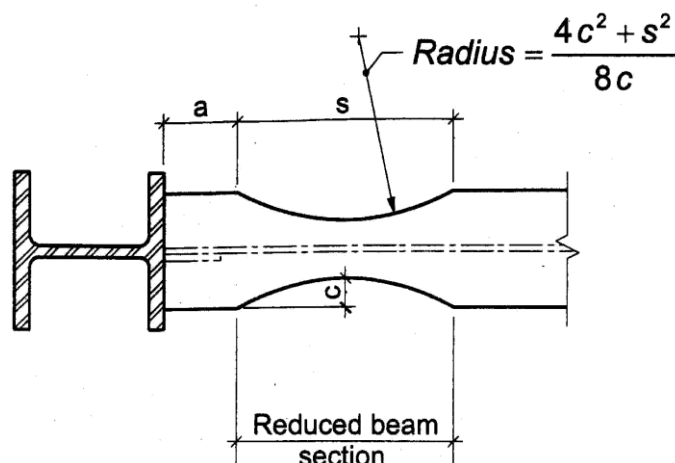

Fig. 5.13.1 Symbols used in definition of RBS

Definition of section cuts at RBS.

The RBS cut dimension c should be in the range $c = 0.20 b$ to $0.25 b$

Consider $c = 0.22b = 0.22 \times 200 = 44 \text{ mm}$.

The plastic moment of an IPE500 section (without any reduction) is equal to:

$$W_{pl,y} f_y = 2194 \cdot 10^3 \times 355 = 778 \cdot 10^6 \text{ Nmm}$$

This results from the addition of:

$$\text{Flange moment: } b t_f f_y (d - t_f) = 16 \times 200 \times 355 (500 - 16) = 549 \cdot 10^6 \text{ Nmm}$$

$$\text{Web moment: } t_w f_y (d - 2t_f)^2 / 4 = 10.2 \times 355 \times (500 - 32)^2 = 198 \cdot 10^6 \text{ Nmm}$$

$$\text{Moment due to root radii at web-flange junctions: } = (778 - 549 - 198) = 31 \cdot 10^6 \text{ Nmm}$$

The plastic moment of a 'reduced' IPE500 (RBS) is calculated as follows:

$$b_e = b - 2c = 200 - 88 = 120 \text{ mm.}$$

$$\text{Flange moment: } b_e t_f f_y (d - t_f) = 16 \times 112 \times 355 (500 - 16) = 308 \cdot 10^6 \text{ Nmm}$$

$$\text{RBS plastic moment: } M_{pl,Rd,RBS} = (308 + 198 + 31) \cdot 10^6 = 537 \cdot 10^6 \text{ Nmm} = 537 \text{ kNm}$$

For fabrication purposes it is also necessary to know the radius R of the cut (see Figure 5.13.1). This is calculated as: $R = (4c^2 + s^2) / 8c = (4 \times 32^2 + 325^2) / (8 \times 32) = 857 \text{ mm}$.

Design moment and design shear at the connection.

The shear in the RBS due to the earthquake action corresponds to the situation when plastic hinges form at the left and right hand ends of the beam. This is therefore given by:

$$V_{Ed,E} = 2 M_{pl,Rd,RBS} / L'$$

in which L' is the distance between the plastic hinges at the extremities of the beam.

$$L' = 8000 - 377 - (2 \times 262.5) = 7098 \text{ mm} = 7.098 \text{ m}$$

$$V_{Ed,E} = 2 \times 537 / 7.098 = 151 \text{ kN}$$

The shear $V_{Ed,G}$ in the RBS due to gravity loading $G + \psi_{2i} Q$ is :

$$V_{Ed,G} = 0.5 \times 7.098 \times 45.2 = 160.4 \text{ kN}$$

The total shear in the RBS is:

$$V_{Ed,E} = V_{Ed,G} + 1.1 \gamma_{ov} V_{Ed,E} = 160.4 + 1.1 \times 1.25 \times 151 = 368 \text{ kN}$$

The design moment $M_{Ed,connection}$ applied to the beam end connections is:

$$M_{Ed,connection} = 1.1 \gamma_{ov} M_{pl,Rd,RBS} + V_{Ed,E} \times X \quad \text{with } X = a + s/2 = 262.5 \text{ mm}$$

$$M_{Ed,connection} = 1.1 \times 1.25 \times 537 + 368 \times 0.2625 = 834 \text{ kNm}$$

Thanks to the RBS, the design moment $M_{Ed,connection}$ for the beam end connections has been reduced from 1071 kNm down to 834 kNm. The reduction in design moment for the connections, due to RBS, is therefore 28%.

$$\text{The design check for shear at the connection is: } V_{Rd,connection} \geq V_{Ed} = V_{Ed,G} + 1.1 \gamma_{ov} \Omega V_{Ed,E}$$

$$\text{The condition was: } V_{Rd,connection} \geq 448 \text{ kN without RBS.}$$

$$\text{It is: } V_{Rd,connection} \geq 368 \text{ kN with RBS}$$

The reduction in design shear at the connection, due to RBS, is therefore 21%.

5.14 Economy due to RBS

The use of reduced beam sections can contribute significantly to the economy of the design by allowing a reduction of 28% in the design moment at the connection. This reduction is also reflected in the design shear applied to the panel zone of the column. Both types of reduction can bring significant reductions in cost.

Specific rules for the design and detailing of steel buildings:

(ii) Composite steel concrete moment resisting frames

H. Somja¹ , H. Degée² and. A. Plumier²

1: INSA Rennes

2:University of Liege

5.15 Structure Description

The structure is a 5-storey composite office building, with a height of 17.5 m. An intermediate beam in Y-direction allows adopting a slab's thickness of 12 cm. The slabs are made of reinforced concrete and are assumed to be rigidly joined to steel beam profiles. The surfaces of slabs are 21m (3 bays in the X-direction) by 24m (4 bays in the Y-direction). The dimensions of the building are defined in the Figures 5.15.1 and 5.15.2.

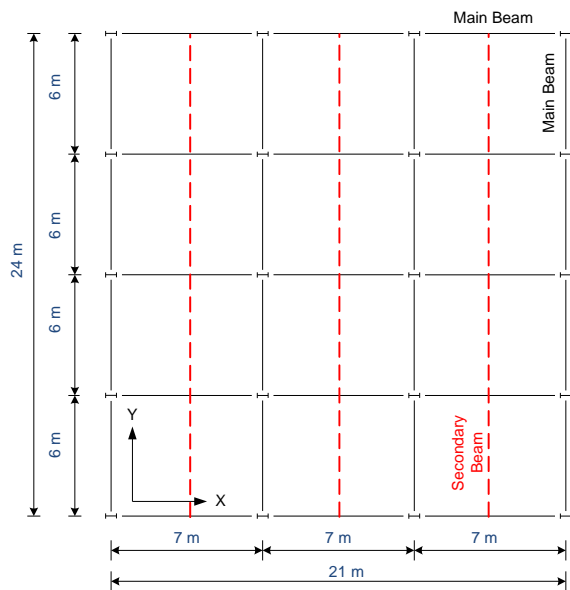

Fig. 5.15.1 Floor plan

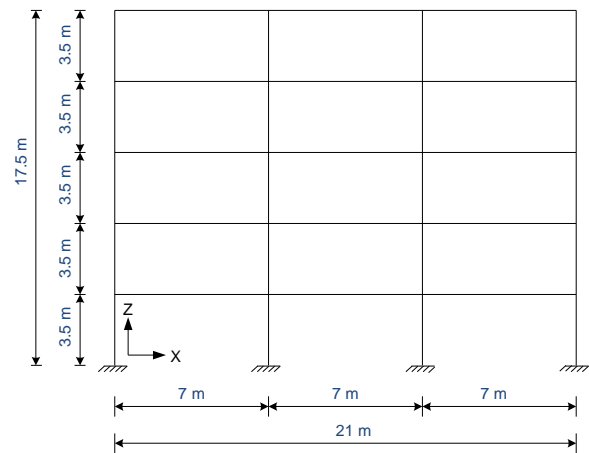

Fig. 5.15.2 Front elevation

The preliminary design of the multi-storey composite office building has been made in accordance with recommendations of Eurocodes 3, 4, and 8. Four cases are considered:

- o Case 1: building in a high seismicity zone, composite beams, steel columns
- o Case 2: building in a high seismicity zone, composite beams, composite columns.
- o Case 3: building in a low seismicity zone, composite beams, steel columns.
- o Case 4: building in a low seismicity zone, composite beams, composite columns.

The buildings are supposed to withstand the applied forces by a moment-resisting frame (MR) in the X direction (strong axis of columns) and by a braced frame in the other direction. MR direction is the only one considered in the design. Different mechanical characteristics have been considered in function of the seismicity level:

- o high seismicity : Profiles S355, Steel reinforcement S500, Concrete C30/37
- o low seismicity : Profiles S235, Steel reinforcement S450, Concrete C25/35

5.16 Characteristic Values of Actions on the Building

5.16.1 PERMANENT ACTIONS

They include the self-weight of the primary structure frame, supporting structures, completion and finishing elements connected with the structure. They also consist of services and machinery fixed permanently to the structure, in addition to the weight of slabs and partitions.

- o Slab: 5 kN/m²
- o Partitions: 3 kN/m
- o The beams and columns frame weight is calculated in the preliminary design.

5.16.2 VARIABLE ACTIONS

Imposed Load: the structure is category B: Office building (clause 6.3.1.1 and table 6.1 of [1]) and values of imposed loads conforming to French Annex are:

- o Uniformly distributed loads: $q_k = 3 \text{ kN/m}^2$
- o Concentrated loads: $Q_k = 4 \text{ kN}$

The snow load is, for a site altitude $A = 1200 \text{ m}$, $q = 1.1 \text{ kN/m}^2$

Wind Load : $q_p(Z) = 1.4 \text{ kN/m}^2$. Wind pressure acting on building surfaces: $W_f = 1.4 \text{ kN/m}^2$

5.16.3 SEISMIC ACTION

Recommended values of ψ factors corresponding to live loads, for an office building of category B are specified as (Annexe A1, clause A1.2.2 and tableau A1.1 of [7]):

$$\psi_0 = 0.7$$

$$\psi_1 = 0.5$$

$$\psi_2 = 0.3$$

Seismic design of the building is done for Medium ductility class (DCM). As the structure has a regular elevation with uniform distributions of lateral rigidities and masses, (clause 4.2.3.3 of [8]), the range of behaviour factor for a building of type B according to the Eurocode 8 (clause 7.3.2 and table 7.2 of [8] or clause 6.3.2 and table 6.2 of [8]) is: $2 < q \leq 4$. The behaviour factor adopted is: $q = 4$

Spectrum Data

For a soil of type B, the values of the parameters describing the recommended type 1 elastic response spectrum, (clause 3.2.2.2. and table 3.2 of [8]), are: $S=1.2$, $T_B = 0.15\text{s}$, $T_C = 0.5\text{s}$, $T_D = 2\text{s}$

For a building of an importance class II, the importance factor, (clause 4.2.5(5) and table 4.3 of [8]), is : $\gamma_I = 1$

The reference peak ground acceleration (a_{gR}) and the design ground acceleration (a_g) chosen for high and low seismic zones are shown below:

High seismicity zones		Low seismicity zones	
a_{gR}	$a_g = \gamma_I * a_{gR}$ m/s ²	a_{gR}	$a_g = \gamma_I * a_{gR}$ m/s ²
0.25g	2.453	0.10g	0.981

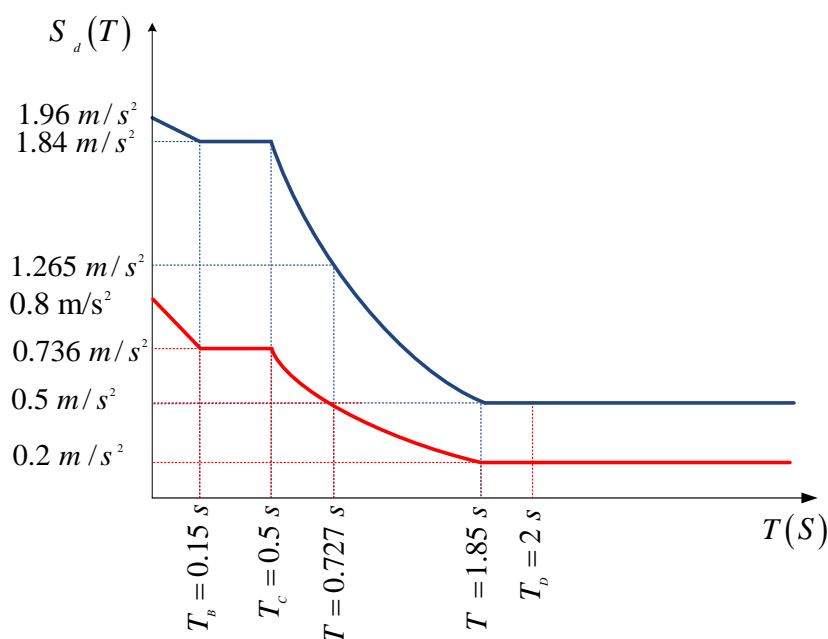

Fig. 5.16.1 .Response spectra for high and low seismicity zones considered in the design

Seismic Acceleration of the Structure

The fundamental period of vibration of the building for lateral motion in the direction considered, T_1 , is approximated by the following expression (clause 4.3.3.2.2(3) of [8]):

$$T_1 = C_t * H^{\frac{3}{4}}$$

$$T_1 = 0.727s$$

Where: $C_t = 0.085$ (clause 4.3.3.2.2(3)/Note of [8]) Building height, $H = 5 * 3.5 = 17.5m$

This estimation of T_1 is too rough, so the real period of the structure is computed. The table below provides the values of real structure's periods.

	Case1	Case2	Case3	Case4
Real period (T_1 in s)	1.64	1.72	1.35	1.41
Estimation by EN 1998 expression	0.727	0.727	0.727	0.727

As $T_C < T_1 < T_D$, the value of design spectrum associated with period of vibration is calculated by mean of the equation 3.15 (clause 3.2.2.5 of [8]):

$$S_d(T) = \begin{cases} a_g \cdot S \cdot \frac{2.5}{q} \cdot \left[\frac{T_C}{T} \right] \\ \geq \beta \cdot a_g = \begin{cases} 0.5 & \text{(Cases 1 and 2)} \\ 0.2 & \text{(Cases 3 and 4)} \end{cases} \end{cases}$$

Where β is the lower bound factor for the horizontal design spectrum (Recommended value $\beta = 0.2$). The table below provides the real design values as well as EN 1998 values of design spectrum and the corresponding period values.

		Case 1	Case 2	Case 3	Case 4
Real Values	$S_d(T_1)$ m/s ²	0.561	0.535	0.272	0.261
	Period (s)	1.64	1.72	1.35	1.41
Estimation by EN 1998 expression	$S_d(T_1)$ m/s ²	1.265	1.265	0.506	0.506
	Period (s)	0.727	0.727	0.727	0.727

Total Mass of the Building

The inertia effects of the design seismic action shall be evaluated by taking into account the presence of the masses associated to all gravity loads appearing in the following combination of actions (Clause 3.2.4 of [8]): $G_k + \psi_{Ei}Q_k$

Where: $\psi_{Ei} = \varphi \psi_{2i}$ $\psi_{2i} = 0.3$

The coefficient φ is equal to (Clause 4.2.4 and table 4.2 of [8]): $\varphi = 1$

The detailed calculation is given only for Case 2 high seismicity – composite columns. The mass unit is kg (for simplification, we consider that a mass of one kg corresponds to a gravitational force of 10N).

Dead load of slabs, G_{slab} .

Total floor area of the building: $24 \times 21 = 504 \text{ m}^2$

$G_{slab} = 500 \text{ kg/m}^2 \times 504 \text{ m}^2 = 252 \cdot 10^3 \text{ kg /storey}$

Self-weight of walls and partitions, G_{walls} .

Total length of one level; $21 \text{ m} \times 5 + 24 \text{ m} \times 4 = 201 \text{ m}$

$G_{walls} = 300 \cdot 201 = 60300 \text{ kg / storey}$

Self-weight of steel structural elements, G_{steel} .

Column HEA320 : $3.5 \text{ m} \times 20 \times 97.6 \text{ Kg/m} = 6832 \text{ kg /storey}$

X-Beam IPE330 : $7 \text{ m} \times 3 \times 5 \times 49.1 \text{ Kg/m} = 5155.5 \text{ kg /storey}$

Y-Beam IPEA330 : $6 \text{ m} \times 4 \times 4 \times 43 \text{ Kg/m} = 4128 \text{ kg /storey}$

Secondary beam IPE220: $6 \text{ m} \times 3 \times 4 \times 26.2 \text{ Kg/m} = 1886.4 \text{ kg /storey}$

So: $G_{steel, total} = 6832 + 5155.5 + 4128 + 1886.4 = 18002 \text{ kg /storey}$

Self-weight of concrete in composite columns, G_{concrete} .

$$G_{\text{concrete}} = (b \times h - A) \times 3.5 \text{ m} \times 5 \times 4 \times 2400 \text{ kg/m}^3$$

$$= (0.3 \text{ m} \times 0.31 \text{ m} - 12.44 \cdot 10^{-3} \text{ m}^2) \times 3.5 \text{ m} \times 5 \times 4 \times 2400 \text{ kg/m}^3 = 13534 \text{ kg /storey}$$

Where b, h and A are width, height and area of the steel profile of the column

Total dead load of the building, G:

$$G = G_{\text{saib}} + G_{\text{walls}} + G_{\text{steel}} + G_{\text{concrete}} = 5 \cdot (252000 + 60300 + 18002 + 13534) = 1719.2 \cdot 10^3 \text{ kg}$$

$$\text{Imposed load, } Q_{\text{imposed}} = 300 \text{ kg/ m}^2 \times 504 \text{ m}^2 = 151200 \text{ kg /storey}$$

$$\text{Snow load, } Q_{\text{snow}} = 110 \text{ kg/ m}^2 \times 504 \text{ m}^2 = 55440 \text{ kg /storey}$$

$$\text{Total live load of the building: } Q = 5 \times 151200 + 55440 = 811.5 \cdot 10^3 \text{ kg}$$

$$\text{Total mass of the building, } m = G + \psi_{\text{Ei}} Q = 1719200 + 0.3 \times 811500 = 1963 \cdot 10^3 \text{ kg}$$

	Case1	Case2	Case3	Case4
Seismic mass of the building (tons)	1900	1963	1916	1994

Determination of Seismic Base Shear Force by the Lateral Force Method of Analysis

According to structure regularity in plan and elevation, we use the equivalent static lateral force method for the linear-elastic analysis (clause 4.2.3.1 and table 4.1 of [8]) provided that the clause 4.3.3.2.1(2) of [8] is satisfied.

The detailed calculation is given only for Case 2 high seismicity – composite columns

The seismic base shear force (F_b), acting on the whole structure, for the horizontal direction in which the building is analysed, is determined as follows (clause 4.3.3.2.2(1) of [8]):

$$F_b = m \cdot S_d(T_1) \cdot \lambda$$

$$F_b = 1963 \cdot 0.535 \cdot 0.85$$

$$F_b = 892 \text{ kN}$$

Where m is total mass of the building and λ is the correction factor which is equal to 0.85

$$\text{The seismic base shear force, } F_{bX}, \text{ applied on each MR frame is } F_{bX} = \frac{F_b}{5} = \frac{892}{5} = 178.4 \text{ kN}$$

We take into account the torsion by amplifying the base shear force, F_{bX} , by the factor δ (clause

$$\delta = 1 + 0.6 \cdot \frac{x}{L}$$

$$4.3.3.2.4 \text{ of [8]): } \delta = 1.3$$

$$\text{Where: } L = 6 \cdot 4 = 24 \text{ m} \quad x = 0.5 \cdot L = 12 \text{ m}$$

So, the total seismic base shear force (F_{bXt}), acting on each MR frame, by taking torsion effects into

$$F_{bXt} = \delta \cdot F_{bX}$$

account is:

$$F_{bXt} = 1.3 \cdot 178.4$$

$$F_{bXt} = 232 \text{ kN}$$

The horizontal seismic forces acting on building stories are determined by the following expression

(clause 4.3.3.2.3(2) of [8]) :
$$F = F_{bXt} * \frac{s_i m_i}{\sum s_j m_j}$$

$F_1 = 15.46 \text{ kN}$ $F_2 = 30.93 \text{ kN}$ $F_3 = 46.39 \text{ kN}$
 $F_4 = 61.86 \text{ kN}$ $F_5 = 77.32 \text{ kN}$

Seismic static equivalent forces	Case1	Case2	Case3	Case4
E1 (kN)	15.70	15.46	7.69	7.67
E2 (kN)	31.40	30.93	15.39	15.33
E3 (kN)	47.10	46.39	23.08	23.00
E4 (kN)	62.79	61.86	30.77	30.66
E5 (kN)	78.49	77.32	38.46	38.33

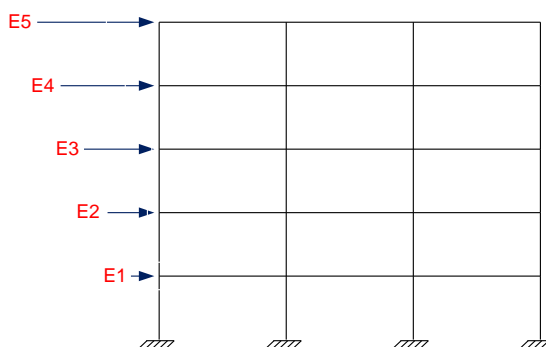

Fig. 5.16.2 Distribution of seismic loads

5.16.4 COMBINATIONS OF ACTIONS FOR SERVICEABILITY LIMIT STATE DESIGN

Combinations of actions for quasi-permanent actions, and the general format of effects of actions at SLS (service limit state) is written as (Annex A₁, clause A₁.4.1 (1) and table A₁.4 of [7]):

$$G_{kj,sup} + G_{kj,inf} + \psi_{2,1} Q_{k,1} + \psi_{2,i} Q_{k,i}$$

Where G_i and Q_i are defined at clause 3.5.1 of this chapter. For serviceability limit states, the partial factors for actions should be taken as 1.0 (Annex A₁, clause A₁.4.1 (1) of [7]), we thus use the following critical combination at SLS: $G+Q$ where G and Q are dead and imposed loads respectively.

5.16.5 COMBINATIONS OF ACTIONS FOR ULTIMATE LIMIT STATE DESIGN

Fundamental Combinations

Combinations of actions for persistent or transient design situations are called fundamental combinations and the general format of effects of actions at ULS (ultimate limit state) is written as (Annex A₁, clause A₁.3.1 and table A₁.2 (B) of [7]): $\gamma_{Gj,sup} G_{kj,sup} + \gamma_{Gj,inf} G_{kj,inf} + \gamma_{Q,1} Q_{k,1} + \gamma_{Q,i} \psi_{0,i} Q_{k,i}$

Where:	And:
$G_{kj,sup}$: Unfavorable permanent action	$\gamma_{Gj,sup} = 1.35$
$G_{kj,inf}$: Favorable permanent action	$\gamma_{Gj,inf} = 1$
$Q_{k,1}$: Leading variable action	$\gamma_{Q,1} = 1.50$ where unfavorable
$Q_{k,i}$: Accompanying variable action	$= 0$ where favorable

For an office building of type B, the combinations at ULS considered in the analysis are:

$1.35G + 1.5W + 1.05Q + 0.75S$	Where:	G : Dead load
$1.35G + 1.5W + 1.05S + 0.75Q$		Q : Imposed load
$1.35G + 1.5Q + 1.05W + 0.75S$		S : Snow load
$1.35G + 1.5Q + 1.05S + 0.75W$		W : Wind load
$1.35G + 1.5W + 1.05(S + Q)$		
$1.35G + 1.5(S + Q) + 1.05W$		

Combinations of Actions for Seismic Design Situation

To perform the verification of structure design at ULS and for a building type B, the following combination of permanent and variable actions in seismic design situation (clause 6.4.3.4(2) of [7]) is considered: $G_k + \psi_2 Q_k + E$ where E represents the seismic design load and $\psi_2 = 0.3$

Final critical Load Combinations

To perform the verification of structure design at ultimate limit state method (ULS), we adopt the following two critical load combinations in persistent, transient and seismic design situations:

Persistent and Transient Design Situations	Seismic Design Situation
$1.35G + 1.5(S + Q) + 1.05W$	$G_k + \psi_2 Q_k + E$ with $\psi_2 = 0.3$

5.16.6 ACTIONS ON MR FRAMES

Persistent and Transient Design Situations

Figure 5.16.3 shows the distribution of wind and gravitational loads on MR frames in persistent and transient design situations.

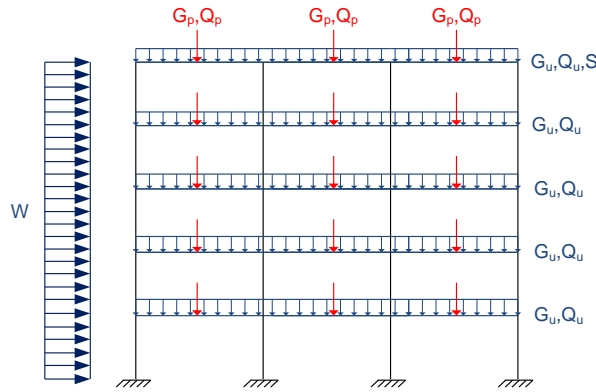

Fig. 5.16.3 Distribution of loads

Where:

G_u = Uniform dead load	= 16.3 kN/m
G_c = Concentrated dead load	= 55.8 kN
Q_u = Uniform imposed load	= 8.0 kN/m
Q_c = Concentrated imposed load	= 33.5 kN

Seismic Design Situation

Figure 5.16.4 shows the distribution of seismic design loads on MR frames in seismic design situation. Seismic actions (E_i) are given for all cases of building design.

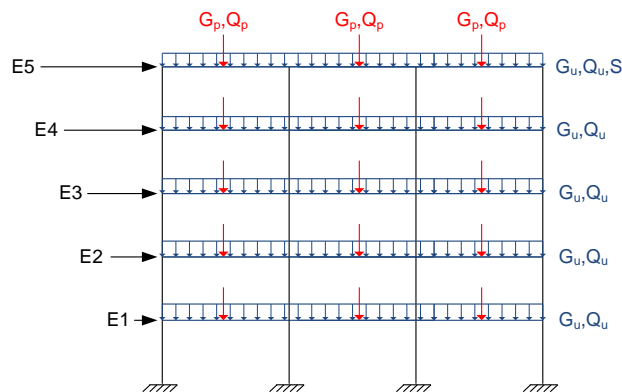

Fig. 5.16.4 Distribution of loads

5.17 Stages of Preliminary Design

The preliminary design consists of the following (Clause 15.1 of [9]):

At first, we check the sections of beams for deflection and resistance under the gravity loads.

Then, we perform the following steps of calculation iteratively to meet all criteria of the design.

5.17.1 ASSUMPTIONS

A 2D-linear elastic analysis was carried out using the FINELG software. This analysis has been used primarily for the preliminary design of the structure: it also provides information on the elastic dynamic characteristics of the structure like the fundamental period of vibration.

Class sections of structural elements and effective column length are shown in section 5.17.2.

Effective width of composite beam are calculated in section 5.17.5.

In beams, two different flexural stiffnesses are defined (clause 7.7.2(3) of **[8]**) as:

EI_1 for the part of the spans submitted to positive (sagging) bending (uncracked section)

EI_2 for the part of the span submitted to negative (hogging) bending (cracked section).

The analysis was performed considering for the entire beam an equivalent second moment of area I_{eq} and a cross-section area constant for the entire span (clause 7.7.2 (3) of **[8]**):

$$I_{eq} = 0.6 I_1 + 0.4 I_2 \quad A_{eq} = 0.6 A_1 + 0.4 A_2$$

For composite columns, the stiffness and area are given by (clause 7.7.2 (4) of **[8]**):

$$EI = 0.9(E_a I_a + 0.5 E_c I_c + E_a I_s)$$

$$A = 0.9(A_a + 0.5 \frac{A_c}{7} + A_s)$$

The partial factors γ_{Mi} , applied to the various characteristic values of resistance, are given as (Clause 6.1/Note 2B of **[12]**); $\gamma_{M0} = 1.0$ for the resistance of cross-sections to excessive yielding including local buckling; $\gamma_{M1} = 1.0$ for resistance of members to member buckling.

The values of partial factors, γ_C and γ_S , of materials for the persistent and transient design situations are found from the EN 19921-1 (clause 5.2.4 of **[13]**).

The partial coefficients of materials, for the ultimate limit state, for persistent and transient situations are given as (Clause 2.4.2.4 and table 2.1N of **[13]**); $\gamma_S = 1.15$ for reinforcing steel; $\gamma_C = 1.5$ for concrete.

The recommended values of γ_C and γ_S in the serviceability limit state, for deflection check, are equal to 1.0 (Clause 2.4.2.4(1) of **[13]**).

The modulus of elasticity of concrete, E_C , is controlled by its strength class (clause 3.1.2 and table 3.1 of **[13]**). In case of high seismic zones (cases 1 and 2), and for a concrete of class C30/37, $E_C = 33.10^3 \text{ N/mm}^2$. In case of low seismic zones (cases 3 and 4), and for a concrete of class C25/30, $E_C = 31.10^3 \text{ N/mm}^2$

The modulus of elasticity of reinforcing steel and profile steel, E_a , is equal to 210.10^3 N/mm^2 . For persistent and transient design situations the effects of creep in composite beams may be taken into account by replacing concrete areas A_c by effective equivalent steel areas (A_c/n) for both short-term and long-term loading, where ($n = E_a/E_{cm}$) is the nominal modular ratio corresponding to an effective modulus of elasticity for concrete E_c taken as ($E_{cm}/2$) (clause 5.4.2.2(11) of **[10]**). But in this report we took $n = 6$ and 18 for short-term and long-term loading respectively.

For seismic design situations, the stiffness of composite sections in which the concrete is in compression is computed using a modular ratio n (clause 7.4.2(1) of **[8]**): $n = E_a/E_{cm} = 7$

The elastic coefficient of equivalence, $n_{el} = E_a / E_C \approx 6$.

The plastic coefficient of equivalence for the profile steel, n_{pl} :

$$n_{pl} = \frac{f_y \cdot \gamma_c}{0.85 f_{ck} \cdot \gamma_M}$$

$$n_{pl} = \begin{cases} 20.90 & \text{(Cases 1 and 2)} \\ 16.60 & \text{(Cases 3 and 4)} \end{cases}$$

The plastic coefficient of equivalence for the reinforcing steel, n_{pls} :

$$n_{pls} = \frac{f_y \cdot \gamma_s}{f_{sk} \cdot \gamma_M}$$

$$n_{pls} = \begin{cases} 0.82 & \text{(Cases 1 and 2)} \\ 0.60 & \text{(Cases 3 and 4)} \end{cases}$$

5.17.2 DESIGN

In this section, we display the structural analysis and design results for all cases. Structural cross-sections. Figures 5.17.1, 5.17.2 and 5.17.3 describe the cross-section of composite beams and columns for all cases.

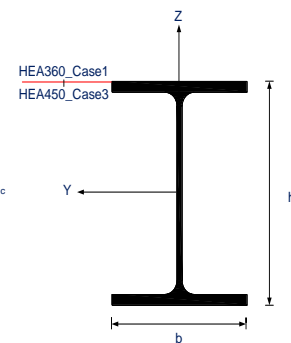
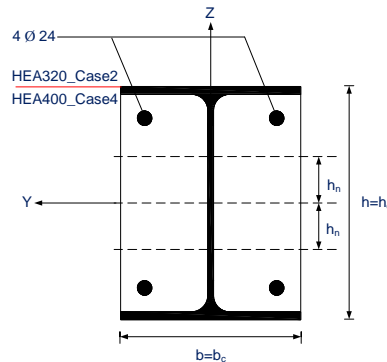
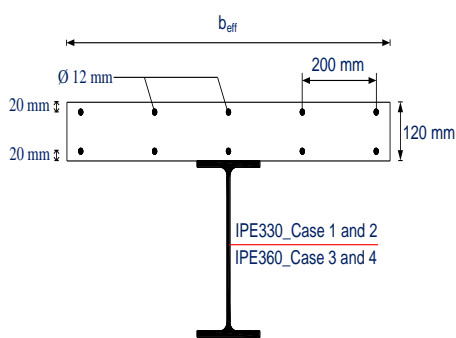

Fig. 5.17.1 Composite beams

Fig. 5.17.2 Composite columns

Fig. 5.17.3 Steel columns

The steel profiles resulting from structure design, in all four cases, are defined in the Figures 5.17.4 and 5.17.5. Left of column axis and above beams: steel columns correspond to low and high seismicity, case 1 and 3. Right of column axis and below beams correspond to composite columns, low and high seismicity, case 2 and 4.

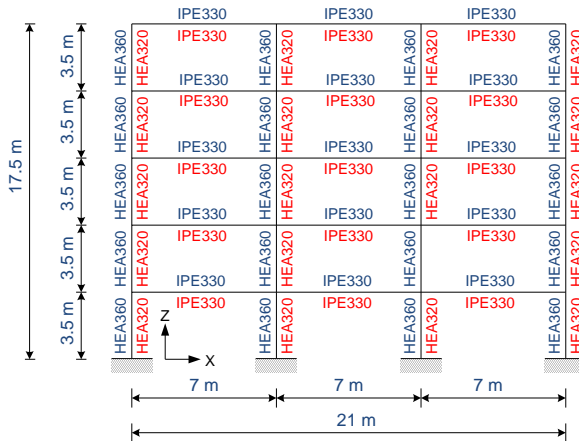

Fig. 5.17.4 High seismicity (Cases 1 and 2)

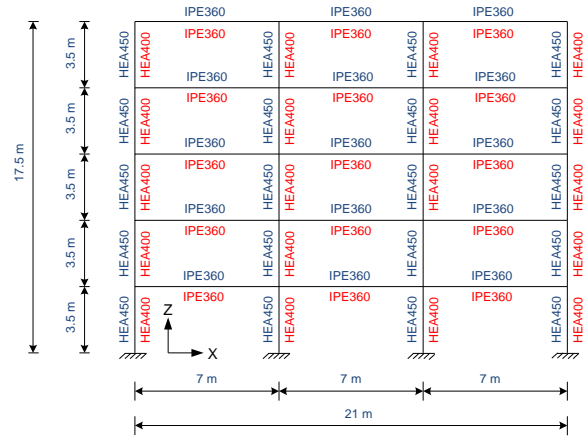

Fig. 5.17.5 Low seismicity (Cases 3 and 4)

Classes of steel section

Eurocode EN 1998 (section 6.1.2 and 7.1.2 for steel and composite structures) requirements depend on the value of selected behaviour factor:

Class 1 for $4.0 < q$. (For high dissipative structural behaviour)

Class 2 for $2.0 < q \leq 4$. (For medium dissipative structural behaviour)

Class 3 for $1.5 < q \leq 2$. (For low dissipative structural behaviour)

Class sections of structural elements are as follows:

Composite Beams

For composite beams, (clause 5.5.1(1) of [10]) and (clause 5.6 and table 5.2 of [12]), we have:

Flange subject to compression:

$$\frac{c}{t_f} = \frac{(0.5b - r - 0.5t_w)}{t_f} = \frac{(0.5 * 170 - 18 - 0.5 * 8)}{12.7}$$

$$\Rightarrow \frac{c}{t_f} = \begin{cases} 5.07 & \text{(IPE330)} \\ 4.96 & \text{(IPE330)} \end{cases} < \begin{cases} 9\epsilon = 9 * \sqrt{\frac{235}{355}} = 7.32 & \text{(IPE330)} \\ 9\epsilon = 9 * \sqrt{\frac{235}{235}} = 9.00 & \text{(IPE360)} \end{cases}$$

\Rightarrow flanges are classified into class 1

Web subject to bending and compression:

$$c = h_a - 2t_f - 2r = \begin{cases} 271.0 \text{ mm (IPE330)} \\ 298.6 \text{ mm (IPE360)} \end{cases}$$

$$\alpha = \frac{(Z_b - t_f - r)}{c} = \begin{cases} 0.909 \text{ (IPE330)} \\ 0.994 \text{ (IPE360)} \end{cases}$$

Since $\alpha > 0.5$:

$$\frac{c}{t_w} = \begin{cases} 36.133 \text{ (IPE330)} \\ 37.325 \text{ (IPE360)} \end{cases} > 396 \frac{\varepsilon}{(13\alpha - 1)} = \begin{cases} 29.802 \text{ (IPE330)} \\ 33.217 \text{ (IPE360)} \end{cases}$$

\Rightarrow Webs are classified into class 2

So composite beams of steel sections IPE330 and IPE360 belong to class 2.

Steel Columns

For steel columns, which are subjected to axial force and bending, we can always consider the worst case where the elements are subjected to compression only (clause 5.6 and table 5.2 of [12]), we have:

Flange subject to compression:

$$\frac{c}{t_f} = \frac{(0.5b - r - 0.5t_w)}{t_f} = \begin{cases} 6.74 < 9\varepsilon = 7.29 \text{ (HEA360)} \\ 5.58 < 9\varepsilon = 9.00 \text{ (HEA450)} \end{cases}$$

\Rightarrow flanges are classified into class 1

Web subject to compression:

$$\frac{c}{t_w} = \frac{h - 2t_f - 2r}{t_w} = \begin{cases} 26.10 < 33\varepsilon = 27 \text{ (HEA360)} \\ 29.91 < 33\varepsilon = 33 \text{ (HEA450)} \end{cases}$$

\Rightarrow Webs are classified into class 1

Steel columns of sections HEA360 and HEA450 belong to class 1.

Composite Columns

For composite columns, (clause 5.5.3(1) and table 5.2 of [10]) or (clause 7.6.4(8) and table 7.3 of [8]):

Flange subject to compression:

$$\frac{c}{t_f} = \frac{(0.5b - r - 0.5t_w)}{t_f} = 6.74 < 9\varepsilon = 7.29 \text{ (HEA360 Case2)}$$

$$\frac{c}{t_f} = 6.18 < 9\varepsilon = 9 \text{ (HEA400 Case4)}$$

\Rightarrow flanges are classified into class 1

It is assumed that the concrete (that encases the web of steel sections) is capable of preventing buckling of the web and any part of the compression flange towards the web (clause 5.5.3(2) of [10]). As a result, composite columns of steel sections HEA320 and HEA400 belong to class 1.

Effective Column Length

The effective column length (buckling length) is calculated as $L_{cr}=KL$. Where the buckling coefficient K is the ratio of the effective column length to the unbraced length L . Values of K depend on the support conditions of the column to be designed, and the design values of K for use with idealized conditions of rotation and translation at column supports are illustrated in Fig. E.2.1 of Annex E (Clause E.2 of [16]). For example, we take $K=0.5$ for columns fixed at both ends, $K=1$ for columns simply supported at both ends and $K=0.7$ for columns simply supported at one end and fixed at the other. in this report, for more safety, we took $K=1$.

Hence, the buckling length, L_{cr} : $L_{cr} = 3.5 \text{ m}$ (= storey height)

Axial Force and Bending Moment Diagrams

Axial force and bending moment diagrams for the critical load combinations at ULS are shown in Figures 5.17.6 to 5.17.9.

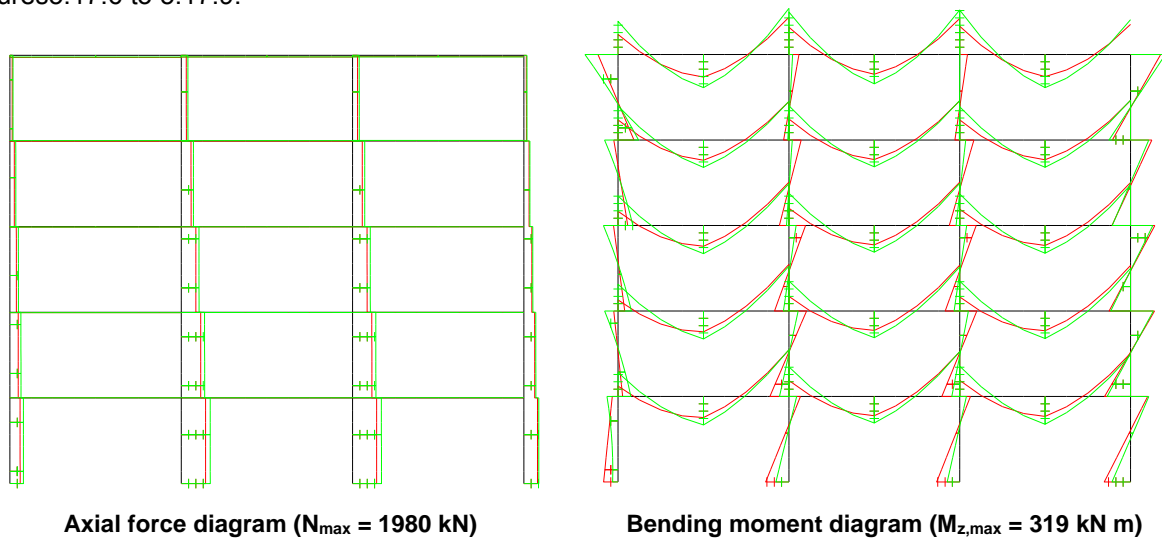

Fig. 5.17.6 Case 1: high seismicity – steel columns

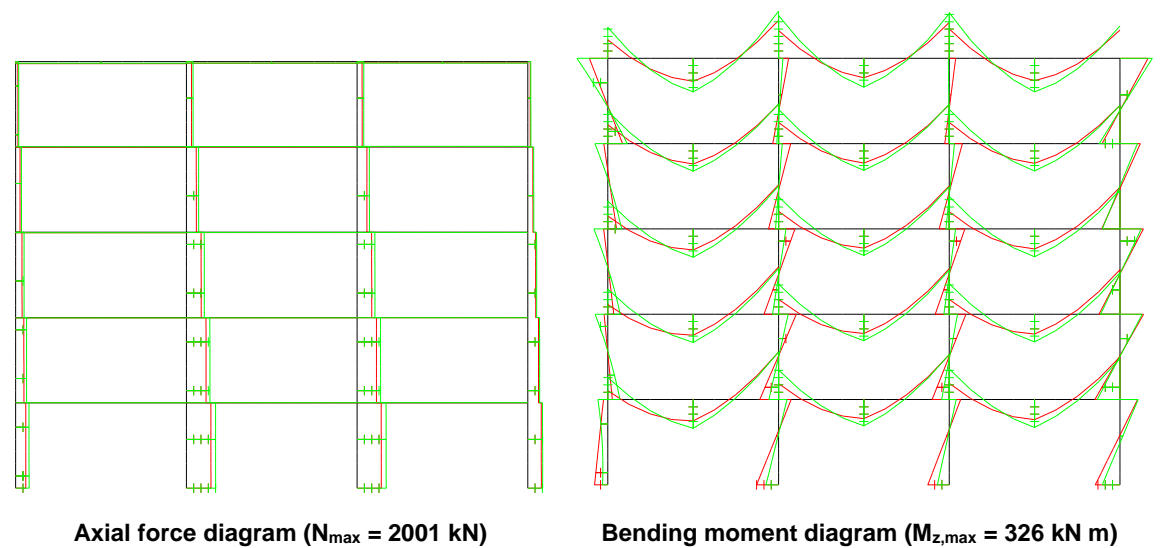

Fig. 5.17.7 Case 2: high seismicity – composite columns

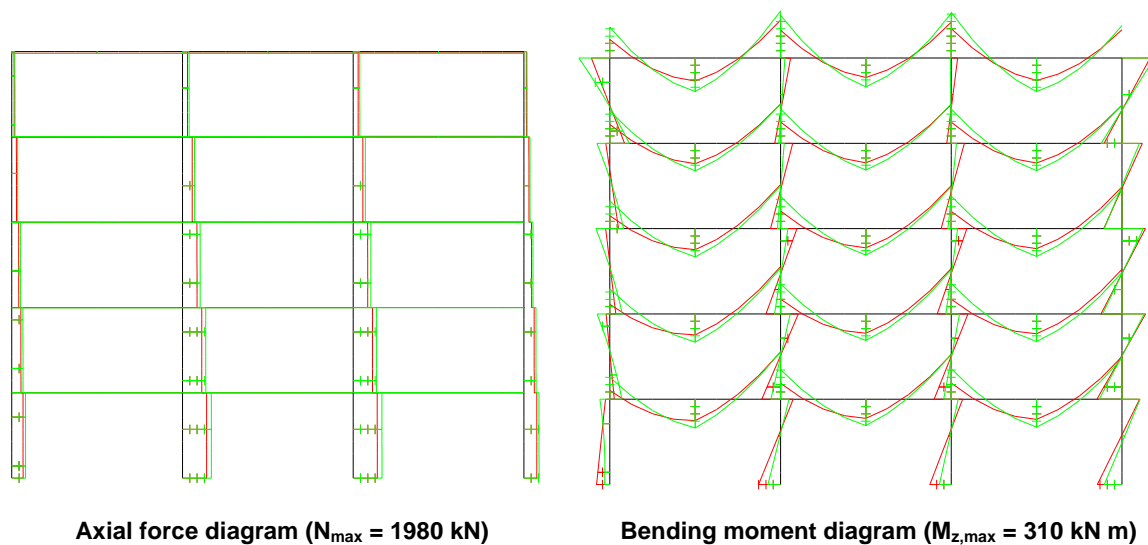

Fig. 5.17.8 Case 3: low seismicity – steel columns

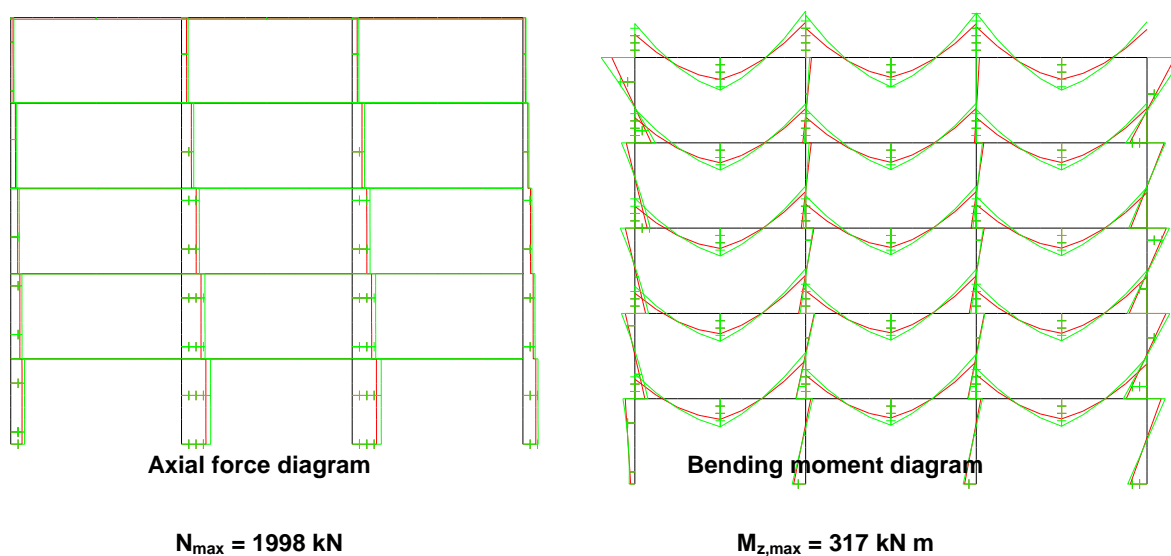

Fig. 5.17.9 Case 4: low seismicity – composite columns

Maximum Internal Forces and Moments

Figures 5.17.10 and 5.17.11 show the number of finite elements in which the maximum internal efforts are acting. For convenience, beams and columns are numbered in Figures 5.17.10 and 5.17.11 where B and C represent Beam and Column respectively.

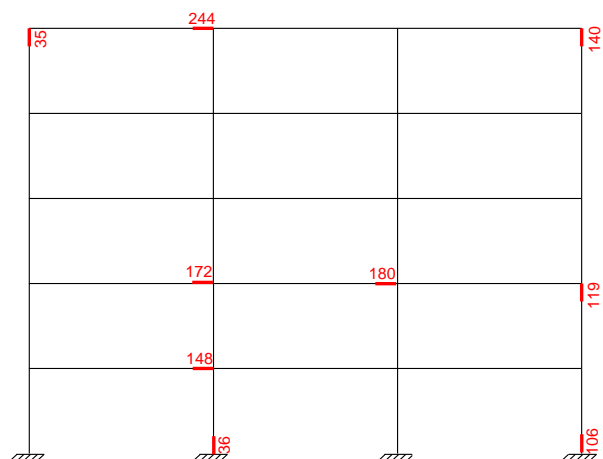

Fig. 5.17.10 Number of elements which are subjected to maximum internal efforts

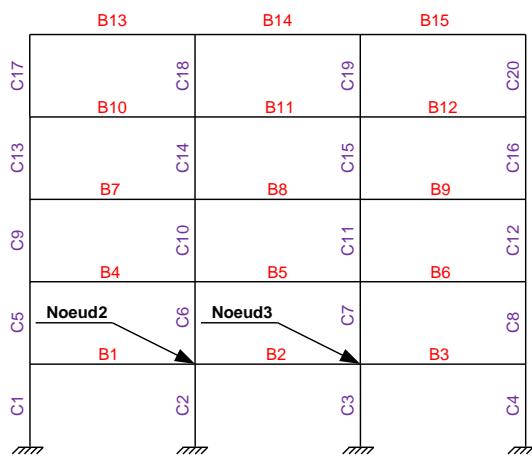

Fig. 5.17.11 Number of beams and columns

For seismic design situations, the maximum forces and bending moments in columns are computed as follows (clause 6.6.3(1) of [8]):

$$N_{Ed}^* = N_{Ed,G} + 1,1\gamma_{ov}\Omega N_{Ed,E}$$

$$M_{Ed}^* = M_{Ed,G} + 1,1\gamma_{ov}\Omega M_{Ed,E}$$

$$V_{Ed}^* = V_{Ed,G} + 1,1\gamma_{ov}\Omega V_{Ed,E}$$

$N_{Ed,E}$, $M_{Ed,E}$ and $V_{Ed,E}$ are multiplied by $(1/(1-\theta))$ where second order effects have to be taken into account. For seismic design situations, the maximum forces and bending moments in beams had been computed in the pre design following:

$$N_{Ed}^* = N_{Ed,G} + N_{Ed,E}$$

$$M_{Ed}^* = M_{Ed,G} + M_{Ed,E}$$

$$V_{Ed}^* = V_{Ed,G} + V_{Ed,E}$$

$N_{Ed,E}$, $M_{Ed,E}$ and $V_{Ed,E}$ are multiplied by $(1/(1-\theta))$ where second order effects have to be taken into account. The tables hereunder summarize the maximum internal effects from the structural analysis:

Axial forces

Maximum axial forces (kN) for the critical fundamental combination								
	Case 1		Case 2		Case 3		Case 4	
		Element		Element		Element		Element
Beams	120	244_B13	114	244_B13	127	244_B13	121	244_B13
columns	1979	36_C2	2001	36_C2	1975	36_C2	1998	36_C2

Maximum axial forces (kN) for the seismic combination								
	Case 1		Case 2		Case 3		Case 4	
		Element		Element		Element		Element
Beams	149	244_B13	142	244_B13	120	244_B13	115	244_B13
columns	1666	36_C2	1687	36_C2	1655	36_C2	1674	36_C2

Shear forces

Maximum shear forces (kN) for the critical fundamental combination								
	Case 1		Case 2		Case 3		Case 4	
		Element		Element		Element		Element
Beams	234	244_B13	237	244_B13	231	244_B13	234	244_B13
columns	120	35_C17	114	35_C17	127	35_C17	121	35_C17

Maximum shear forces (kN) for the seismic combination								
	Case 1		Case 2		Case 3		Case 4	
		Element		Element		Element		Element
Beams	196	148_B1	199	172_B4	178	244_B13	180	244_B13
columns	127	119_C8	124	119_C8	95	140_C20	93	140_C20

Bending moments

Maximum bending moments (kN.m) for the critical fundamental combination								
	Case 1		Case 2		Case 3		Case 4	
		Element		Element		Element		Element
Beams	319	148_B1	326	148_B1	310	148_B1	317	244_B13
columns	238	140_C20	222	140_C20	258	140_C20	244	140_C20

Maximum bending moments (kN.m) for the seismic combination								
	Case 1		Case 2		Case 3		Case 4	
		Element		Element		Element		Element
Beams	324	172_B4	330	172_B4	257	180_B5	262	148_B1
columns	272	106_C4	250	106_C4	218	140_C20	206	140_C20

Maximum Plastic Resistance of Sections

Tables show the plastic section resistance of beams and columns taken in the preliminary design.

High seismicity (cases 1 and 2):

	Plastic axial force $N_{pl,Rd}$ (kN)	Plastic shear force $V_{pl,rd}$ (kN)	Plastic bending moment $M_{pl,Rd}$ (kN.m)			
			Eurocode4		Eurocode8	
			positive	negative	positive	negative
Composite Beam IPE330	5767	631	515	342	495	393

	Plastic axial force $N_{pl,Rd}$ (kN)	Plastic shear force $V_{pl,rd}$ (kN)	Plastic bending moment $M_{pl,Rd}$ (kN.m)
Steel column HEA360	5069	1003	741
Composite column HEA320	6542	843	660

Low seismicity (cases 3 and 4):

	Plastic axial force $N_{pl,Rd}$ (kN)	Plastic shear force $V_{pl,rd}$ (kN)	Plastic bending moment $M_{pl,Rd}$ (kN.m)			
			Eurocode4		Eurocode8	
			positive	negative	positive	negative
Composite Beam IPE360	4708	477	428	317	415	337

	Plastic axial force, $N_{pl,Rd}$ (kN)	Plastic shear force, $V_{pl,rd}$ (kN)	Plastic bending moment $M_{pl,Rd}$ (kN.m)
Steel column HEA450	4183	893	756
Composite column HEA400	5851	778	718

5.17.3 SECOND-ORDER EFFECTS

Based on the Eurocode 8-1, the value of interstorey drift sensitivity coefficient (θ) is calculated

according the following expression (clause 4.4.2.2(2) of [8]): $\theta = \frac{P_{tot} * d_r}{V_{tot} * h} \leq 0.1$

where P_{tot} is the total gravity load at and above the storey considered in the seismic design situation, V_{tot} is the total seismic storey shear and h is the interstorey height. The Eurocode 8-1 states that d_r is the real relative displacement, i.e. inelastic displacement, evaluated as the difference of average lateral displacements (d_s) at top and bottom of the storey under consideration and calculated by multiplying the elastic displacement (d_e), induced by a linear analysis based on design seismic action, by the displacement behavior factor (q) (clause 4.3.4 of [8]):

$$d_r = d_{s(i+1)} - d_{s(i)} = q [d_{e(i+1)} - d_{e(i)}]$$

If ($0.1 < \theta \leq 0.2$), the second-order effects may approximately be taken into account by multiplying the relevant seismic action effects by a factor equal to $1 / (1 - \theta)$ (clause 4.4.2.2(3) of [8]), and the structural design can be done by a linear elastic analysis.

If ($0.2 < \theta \leq 0.3$), the structure is designed according to a plastic non-linear analysis (Pushover analysis). The value of the coefficient θ shall not exceed 0.3 (clause 4.4.2.2(4) of [8]).

Eurocode 3-1 replaces the sensitivity coefficient, θ , by a the factor ($1 / \alpha_{cr}$) where α_{cr} is the factor by which gravity loads should be multiplied to check elastic instability of the structure (clause 5.2.1(3) of [12]).

For elastic analysis: $\alpha_{cr} \geq 10$ and ($1 / \alpha_{cr}$) ≤ 0.10 which corresponds to the criterion of the Eurocode 8-1 (clause 4.4.2.2(2) of [8]), $\theta \leq 0.10$.

For plastic analysis: $\alpha_{cr} \geq 15$ which corresponds to the criterion $\theta \leq 0.065$

But according to Eurocode3-1, ARIBERT [17] considers that d_r is a displacement of elastic type, even when a plastic analysis is used for calculating the stresses in structures. And the static equivalent analysis of Eurocode 8-1 is finally being checked with the following expression (clause 6 of [14]):

$$\theta = \frac{P_{tot} * d_r^e}{V_{tot} * h} \leq 0.065$$

However, it is reasonable to know that the value of θ could be a little more intricate than in Eurocode 3, taking into account the cyclic and the hysteric behaviour of the plastic dissipation. So ARIBERT [17] proposed the following relationship to check P- Δ effects in seismic design situations:

$$\theta = \frac{P_{tot} * d_r^e}{V_{tot} * h} \leq 0.045$$

The tables, shown below, provide the numerically obtained values of θ showing that the effects of the 2nd order, P- Δ effects, may be neglected for cases 3 and 4. But for cases 2 and 4 where θ exceeds the value of 0.045 at second storey level, the second-order effects are taken into account by multiplying the seismic action effects at second storey level by a factor equal to $1/(1 - \theta)$.

where :

$$\frac{1}{1-\theta} = \begin{cases} \frac{1}{1-0.048} = 1.050 & (\text{Case1}) \\ \frac{1}{1-0.054} = 1.060 & (\text{Case2}) \end{cases}$$

Case 1: high seismicity – steel columns

Storey N°.	d_e [m]	d_r^e [m]	V [kN]	V_{tot} [kN]	P_{tot} [kN]	θ
1	0.007	0.007	15.70	235.48	3799.96	0.032
2	0.019	0.012	31.40	219.78	3046.62	0.048
3	0.030	0.011	47.10	188.38	2293.28	0.038
4	0.038	0.008	62.79	141.28	1539.94	0.025
5	0.044	0.006	78.49	78.49	786.60	0.017

Case 2: high seismicity – composite columns

Storey N°.	d_e [m]	d_r^e [m]	V [kN]	V_{tot} [kN]	P_{tot} [kN]	θ
1	0.008	0.008	15.46	231.96	3925.22	0.039
2	0.021	0.013	30.93	216.50	2146.83	0.057
3	0.032	0.011	46.39	185.57	2368.44	0.040
4	0.041	0.009	61.86	139.18	1590.05	0.029
5	0.046	0.005	77.32	77.32	811.66	0.015

Case 3: low seismicity – composite columns

Storey N°	d_e [m]	d_r^e [m]	V [kN]	V_{tot} [kN]	P_{tot} [kN]	θ
1	0.002	0.002	7.69	115.39	3831.21	0.019
2	0.006	0.004	15.39	107.7	3071.62	0.033
3	0.010	0.004	23.08	92.31	2312.03	0.029
4	0.013	0.003	30.77	69.23	1552.44	0.019
5	0.015	0.002	38.46	38.46	792.85	0.012

Case 4: low seismicity – composite columns

Storey N°	d_e [m]	d_r^e [m]	V [kN]	V_{tot} [kN]	P_{tot} [kN]	θ
1	0.002	0.002	7.67	114.99	3987.31	0.020
2	0.007	0.005	15.33	107.32	3196.5	0.043
3	0.010	0.003	23.00	91.99	2405.69	0.022
4	0.013	0.003	30.66	68.99	1614.88	0.020
5	0.016	0.003	38.33	38.33	824.07	0.018

5.17.4 DAMAGE LIMITATION

We must verify at this stage whether the damage limitations of non-structural elements are satisfied (clause 4.4.3.2(c) of [8]): $d_r * v \leq 0.010h$ with $dr = q * d_r^e$

Where v is the reduction factor, for taking into account the lower return period of the seismic action associated with the damage limitation requirement, $v = 0.5$ for a building of an importance class II. And the other parameters are defined previously. The values, shown in table below, show that the precedent inequality is well satisfied and the interstorey drifts are limited.

Storey N°	$d_r * v$ (m)				0.010h (m)
	Case1	Case2	Case3	Case4	
1	0.014	0.016	0.004	0.004	0.035
2	0.024	0.026	0.008	0.010	0.035
3	0.022	0.022	0.008	0.006	0.035
4	0.016	0.018	0.006	0.006	0.035
5	0.012	0.010	0.004	0.006	0.035

5.17.5 SECTION AND STABILITY CHECKS OF COMPOSITE BEAMS

The composite beam is defined in Figure 5.17.12, and the steel profiles are IPE330 and IPE360 for high seismic zones (cases 1,2) and low seismic zones (cases 3,4) respectively. Mechanical characteristics are given as follows:

High seismicity Cases 1 and 2 : Profiles S355, Steel reinforcement BAS500, Concrete C30/37

Low seismicity Cases 3 and 4 : Profiles S235, Steel reinforcement BAS450, Concrete C25/35

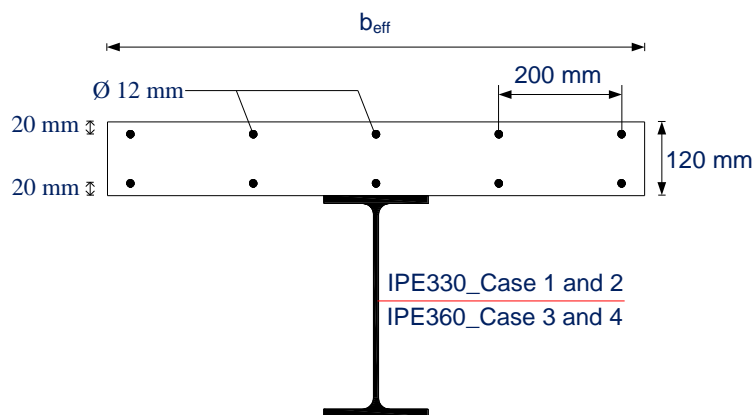

Fig. 5.17.12 Composite beam definition

Effective Width

For performing calculations according to the Eurocode 4-1 in persistent and transient design situations, the total effective width, as shown in figure below, may be determined as (clause 5.4.1.2(5) of [10]):

$$b_{eff} = b_0 + \sum b_{ei}$$

$$b_{eff} = \begin{cases} 1225 \text{ mm} & \text{(at mid-span)} \\ 875 \text{ mm} & \text{(at an end support)} \end{cases}$$

b_0 is the distance between the centres of the outstand shear connectors and it is assumed to be Zero in our example.

b_{ei} is the value of the effective width of the concrete flange on each side of the web and taken as $(L_e / 8)$ but not greater than the geometric width b_i , where the length of the equivalent span (L_e) may be assumed to be as shown in Figure 5.17.13 and in the table below.

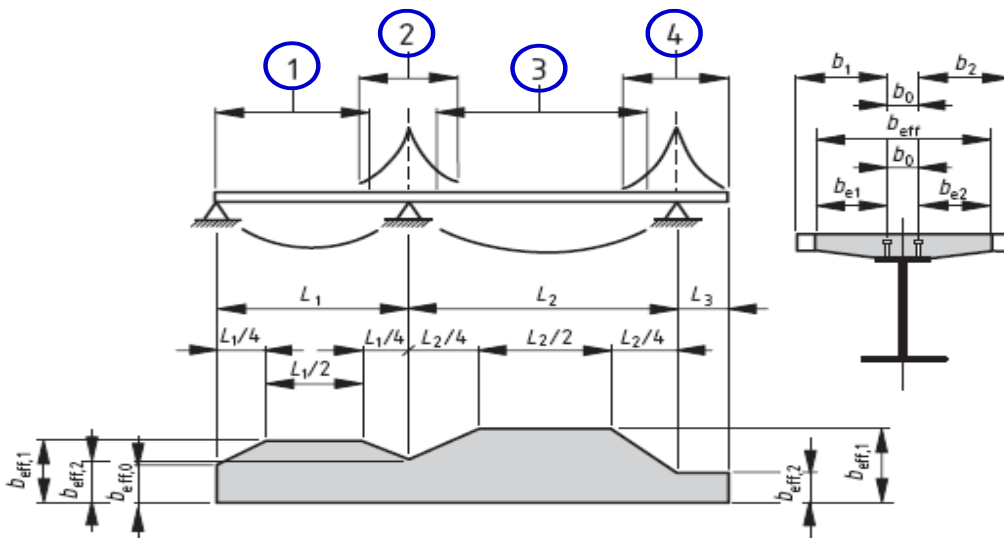

Fig. 5.17.13 EN 1994 definition of effective width.

	Positive Moment		Negative Moment	
	b_{eff1}	b_{eff3}	b_{eff2}	b_{eff4}
Effective Length (L_e Formula)	0.85L1	0.7L2	0.25(L1+L2)	2L3

The values of effective span lengths and effective width values adopted in design are shown in Figure 5.17.14

Positive Moment	Effective span Length (L_e _mm)	0.7L2	=4900
	Effective Width (b_{eff} _mm)	$2 \cdot L_e / 8$	=1225
Negative Moment	Effective span Length (L_e _mm)	$0.25(L1+L2)$	=3500
	Effective Width (b_{eff} _mm)	$2 \cdot L_e / 8$	=875

L_1 and L_2 are the span lengths of beams and where $L_1=L_2=7000$ mm.

For performing calculations according to the Eurocode 8-1 in seismic design situations, the total effective width, as shown in figure below, may be determined as: $b_{eff} = b_{e1} + b_{e2}$

$b_{e1,2}$ and b_{eff} are calculated for elastic analysis (Clause 7.6.3 and table 7.5 of [8]) as well as for evaluation of plastic moments (Clause 7.6.3 and table 7.5II of [8]), as shown in the table below:

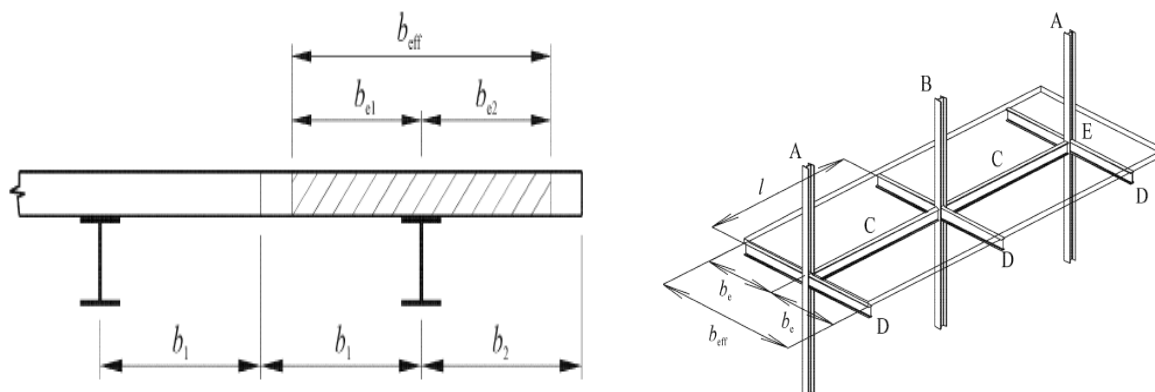

Fig. 5.17.14 EN 1998 definition of effective width

		Positive Moment	Negative Moment
Elastic analysis	b_{ei} (mm)	$0.0375L=262.5$	$0.05L=350$
	b_{eff} (mm)	$2 b_{ei}=525$	$2 b_{ei}=700$
Plastic Moments	b_{ei} (mm)	$0.075L=525$	$0.1L=700$
	b_{eff} (mm)	$2 b_{ei}=1050$	$2 b_{ei}=1400$

Integrity of the concrete slab

To maintain the integrity of the concrete slab during the seismic event, while yielding takes place in the bottom part of the steel section and/or in the rebars of the slab, the limit values of (x/d) ratio for ductility of composite beams with slab should satisfy the values given in the table below (clause 7.6.2 (1.8) and table 7.4 of [8]) :

Ductility class	q	f_y (N/mm ²)	x/d upper limit
DCM	$1.5 < q \leq 4$	355	0.27
	$1.5 < q \leq 4$	235	0.36
DCH	$q > 4$	355	0.20
		235	0,27

d is the section's height of composite beam and (x) is the difference between the top of the slab and the position of neutral axis (in case of positive moment and seismic situation).

The table below shows that the maximum values of ratio (x/d) are satisfied for all cases:

	Case1	Case2	Case3	Case4
(x/d)limit values (EC8)	0.27	0.27	0.36	0.36
(x/d)_{max} (Design values)	0.268	0.268	0.239	0.239

Deflection Check

It is supposed that beams are fixed at both ends with a span of 7 m. Applied uniform load along the beam span: $W_u = G_u + Q_u = 24.3 \text{ kN/m}$

Applied concentrated load at mid-span: $W_c = G_c + Q_c = 89.3 \text{ kN}$

Maximum deflection limit : $f = L / 300 = 7 / 300$

$$\text{Composite beam deflection of mid-span: } f = \frac{W_u L^4}{384EI} + \frac{W_p L^3}{192EI} = \frac{L}{300}$$

Minimum moment of inertia required, for the composite section, about Y-axis: $I_y = 6670 * 10^4 \text{ mm}^4$

Deflections due to loading applied to the composite beam should be calculated using elastic analysis in accordance with section 5 of EN 1994-1-1 (clause 7.3.1(2) of **[10]**).

Effective width of the slab : $b_{\text{eff}} = 1225 \text{ mm}$

Elastic coefficient of equivalence : $n_{\text{el}} = E_a / E_c \approx 6$

Concrete slab thickness : $h_c = 120 \text{ mm}$

Area of effective section of concrete : $A_c = h_c * b_{\text{eff}} = 147000 \text{ mm}^2$

Second moment of area of the steel section about Y-axis; $I_y = \begin{cases} 11770 * 10^4 \text{ mm}^4 & (\text{IPE330}) \\ 16270 * 10^4 \text{ mm}^4 & (\text{IPE360}) \end{cases}$

Section's area of steel profile: $A_a = \begin{cases} 6260 \text{ mm}^2 & (\text{IPE330}) \\ 7270 \text{ mm}^2 & (\text{IPE360}) \end{cases}$

Section's height of steel profile; $h_a = \begin{cases} 330 \text{ mm} & (\text{IPE330}) \\ 360 \text{ mm} & (\text{IPE360}) \end{cases}$

Position of centre of gravity of the steel profile: $Z_a = \frac{h_a}{2} \begin{cases} 165 \text{ mm} & (\text{IPE330}) \\ 180 \text{ mm} & (\text{IPE360}) \end{cases}$

$$\text{Position of centre of gravity of the concrete slab: } Z_c = h_a + \frac{h_c}{2} = \begin{cases} 390 \text{ mm} & (\text{IPE330}) \\ 420 \text{ mm} & (\text{IPE360}) \end{cases}$$

$$\text{Total height of the composite section: } h_b = h_a + h_c = \begin{cases} 450 \text{ mm} & (\text{IPE330}) \\ 480 \text{ mm} & (\text{IPE360}) \end{cases}$$

Considering the following condition (table 4.57 of [11]):

$$A_a(h_b - Z_a - h_c) = \begin{cases} 1033.10^3 & (\text{IPE330}) \\ 1309.10^3 & (\text{IPE360}) \end{cases} < \frac{A_c \cdot h_c}{2 \cdot n_{el}} = 1588.10^3$$

=> The neutral axis lies within the slab

$$\text{Position of neutral axis of composite section, } Z_b: \quad Z_b = h_b - \frac{n_{el}}{b_{eff}} \cdot A_a \cdot \left[-1 + \sqrt{1 + 2 \cdot \frac{b_{eff} \cdot (h - Z_a)}{n_{el} \cdot A_a}} \right]$$

$$Z_b = \begin{cases} 348.05 \text{ mm} & (\text{IPE330}) \\ 368.51 \text{ mm} & (\text{IPE360}) \end{cases}$$

Second moment of area of the composite section about the Y-axis, I_b :

$$I_b = I_a + A_a \cdot (Z_a - Z_b)^2 + b_{eff} \cdot \frac{(h - Z_b)^3}{3 \cdot n_{el}}$$

$$I_b = \begin{cases} 40500.10^4 \text{ mm}^4 & (\text{IPE330}) \\ 52290.10^4 \text{ mm}^4 & (\text{IPE360}) \end{cases} > 16270.10^4 \text{ mm}^4$$

Minimum area of steel reinforcement

For cross-sections whose resistance moment is determined by (Clauses 6.2.1.2, 6.2.1.3 or 6.2.1.4 of [10]), a minimum area of reinforcement (A_s) within the effective width of the concrete flange should be provided to satisfy the following condition (Clause 5.5.1(5) of [10]):

$$A_s \geq \rho_s \cdot A_c$$

$$\text{with: } \rho_s = \delta \cdot \frac{f_y}{235} \cdot \frac{f_{ctm}}{f_{sk}} \cdot \sqrt{k_c}$$

k_c is a coefficient which takes account of the stress distribution within the section immediately prior to

$$\text{cracking and is given by (Clause 7.4.2(1) of [10]): } k_c = \frac{1}{1 + \frac{h_c}{2Z_0}} + 0.3 \leq 1.0$$

h_c is the thickness of the concrete flange, excluding any haunch or ribs: $h_c = 120 \text{ mm}$

Z_0 is the vertical distance between the centroids of the un-cracked concrete flange and the un-cracked composite section, calculated using the modular ratio ($n_{el} = 6$) for short-term loading: $Z_0 = Z_1 - Z_b$

$$Z_1 = h_a + \frac{h_c}{2}$$

Z_1 is the centroid of the un-cracked concrete flange:

$$Z_1 = \begin{cases} 390 \text{ mm} & (IPE330) \\ 420 \text{ mm} & (IPE360) \end{cases}$$

Z_b is the centroid of the un-cracked composite section:

$$Z_b = \frac{b.t_f \cdot \frac{t_f}{2} + t_w(h_a - 2t_f)\left(\frac{t_w}{2} + t_f\right) + b.t_f\left(h_a - \frac{t_f}{2}\right) + \frac{h_c}{n_{el}} \cdot b_{eff}\left(h_a + \frac{h_c}{2n_{el}}\right)}{b.t_f + t_w(h_a - 2t_f) + b.t_f + \frac{h_c}{n_{el}} \cdot b_{eff}}$$

$$n_{el} = 6.0$$

$$b_{beff} = 1400 \text{ mm} \text{ (Plastic Seismic Design)}$$

$$t_f = \begin{cases} 11.5 \text{ mm} & (IPE 330) \\ 12.7 \text{ mm} & (IPE 360) \end{cases}$$

$$t_w = \begin{cases} 7.5 \text{ mm} & (IPE 330) \\ 8.0 \text{ mm} & (IPE 360) \end{cases}$$

$$h_a = \begin{cases} 330 \text{ mm} & (IPE 330) \\ 360 \text{ mm} & (IPE 360) \end{cases}$$

$$b = \begin{cases} 160 \text{ mm} & (IPE 330) \\ 170 \text{ mm} & (IPE 360) \end{cases}$$

So :

$$Z_b = \begin{cases} 299.045 \text{ mm} & (IPE 330) \\ 319.532 \text{ mm} & (IPE 360) \end{cases}$$

With:

$$Z_0 = Z_1 - Z_b$$

$$Z_0 = \begin{cases} 90.96 \text{ mm} & (IPE330) \\ 100.5 \text{ mm} & (IPE360) \end{cases}$$

So:

$$k_c = \frac{1}{1 + \frac{h_c}{2Z_0}} + 0.3$$

$$k_c = \begin{cases} 0.903 & (IPE330) \\ 0.926 & (IPE360) \end{cases}$$

And finally:

$$A_c = b_{eff} * h_c$$

A_c is the effective area of the concrete flange: $A_c = 1400 * 120$

$$A_c = 168000 \text{ mm}^2$$

f_y is the nominal value of the yield strength of the structural steel in N/mm^2 ; f_{sk} is the characteristic yield strength of the reinforcement;

$$f_y = \begin{cases} 355 \text{ N/mm}^2 & (IPE330) \\ 235 \text{ N/mm}^2 & (IPE360) \end{cases} \quad f_{sk} = \begin{cases} 500 \text{ N/mm}^2 & (IPE330) \\ 450 \text{ N/mm}^2 & (IPE360) \end{cases}$$

f_{ctm} is the mean tensile strength of the concrete, (Table 3.1 or Table 11.3.1 of [13]);

$$f_{ck} = \begin{cases} 30 \text{ N/mm}^2 \Rightarrow f_{ctm} = 2.9 \text{ N/mm}^2 & (IPE330) \\ 25 \text{ N/mm}^2 \Rightarrow f_{ctm} = 2.6 \text{ N/mm}^2 & (IPE360) \end{cases}$$

δ is equal to 1.0 for Class 2 cross-sections, and equal to 1.1 for Class 1 cross-sections at which plastic hinge rotation is required; $\delta = 1.0$ (as we have composite beam cross-sections of class 2)

$$\rho_s = \delta \frac{f_y}{235} \cdot \frac{f_{ctm}}{f_{sk}} \cdot \sqrt{k_c}$$

$$\rho_s = \begin{cases} 8.324 * 10^{-3} = 0.8\% & (IPE330) \\ 5.560 * 10^{-3} = 0.6\% & (IPE360) \end{cases}$$

So:

And finally, the inequality of minimum reinforcement area of the composite section had been satisfied as shown below:

$$A_s \geq \rho_s * A_c$$

$$A_s = 1583 \geq \rho_s * A_c = \begin{cases} 1398 & (IPE330) \\ 934 & (IPE360) \end{cases}$$

Negative Bending Resistance

We calculate the negative bending resistance of the composite section at end support, and in case of seismic design situations, as follows:

Effective width of the slab: $b_{eff} = 1400 \text{ mm}$.

Slab's thickness: $h_c = 120 \text{ mm}$

The longitudinal reinforcement steel consists of 14 bars of 12 mm diameter and is divided into two layers ($A_s = 1583 \text{ mm}^2$).

$$\text{Section's area of steel profile: } A_a = \begin{cases} 6260 \text{ mm}^2 & (IPE330) \\ 7270 \text{ mm}^2 & (IPE360) \end{cases}$$

$$\text{Section's height of steel profile: } h_a = \begin{cases} 330 \text{ mm} & (IPE330) \\ 360 \text{ mm} & (IPE360) \end{cases}$$

$$\text{Position of centre of gravity of the steel profile: } Z_a = \frac{h_a}{2} \begin{cases} 165 \text{ mm} & (IPE330) \\ 180 \text{ mm} & (IPE360) \end{cases}$$

$$\text{Position of centre of gravity of the concrete slab: } Z_c = h_a + \frac{h_c}{2} = \begin{cases} 390 \text{ mm} & (IPE330) \\ 420 \text{ mm} & (IPE360) \end{cases}$$

$$\text{Total height of the composite section: } h_b = h_a + h_c = \begin{cases} 450 \text{ mm} & (IPE330) \\ 480 \text{ mm} & (IPE360) \end{cases}$$

$$\text{Position of centre of gravity of the reinforcing steel: } Z_s = h_b - \frac{h_c}{2} = \begin{cases} 390 \text{ mm} & (IPE330) \\ 420 \text{ mm} & (IPE360) \end{cases}$$

$$\text{The plastic coefficient of equivalence for the reinforcing steel: } n_{pls} = \frac{f_y \cdot \gamma_s}{f_{sk} \cdot \gamma_M}$$

$$n_{pls} = \begin{cases} 0.82 & (IPE330) \\ 0.60 & (IPE360) \end{cases}$$

Considering the following condition (table 4.60 of [11]):

$$A_a - 2bt_f = \begin{cases} 2580 & (IPE330) \\ 2952 & (IPE360) \end{cases} > \frac{A_s}{n_{pls}} = \begin{cases} 1938 & (IPE330) \\ 2635 & (IPE360) \end{cases}$$

=> The neutral axis lies within the web

Position of neutral axis, Z_b :

$$Z_b = \frac{1}{2t_w} \cdot \left(\frac{A_s}{n_{pls}} - A_a \right) + \frac{b \cdot t_f}{t_w} + h_a - t_f$$

$$Z_b = \begin{cases} 275.72 \text{ mm} & (IPE330) \\ 327.50 \text{ mm} & (IPE360) \end{cases}$$

Plastic modulus of the composite beam, W_{plb} :

$$W_{plb} = A_s \cdot \frac{Z_s}{n_{pls}} - A_a \cdot Z_a + 2bt_f \cdot \left(h_a - \frac{t_f}{2} \right) + t_w (h_a - t_f)^2 - t_w \cdot Z_b^2$$

$$W_{plb} = \begin{cases} 1107.10^3 \text{ mm}^3 & (IPE330) \\ 1432.10^3 \text{ mm}^3 & (IPE360) \end{cases}$$

Negative bending resistance of the composite section, M:

$$M^- = W_{plb} * f_y$$

$$M^- = \begin{cases} 393 \text{ kN.m (IPE330)} \\ 337 \text{ kN.m (IPE360)} \end{cases}$$

In the same way, we calculate the negative bending resistance of composite section in persistent and transient design situations.

Effective width of the slab: $b_{eff} = 875$ mm (at end support)

$$M^- = W_{plb} * f_y$$

Negative bending moment of the composite section, M, at end support:

$$M^- = \begin{cases} 342 \text{ kN.m (IPE330)} \\ 317 \text{ kN.m (IPE360)} \end{cases}$$

Positive Bending Resistance

We calculate the positive bending resistance of the composite section at end support, and in case of seismic design situations, as follows:

Effective width of the slab: $b_{eff} = 1050$ mm

Reinforcement in compression in the concrete slab may be neglected (Clause 6.2.1.2(C) of [10]).

$$n_{pl} = \frac{f_y \cdot \gamma_c}{0.85 f_{ck} \cdot \gamma_M}$$

The plastic coefficient of equivalence for the profile steel:

$$n_{pl} = \begin{cases} 20.90 \text{ (IPE330)} \\ 16.60 \text{ (IPE360)} \end{cases}$$

Considering the following conditions (table 4.60 of [11]):

$$A_a - 2bt_f = 2580 < \frac{A_c}{n_{pl}} = 6034 < A_a = 6260 \quad (\text{IPE330})$$

The neutral axis lies within the upper flange of steel section IPE330.

$$A_a = 7270 < \frac{A_c}{n_{pl}} = 7596 \quad (\text{IPE360})$$

The neutral axis lies within the slab of composite section IPE360.

$$\text{Position of neutral axis, } Z_b: \quad Z_b = h_a + \frac{\left(\frac{A_c}{n_{pls}} - A_a \right)}{2b} = 329.3 \text{ mm} \quad (\text{IPE330})$$

$$Z_b = \frac{1}{2b} \cdot \left(\frac{A_c}{n_{pls}} - A_a \right) + h_b - n_{pl} \frac{A_a}{b_{eff}} = 365.2 \text{ mm} \quad (\text{IPE360})$$

Plastic modulus of the composite beam, W_{plb} :

$$W_{plb} = A_c \cdot \frac{Z_c}{n_{pl}} - A_a \cdot Z_a + b(h_a^2 - Z_b^2) = 1668.10^3 \text{ mm}^3 \text{ (IPE330)}$$

$$W_{plb} = A_a \left(h_b - Z_a - \left(\frac{n_{pl} * A_a}{2b_{eff}} \right) \right) = 1764.10^3 \text{ mm}^3 \text{ (IPE330)}$$

Positive bending resistance of the composite section, M:

$$M^+ = W_{plb} * f_y$$

$$M^+ = \begin{cases} 495 \text{ kN.m (IPE330)} \\ 415 \text{ kN.m (IPE360)} \end{cases}$$

In the same way, we calculate the bending resistance of composite section in persistent and transient design situations.

Effective width of the slab: $b_{eff} = 1225 \text{ mm}$ (at mid-span)

$$M^+ = W_{plb} * f_y$$

Positive bending moment of the composite section, M, at mid-span:

$$M^+ = \begin{cases} 515 \text{ kN.m (IPE330)} \\ 428 \text{ kN.m (IPE360)} \end{cases}$$

Maximum Work-Rate of Beams

The design of the structure was made in accordance with the Eurocodes 3, 4 and 8. The maximum work-rate (i.e. ratio of design moment to moment resistance) obtained for section checks of beams are given in the table below:

	Maximum work-rate	
	Static Actions	Seismic Actions
	(EC4)	(EC8)
Case 1 : high seismicity (with steel columns)	0.933	0.826
Case 2 : high seismicity (with composite columns)	0.953	0.840
Case 3 : low seismicity (with steel columns)	0.979	0.764
Case 4 : low seismicity (with composite columns)	1.000	0.779

Resistance to Lateral-Torsional Buckling

To ensure that the precedent check of flexural resistance is valid, it must be verified that beams are not affected by the instability of lateral-torsional buckling before reaching their plastic strength. According to the Annexe B of the ENV 1994-1-1 (clause B.1.2 (4) of **15J**), the elastic critical moment

for lateral-torsional–buckling of a doubly symmetric composite section is given by the following formula:

$$M_{cr} = \frac{k_c C_4}{L} \left[\left(GI_{at} + \frac{k_s L^2}{\pi^2} \right) E_a I_{afz} \right]^{0.5}$$

L is the length between two lateral restraints of the lower flange: L=7 m

G is the shear modulus of steel profile: $G = E / 2(1+\nu)$

ν_a is the Poisson coefficient of steel profile: $\nu_a = 0.3$

E_a is the modulus of elasticity of steel profile: $E_a = 210 \cdot 10^3 \text{ N/mm}^2$

$G = 80769 \text{ N/mm}^2$

I_{at} is the St. Venant torsion constant of the structural steel profile: $I_{at} = \begin{cases} 281500 \text{ mm}^4 & (\text{IPE330}) \\ 373200 \text{ mm}^4 & (\text{IPE360}) \end{cases}$

I_{afz} is the second moment of area of the lower flange about Z-axis:

$$I_{afz} = \frac{b^3 t_f}{12} = \begin{cases} 4.0 \cdot 10^6 \text{ mm}^4 & (\text{IPE330}) \\ 5.2 \cdot 10^6 \text{ mm}^4 & (\text{IPE360}) \end{cases}$$

b is the width of the lower flange of steel profile about the Z-axis: $b = \begin{cases} 160 \text{ mm} & (\text{IPE330}) \\ 170 \text{ mm} & (\text{IPE360}) \end{cases}$

t_f is the thickness of the lower flange of steel profile: $t_f = \begin{cases} 11.5 \text{ mm} & (\text{IPE330}) \\ 12.7 \text{ mm} & (\text{IPE360}) \end{cases}$

k_s is the transversal stiffness per unit length unit of the beam: $k_s = \frac{k_1 k_2}{(k_1 + k_2)}$

k_1 is the flexural stiffness of the continuous slab over the steel profile: $k_1 = \frac{4E_a I_2^*}{a}$

a is the slab's width: a = 6 m

I_2^* is the flexural rigidity of a section of unit width of the slab (with 5 reinforcing steel bars of 8 mm diameter in Y direction): $I_2^* = 9.105 \cdot 10^4 \text{ mm}^4$

$$k_1 = 1.214 \cdot 10^7$$

k_2 is a factor which is equal, for non-encased beam, to: $k_2 = \frac{E_a t_w^3}{4(1-\nu_a^2)h_s}$

t_w is the web's thickness of the steel profile: $t_w = \begin{cases} 7.5 \text{ mm} & (\text{IPE330}) \\ 8.0 \text{ mm} & (\text{IPE360}) \end{cases}$

h_s is the distance between shear centres of steel flanges: $h_s = \begin{cases} 318.5 \text{ mm (IPE330)} \\ 347.3 \text{ mm (IPE360)} \end{cases}$

$$k_2 = \begin{cases} 7.278 \cdot 10^4 \text{ (IPE330)} \\ 8.1 \cdot 10^4 \text{ (IPE360)} \end{cases}$$

$$k_s = \begin{cases} 7.234 \cdot 10^4 \text{ (IPE330)} \\ 8.046 \cdot 10^4 \text{ (IPE360)} \end{cases}$$

C_4 is a factor which depends on the distribution of moment along the length L: $C_4 = \pi^2 \sqrt{\alpha} + \frac{1}{\sqrt{\alpha}}$

α is a coefficient which is equal to: $\alpha = \frac{E_a I_{afz} h_s^2}{\left(G I_{at} + k_s \frac{L^2}{\pi^2} \right) L^2}$

$$\alpha = \begin{cases} 4.268 \cdot 10^{-3} \text{ (IPE330)} \\ 5.978 \cdot 10^{-3} \text{ (IPE360)} \end{cases}$$

$$C_4 = \begin{cases} 15.952 \text{ (IPE330)} \\ 13.697 \text{ (IPE360)} \end{cases}$$

k_c is a coefficient which is equal to: $k_c = \left[\frac{\frac{h_s I_y}{I_{ay}}}{\frac{\frac{h_s^2}{4} + i_x^2}{e} + h_s} \right]$

I_{ay} is the second moment of area of the steel profile about the Y-axis:

$$I_{ay} = \begin{cases} 1177 \cdot 10^5 \text{ mm}^4 \text{ (IPE330)} \\ 1627 \cdot 10^5 \text{ mm}^4 \text{ (IPE360)} \end{cases}$$

I_y is the second moment of area of the composite section about Y-axis:

$$I_y = \begin{cases} 1.577 \cdot 10^8 \text{ mm}^4 \text{ (IPE330)} \\ 2.090 \cdot 10^8 \text{ mm}^4 \text{ (IPE360)} \end{cases}$$

i_x is coefficient equal to: $i_x = \sqrt{\frac{(I_{ay} + I_{az})}{A_a}}$

I_{az} is the second moment of area of the steel profile about Z-axis: $I_{az} = \begin{cases} 788.1 \cdot 10^4 \text{ mm}^4 & (\text{IPE330}) \\ 1043.10^4 \text{ mm}^4 & (\text{IPE360}) \end{cases}$

A_a is the area of the steel section: $A_a = \begin{cases} 6260 \text{ mm}^2 & (\text{IPE330}) \\ 7270 \text{ mm}^2 & (\text{IPE360}) \end{cases}$

$$i_x = \begin{cases} 141.64 & (\text{IPE330}) \\ 154.32 & (\text{IPE360}) \end{cases}$$

e is a coefficient equal to:
$$e = \frac{A I_{ay}}{A_a Z_{ac} (A - A_a)}$$

A is the area of the composite section: $A = \begin{cases} 7164 \text{ mm}^2 & (\text{IPE330}) \\ 8174 \text{ mm}^2 & (\text{IPE360}) \end{cases}$

Z_{ac} is the distance between the centre of gravity of the steel profile and the average level of the slab:

$$Z_{ac} = \begin{cases} 225 \text{ mm} & (\text{IPE330}) \\ 240 \text{ mm} & (\text{IPE360}) \end{cases}$$

$$e = \begin{cases} 662.227 \text{ mm}^4 & (\text{IPE330}) \\ 843.156 \text{ mm}^4 & (\text{IPE360}) \end{cases}$$

$$k_c = \begin{cases} 1.102 & (\text{IPE330}) \\ 1.085 & (\text{IPE360}) \end{cases}$$

The elastic critical moment, for lateral-torsional buckling, of the composite section of the beam is:

$$M_{cr} = \begin{cases} 1374 \text{ kN.m} & (\text{IPE330}) \\ 1416 \text{ kN.m} & (\text{IPE360}) \end{cases}$$

The relative slenderness for lateral-torsional buckling $\bar{\lambda}_{LT}$ is given by (clause 4.6.3(3) of [15]):

$$\bar{\lambda}_{LT} = \left(\frac{M_{pl,Rd}}{M_{cr}} \right)^{0.5} = \begin{cases} \left(\frac{393}{1374} \right)^{0.5} = 0.535 & (\text{IPE330}) \\ \left(\frac{337}{1416} \right)^{0.5} = 0.488 & (\text{IPE360}) \end{cases}$$

The value of the reduction factor could be taken from the EN 1993-1-1 (Clause 6.4.2(1) of [10]).

The reduction factor for lateral-torsional buckling is given by (Clause 6.3.2.3(1) of [12]):

$$\chi_{LT} = \frac{1}{\phi_{LT} + \sqrt{\phi_{LT}^2 - \bar{\lambda}_{LT}^{-2}}} \quad \text{but } \chi_{LT} \leq 1$$

$$\chi_{LT} = \begin{cases} 0.868 & \text{(IPE330)} \\ 0.890 & \text{(IPE360)} \end{cases}$$

ϕ_{LT} is given as follows:

$$\phi_{LT} = 0.5 * \left[1 + \alpha_{LT} * (\bar{\lambda}_{LT} - 0.2) + \bar{\lambda}_{LT}^2 \right]$$

$$\phi_{LT} = \begin{cases} 0.700 & \text{(IPE330)} \\ 0.668 & \text{(IPE360)} \end{cases}$$

The imperfection factor, α_{LT} (Clause 6.3.2.3 and table 6.4 of **[12]**):

For all cases: $\frac{h}{b} = \begin{cases} 2.06 & \text{(IPE330)} \\ 2.12 & \text{(IPE360)} \end{cases} > 2.0 \Rightarrow \alpha = 0.34$ (curve b)

The design buckling resistance moment of a laterally unrestrained continuous composite beam and with a uniform structural steel section should be taken as (clause 4.6.3(1) of **[15]**):

$$M_{b,Rd} = \chi_{LT} M_{PL,Rd} \frac{\gamma_a}{\gamma_{Rd}} \quad \text{with } \gamma_a = 1.0 \text{ et } \gamma_{Rd} = 1.10$$

$$M_{b,Rd} = \begin{cases} 310.3 \text{ kN.m} & \text{(IPE330)} \\ 272.5 \text{ kN.m} & \text{(IPE360)} \end{cases}$$

The risk of lateral-torsional buckling is thus real, since for all cases: $|M_{Ed}|_{\max} > M_{b,Rd}$

Hence, it is necessary to brace the beams laterally. It is easy to verify that a spacing of 1 m between the lateral restraints, i.e. a calculation similar to the above (but $L = 1$ m) would lead to:

$$M_{cr} = \begin{cases} 2821 \text{ kN.m} & \text{(IPE330)} \\ 3981 \text{ kN.m} & \text{(IPE360)} \end{cases}$$

And the relative slenderness for lateral-torsional buckling $\bar{\lambda}_{LT}$ is: $\bar{\lambda}_{LT} = \begin{cases} 0.373 & \text{(IPE330)} \\ 0.291 & \text{(IPE360)} \end{cases}$

Which is less than 0.4 (clause 4.6.3 (5) of **[15]**).

Resistance of Composite Sections in Compression

The plastic resistance to compression $N_{pl,Rd}$ of the composite cross-section should be calculated by adding the plastic resistances of its components:

$$N_{Pl,Rd} = A_a * f_y + \frac{f_{sk} * A_s}{\gamma_s} + 0.85 * \frac{f_{ck} * A_c}{\gamma_c}$$

$$N_{Pl,Rd} = \begin{cases} 5767 \text{ kN} & \text{(IPE330)} \\ 4708 \text{ kN} & \text{(IPE360)} \end{cases}$$

For plastic hinges in the beams it should be verified that the full plastic moment of resistance and rotation capacity are not decreased by compression. To this end, for sections belonging to cross sectional classes 1 and 2, the following inequalities should be verified at the location where the formation of hinges is expected (clause 6.6.2(2) and clause 7.7.3(3) of [8]):

$$\frac{N_{Ed}}{N_{pl,Rd}} \leq 0.15$$

In case of high seismic zones (cases 1 and 2), the check of compression resistance has been done for the beams that are subjected to the maximum axial forces in seismic design situations, while in case of low seismic zones (cases 3 and 4), the check has been done for beams that are subjected to the maximum actions in persistent and transient design situations, where the maximum values are as shown.

$$|N_{Ed}|_{\max} = \begin{cases} 149 \text{ kN} < 0.15 N_{pl,Rd} = 865 \text{ kN} & \text{(Case1)} \\ 142 \text{ kN} < 0.15 N_{pl,Rd} = 865 \text{ kN} & \text{(Case2)} \\ 127 \text{ kN} < 0.15 N_{pl,Rd} = 706 \text{ kN} & \text{(Case3)} \\ 121 \text{ kN} < 0.15 N_{pl,Rd} = 706 \text{ kN} & \text{(Case4)} \end{cases}$$

Shear Resistance

The resistance to vertical shear $V_{pl,Rd}$ should be taken as the resistance of the structural steel section $V_{pl,a,Rd}$ unless the value for a contribution from the reinforced concrete part of the beam has been established (clause 6.2.2.2(1) of [10]). The design plastic shear resistance $V_{pl,a,Rd}$ of the structural steel section should be determined in accordance with the EN 1993-1-1 (clause 6.2.6 of [12]).

Noting that $\frac{h_w}{t_w} = \begin{cases} 307.0/7.5 & \text{(IPE330)} \\ 334.6/8.0 & \text{(IPE330)} \end{cases} = \begin{cases} 41 < 72\varepsilon = 58.58 & \text{(IPE330)} \\ 42 < 72\varepsilon = 72.00 & \text{(IPE360)} \end{cases}$, and according to (clause 6.2.6(1),(2) and (6) of [12]):

$$V_{pl,a,Rd} = \frac{A_v * f_y}{\sqrt{3}} = \begin{cases} 631 \text{ kN} & \text{(IPE330)} \\ 477 \text{ kN} & \text{(IPE360)} \end{cases}$$

When the shear force is less than half the plastic shear resistance, the effect on the moment resistance may be neglected (clause 6.2.8(2) of [12])

For all cases, the check of shear resistance has been done for the beams that are subjected to the maximum vertical shear forces in persistent and transient design situations, where the maximum values are as shown;

$$|V_{Ed}|_{\max} = \begin{cases} 234 \text{ kN} < 0.5V_{pl,a,Rd} = 315.5 \text{ kN} & \text{(Case1)} \\ 237 \text{ kN} < 0.5V_{pl,a,Rd} = 315.5 \text{ kN} & \text{(Case2)} \\ 231 \text{ kN} < 0.5V_{pl,a,Rd} = 238.5 \text{ kN} & \text{(Case3)} \\ 234 \text{ kN} < 0.5V_{pl,a,Rd} = 238.5 \text{ kN} & \text{(Case4)} \end{cases}$$

The shear force has thus no effect on the reduction in combination of moment and axial force (Clause 6.2.10(2) of [12]).

5.17.6 SECTION AND STABILITY CHECKS OF STEEL COLUMNS

Let the composite column, partially encased in concrete, as defined in the following figure, whose steel profile is HEA360 for case1 and HEA450 for case 3. Material properties for the two cases are given as follows:

high seismicity Case1 : Profiles S355, Steel reinforcement S500, Concrete C30/37

low seismicity Case3 : Profiles S235, Steel reinforcement S450, Concrete C25/35

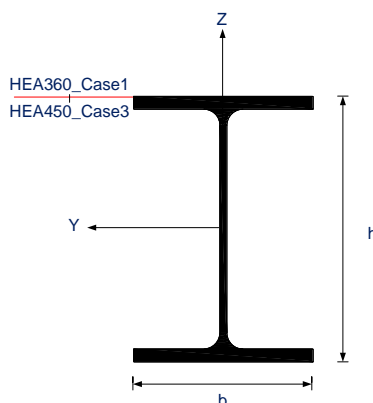

Fig. 5.17.15 Composite column partially encased in concrete

Resistance of Steel Columns in Combined Compression and Uniaxial Bending under Seismic Combination

The columns shall be verified in compression considering the most unfavourable combination of the axial force and bending moments. In the checks (clause 6.6.3(1) of [8]), N_{Ed} , M_{Ed} , V_{Ed} should be computed as:

$$N_{Ed}^* = N_{Ed,G} + 1,1\gamma_{ov}\Omega N_{Ed,E}$$

$$M_{Ed}^* = M_{Ed,G} + 1,1\gamma_{ov}\Omega M_{Ed,E}$$

$$V_{Ed}^* = V_{Ed,G} + 1,1\gamma_{ov}\Omega V_{Ed,E}$$

Where the indices G and E correspond to gravity and seismic loads respectively and where the section overstrength factor Ω is the minimum value, of all beams in which dissipative zones are located, given by the following expression:

$$\Omega = \min \left\{ \Omega_i = \frac{M_{pl,Rd,i}}{|M_{Ed}|_{\max,i}} \right\}$$

$$\Omega = \frac{393}{324.20} = 1.212 \text{ (Case1)}$$

$$\Omega = \frac{337}{257.00} = 1.311 \text{ (Case3)}$$

Where the index "i" covers all beams, M_{Ed} is the design value of the bending moment in beam in the seismic design situation and $M_{Pl,Rd}$ is the corresponding plastic moment, and where the material overstrength factor γ_{ov} is equal to 1.25 (clause 6.2(4) of [8]).

Where there is a axial force, we have to take into account its effects on the plastic moment resistance. For cross-sections of classes 1 and 2, the following expression must be satisfied (clause 6.2.9.1(1) of

$$[12]: M_{Ed} \leq M_{N,Rd} \text{ but } M_{N,Rd} \leq M_{pl,Rd}$$

Where $M_{N,Rd}$, the plastic moment resistance reduced by the normal force N_{Ed} , is given by the following expression, (clause 6.2.9.1(5) of [12]):

$$M_{N y ,Rd} = M_{pl,Rd} \frac{1-n}{1-0.5a} = W_{pl,y} * f_y \frac{1-n}{1-0.5a}$$

$$M_{N y ,Rd} = \begin{cases} 741.24 \frac{1-n}{1-0.5a} & \text{(Case1)} \\ 755.76 \frac{1-n}{1-0.5a} & \text{(Case3)} \end{cases}$$

$$\text{Where : } a = \frac{A - 2bt_f}{A} = \begin{cases} 0.265 & \text{(Case1)} \\ 0.292 & \text{(Case3)} \end{cases}$$

$$n = \frac{N_{Ed}^*}{N_{pl,Rd}} = \frac{N_{Ed}^*}{A * f_y} = \begin{cases} \frac{N_{Ed}^*}{5069.0} & \text{(Case1)} \\ \frac{N_{Ed}^*}{4183.0} & \text{(Case3)} \end{cases}$$

The resistance check in combined compression and uniaxial bending has been done for the columns, located at the base, which are subjected to the maximum axial forces and moments in seismic design situation. The table below provides the values of forces and moments at upper and lower extremities of columns. For all cases, the condition $M_{Ed} \leq M_{N,Rd}$ is largely satisfied.

Case 1: high seismicity – steel columns

		$N_{Ed,G}$	$M_{Ed,G}$	$N_{Ed,E}$	$M_{Ed,E}$	N_{Ed}^*	M_{Ed}^*	$M_{N,y,Rd}$
	End	kN	kNm	kN	kNm	kN	kNm	kNm
column 1	lower	-814	-41	119	140	-616	192	751
	upper	-810	79	119	-39	-612	14	751
column 2	lower	-1652	1	-9	158	-1666	264	574
	upper	-1648	-3	-9	-76	-1663	-130	574
column 3	lower	-1652	-1	8	158	-1638	262	578
	upper	-1648	3	8	-76	-1634	-124	579
column 4	lower	-814	41	-118	138	-1011	272	684
	upper	-810	-79	-118	-39	-1007	-143	685

Case 3: low seismicity – steel columns

		$N_{Ed,G}$	$M_{Ed,G}$	$N_{Ed,E}$	$M_{Ed,E}$	N_{Ed}^*	M_{Ed}^*	$M_{N,y,Rd}$
End		kN	kNm	kN	kNm	kN	kNm	kNm
column 1	lower	-829	-45	56	77	-728	93	731
	upper	-824	-85	56	-12	-723	64	732
column 2	lower	-1650	-1	-3	85	-1655	153	535
	upper	-1645	-1	-3	-29	-1650	-53	536
column 3	lower	-1650	1	2	85	-1646	154	537
	upper	-1645	1	2	-29	-1641	-52	538
column 4	lower	-829	45	-56	76	-930	181	688
	upper	-824	-85	-56	-11	-925	-105	689
column 20	upper	-163	-185	-5	-18	172	217	849

Note: In case 3 (zone of low seismicity), we noted that column number 20 is subjected to the maximum bending moment in seismic design situation as well as in static design situation, which shows that seismic actions has not an important effect on the building with respect to the permanent and transient actions.

Resistance of Steel Columns in Combined Compression and Uniaxial under critical Fundamental Combination

The resistance check in combined compression and uniaxial bending has been done for the columns number 2 and number 20 which are subjected to maximum axial forces and moments respectively in static design situation. The tables shown below provide the values of normal forces and moments where the condition $M_{Ed} \leq M_{N,Rd}$ is largely satisfied

Case 1: high seismicity – composite columns

		N_{Ed}	M_{Ed}	$M_{N,y,Rd}$
End		kNm	kNm	kNm
Col.2	lower	1979	88	521
Col.20	upper	212	238	819

Case 3: low seismicity – composite columns

		N_{Ed}	M_{Ed}	$M_{N,y,Rd}$
End		kNm	kNm	kNm
Col.2	lower	1975	94	467
Col.20	upper	216	258	839

Shear Resistance of Steel Columns

The design plastic shear resistance $V_{pl,a,Rd}$ of the structural steel section should be determined in accordance with the EN 1993-1-1 (clause 6.2.6 of [12]).

$$\text{Noting that } \frac{h_w}{t_w} = \begin{cases} 31.50 < 72\varepsilon = 58.58 \text{ (Case1)} \\ 34.61 < 72\varepsilon = 72.00 \text{ (Case3)} \end{cases}$$

Thus sections are classified into class 1 where there is no local buckling, and according to (clause 6.2.6(1),(2) and (6) of [12]) we have:

$$V_{pl,a,Rd} = \frac{A_v * f_y}{\sqrt{3}} = \begin{cases} 1003.48 \text{ kN (Case1)} \\ 892.490 \text{ kN (Case3)} \end{cases}$$

The check of shear resistance has been done for the columns, number 8 (for case 1_seismic combination) and number 17 (for case 3_static combination), which are subjected to the maximum shear forces in seismic and static design situations respectively, where the maximum values are as shown:

(For case1_Sismic design situation)

$$\begin{aligned} |V_{Ed,G}|_{\max} &= 57.54 \text{ kN} \\ |V_{Ed,E}|_{\max} &= \frac{1}{1-\theta} * 39.96 = \frac{1}{1-0.048} * 39.96 \\ &= 1.05 * 39.96 = 41.80 \text{ kN} \\ |V_{Ed}^*|_{\max} &= |V_{Ed,G} + 1,1\gamma_{ov}\Omega V_{Ed,E}|_{\max} \\ |V_{Ed}^*|_{\max} &= 127.47 \text{ kN} \end{aligned}$$

(For case3_Static design situation)

$$|V_{Ed}|_{\max} = 126.64 \text{ kN}$$

When the shear force is less than half the plastic shear resistance, the effect on the moment resistance may be neglected (clause 6.2.8(2) of [12]) :

$$V_{Ed,\max} = \begin{cases} 127.47 \text{ kN} < 0.5V_{pl,a,Rd} = 501.74 \text{ kN (Case2)} \\ 126.64 \text{ kN} < 0.5V_{pl,a,Rd} = 446.25 \text{ kN (Case4)} \end{cases}$$

The shear force has thus no effect on the reduction in combination of moment and axial force (Clause 6.2.10(2) of [12]).

Reduction Factors for Flexural Buckling

The reduction factor for flexural buckling χ_z is calculated as follows (Clause 6.3.1.3 of [12]);

Buckling length, L_{cr} : $L_{cr} = 3.5$ m (= storey height)

$$\text{Radius of gyration about the Z-axis, } i_z: i_z = \begin{cases} 74.3 \text{ mm (Case1)} \\ 72.9 \text{ mm (Case3)} \end{cases}$$

$$\text{Slenderness ratio of the column } \lambda_z: \lambda_z = \frac{L_{cr}}{i_z} = \begin{cases} 47.12 \text{ mm (Case1)} \\ 48.01 \text{ mm (Case3)} \end{cases}$$

$$\text{Euler's slenderness, } \lambda_E: \lambda_E = \pi * \sqrt{\frac{E_a}{f_y}} = \begin{cases} 74.57 \text{ (Case1)} \\ 91.65 \text{ (Case3)} \end{cases}$$

$$\text{Relative slenderness } \bar{\lambda}_z \text{ is given by: } \bar{\lambda}_z = \frac{\lambda_z}{\lambda_E} = \begin{cases} 0.632 \text{ (Case1)} \\ 0.524 \text{ (Case3)} \end{cases}$$

The reduction factor for the buckling mode about Z-axis is given by (Clause 6.3.1.2 of [12]):

$$\chi_z = \frac{1}{\phi_z + \sqrt{\phi_z^2 - \bar{\lambda}_z^2}} \text{ but } \chi_z \leq 1$$

$$\chi_z = \begin{cases} 0.766 \text{ (Case1)} \\ 0.873 \text{ (Case3)} \end{cases}$$

$$\phi_z = 0.5 * \left[1 + \alpha * (\bar{\lambda}_z - 0.2) + \bar{\lambda}_z^2 \right]$$

Where ϕ_z is given as follows:

$$\phi_z = \begin{cases} 0.805 \text{ (Case1)} \\ 0.692 \text{ (Case3)} \end{cases}$$

And where, for buckling about Z-axis, the imperfection factor is α :

For case 1: $\frac{h}{b} = 1.17 < 1.2$ and $t_f = 17.5 \text{ mm} < 100 \text{ mm} \Rightarrow \alpha = 0.49$ (courbe c)

For case 3: $\frac{h}{b} = 1.47 > 1.2$ and $t_f = 21 \text{ mm} < 40 \text{ mm} \Rightarrow \alpha = 0.34$ (courbe b)

The reduction factor for flexural buckling χ_y is calculated as follows (Clause 6.3.1.3 of [12]):

Buckling length, L_{cr} : $L_{cr} = 3.5$ m (= storey height)

$$\text{The radius of gyration about the Z-axis, } i_y: i_y = \begin{cases} 152.5 \text{ mm (Case1)} \\ 189.2 \text{ mm (Case3)} \end{cases}$$

$$\text{The slenderness ratio of the column } \lambda_y: \lambda_y = \frac{L_{cr}}{i_y} = \begin{cases} 23.00 \text{ mm (Case1)} \\ 18.50 \text{ mm (Case3)} \end{cases}$$

The Euler's slenderness, λ_E : $\lambda_E = \pi * \sqrt{\frac{E_a}{f_y}} = \begin{cases} 74.57 \text{ (Case1)} \\ 91.65 \text{ (Case3)} \end{cases}$

The relative slenderness $\bar{\lambda}_z$ is given by: $\bar{\lambda}_y = \frac{\lambda_y}{\lambda_E} = \begin{cases} 0.308 \text{ (Case1)} \\ 0.202 \text{ (Case3)} \end{cases}$

The reduction factor for the buckling mode about Y-axis is given by (Clause 6.3.1.2 of [12]):

$$\chi_y = \frac{1}{\phi_y + \sqrt{\phi_y^2 - \bar{\lambda}_y^2}} \text{ but } \chi_y \leq 1$$

$$\chi_y = \begin{cases} 0.961 \text{ (Case1)} \\ 1.000 \text{ (Case3)} \end{cases}$$

$$\phi_y = 0.5 * \left[1 + \alpha * (\bar{\lambda}_y - 0.2) + \bar{\lambda}_y^2 \right]$$

$$\phi_y = \begin{cases} 0.566 \text{ (Case1)} \\ 0.521 \text{ (Case3)} \end{cases}$$

Where ϕ_z is given as follows:

And where, for buckling about Y-axis, the imperfection factor, α is:

For case 1: $\frac{h}{b} = 1.17 < 1.2$ and $t_f = 17.5 \text{ mm} < 100 \text{ mm} \Rightarrow \alpha = 0.34$ (courbe b)

For case 3: $\frac{h}{b} = 1.47 > 1.2$ and $t_f = 21 \text{ mm} < 40 \text{ mm} \Rightarrow \alpha = 0.21$ (courbe a)

The following table provides the values of slenderness and reduction factors:

	$\bar{\lambda}_y$	χ_y	$\bar{\lambda}_z$	χ_z
Case 1	0.308	0.961	0.632	0.766
Case 3	0.202	1.000	0.524	0.873

For the elements subjected to axial compression, it is appropriate that the value of axial force meets the following condition (Clause 6.3.1.1(3) of [12]): $N_{Ed} \leq \chi_z N_{Pl,Rd}$

This check, which has been done for the column number 2 which is subjected to the maximum axial force in persistent and transient design situation, is largely satisfied.

$$N_{Ed} = \begin{cases} 1978.6 \text{ kN} < \chi_z N_{Pl,Rd} = 3882.85 \text{ kN (Case1)} \\ 1975.3 \text{ kN} < \chi_z N_{Pl,Rd} = 3651.76 \text{ kN (Case3)} \end{cases}$$

Interaction Factors

The interaction factors for steel columns kyy and kzz are calculated as follows.

Choosing to use Annex B of the EN 1993-1-1 [12], the table B-1 of this Annex proposes:

$$k_{yy} = C_{my} \left[1 + (\bar{\lambda}_y - 0,2) \frac{|N_{Ed}^*|}{\chi_y N_{plRd}} \right]$$

The interaction factor, k_{zy} : $k_{zy} = 0,6 k_{yy}$

The equivalent uniform moment factor, C_{my} : $C_{my} = 0.6 + 0.4\psi \geq 0.4$

ψ is the relationship between algebraic values of the two end moments, where $-1 \leq \psi \leq 1$, (Annex B and table B.3 of [12]). The following tables bring together the values obtained of ψ , C_{my} and the associated factors of interaction.

Case 1: high seismicity – steel columns

		M_{Ed}^*	ψ	C_{my}
Extremity		kNm		
column 1	lower	192	0.0729	0.6292
	upper	14		
column 2	lower	264	-0.4924	0.4030
	upper	-130		
column 3	lower	262	-0.4733	0.4107
	upper	-124		
column 4	lower	272	-0.5257	0.4000
	upper	-143		

	$ N_{Ed}^* _{max}$	$\bar{\lambda}_y$	χ_y	N_{plRd}	k_{yy}	K_{zy}
	kN			kN		
Column 1	616	0.308	0.961	5069	0.638	0.383
Column 2	1666	0.308	0.961	5069	0.418	0.251
Column 3	1638	0.308	0.961	5069	0.426	0.255
Column 4	1011	0.308	0.961	5069	0.409	0.245

Case 3: low seismicity – steel columns

		M_{Ed}^*	ψ	C_{my}
Extremity		kNm		
column 1	lower	93	0.6882	0.8753
	upper	64		
column	lower	153	-0.3464	0.4614

2	upper	-53		
column	lower	154		
3	upper	-52	-0.3377	0.4649
column	lower	181		
4	upper	-105	-0.5801	0.4000

	$ N_{Ed}^* _{\max}$	$\bar{\lambda}_y$	χ_y	N_{plRd}	k_{yy}	K_{zy}
	kN			kN		
Column 1	728	0.202	1.0	4183	0.876	0.525
Column 2	1655	0.202	1.0	4183	0.462	0.277
Column 3	1646	0.202	1.0	4183	0.465	0.279
Column 4	930	0.202	1.0	4183	0.400	0.240

Reduction Factor for Lateral Torsional-Buckling

In accordance with the Annex F of the ENV 1993-1-1 (clause F.1.3 (1) of **[16]**), the elastic critical moment for lateral-torsional –buckling of a doubly symmetric section is given by the following formula:

$$M_{cr} = C_1 \frac{\pi^2 EI_z}{(kL)^2} \left\{ \left[\left(\frac{k}{k_w} \right)^2 \frac{I_w}{I_z} + \frac{(kL)^2 GI_t}{\pi^2 EI_z} + (C_2 z_G)^2 \right]^{0.5} - (C_2 z_G) \right\}$$

Where: $Z_G = Z_a - Z_s$ Z_a = coordinate of the point of application of the load
 Z_s = coordinate of the shear centre

In the case of loading by end moments ($C_2 = 0$) or by applying transverse loads at the shear centre ($Z_G = 0$), the previous formula becomes (clause F.1.3 (2) of **[16]**):

$$M_{cr} = C_1 \frac{\pi^2 EI_z}{(kL)^2} \left[\left(\frac{k}{k_w} \right)^2 \frac{I_w}{I_z} + \frac{(kL)^2 GI_t}{\pi^2 EI_z} \right]^{0.5}$$

Where: L is the length of column, L = 3.5 m; ν is the Poisson coefficient of steel profile, $\nu = 0.3$; E is the modulus of elasticity of steel profile, $E = 210 \cdot 10^3 \text{ N/mm}^2$; G is the shear modulus of steel profile, $G = E/2(1+\nu) = 80769 \text{ N/mm}^2$; I_z is the second moment of area of the steel profile about Z-axis; I_t is the St. Venant torsion constant of the structural steel section; I_w is the warping moment of the steel section; C_1 is a factor which depends on the load and support conditions; k and k_w are the effective length factors.

According to the rigidity of joints between beams and columns, we can consider that the beam is fixed at both ends preventing the lateral translation and the torsional rotation, the factors of the effective length are given (clause F.1.2(2) of **[16]**) as: $k = k_w = 0.5$

According to the indications of table F.1.1 of **[16]**, we can adopt by interpolation, and for $k = 0.5$, the values of coefficient C_1 as shown in the table below.

The relative slenderness for lateral- torsional buckling $\bar{\lambda}_{LT}$ is given by (clause 5.5.2(5) of [16]);

$$\bar{\lambda}_{LT} = \left(\frac{M_{Pl,Rd}}{M_{cr}} \right)^{0.5}$$

The reduction factor for lateral-torsional buckling is given by (Clause 6.3.2.3(1) of [12]).

$$\chi_{LT} = \frac{1}{\phi_{LT} + \sqrt{\phi_{LT}^2 - \bar{\lambda}_{LT}^2}} \text{ but } \chi_{LT} \leq 1$$

Where ϕ_{LT} is given as follows; $\phi_{LT} = 0.5 * \left[1 + \alpha_{LT} * (\bar{\lambda}_{LT} - 0.2) + \bar{\lambda}_{LT}^2 \right]$

And where the imperfection factor, α_{LT} (Clause 6.3.2.3 and table 6.4 of [12]) is:

For case 1: $\frac{h}{b} = 1.17 < 2.0 \Rightarrow \alpha = 0.21$ (courbe a)

For case 3: $\frac{h}{b} = 1.47 < 2.0 \Rightarrow \alpha = 0.21$ (courbe a)

The following tables bring together the values of elastic critical moment, the relative slenderness and the associated reduction factors. As the reduction factor $\bar{\lambda}_{LT} \leq 0.4$, it is not necessary to take the lateral-torsional buckling into account (clause 5.5.2 (7) of [16]).

Case 1: high seismicity – steel columns

column	ψ	C_1	M_{cr} (kN.m)	$\bar{\lambda}_{LT}$	ϕ_{LT}	χ_{LT}
1	0.0729	2.044	18850	0.198	0.519	1.0
2	-0.4924	3.078	28390	0.162	0.509	1.0
3	-0.4733	3.041	28050	0.163	0.509	1.0
4	-0.5257	3.119	28770	0.161	0.509	1.0

Case 3: low seismicity – steel columns

Column	ψ	C_1	M_{cr} (kN.m)	$\bar{\lambda}_{LT}$	ϕ_{LT}	χ_{LT}
1	0.6882	1.357	18820	0.200	0.520	1.0
2	-0.3464	2.796	38790	0.140	0.503	1.0
3	-0.3377	2.779	38550	0.140	0.504	1.0
4	-0.5801	3.175	44040	0.131	0.501	1.0

Stability Checks

Columns not susceptible to torsional deformations, and which are loaded by combined and axial compression, should satisfy the following expressions (clause 6.3.3(4) of [12]):

$$\frac{|N_{Ed}^*|}{\chi_y N_{plRd}} + k_{yy} \frac{|M_{y,Ed}^*|_{\max}}{\chi_{LT} M_{plRd}} \leq 1$$

$$\frac{|N_{Ed}^*|}{\chi_z N_{plRd}} + k_{zy} \frac{|M_{y,Ed}^*|_{\max}}{\chi_{LT} M_{plRd}} \leq 1$$

χ_y and χ_z are the reduction factors due to flexural buckling.

χ_{LT} is the reduction factor due to lateral torsional buckling.

k_{yy} and k_{zy} are the reduction factors.

$|M_{y,Ed}^*|_{\max}$ is the maximum end moment of column in absolute value

The following tables bring together the design values of the compression forces and the end moments about the y-y axis.

Case 1: high seismicity – steel columns

Column	$ N_{ED}^* $ kN	$ M_{ED}^* _{\max}$ kN.m	χ_y	χ_z	k_{yy}	k_{zy}
1	616	192	0.961	0.766	0.638	0.383
2	1666	264	0.961	0.766	0.418	0.251
3	1638	262	0.961	0.766	0.426	0.255
4	1011	272	0.961	0.766	0.409	0.245

Case 3: low seismicity – steel columns

Column	$ N_{ED}^* $ kN	$ M_{ED}^* _{\max}$ kN.m	χ_y	χ_z	k_{yy}	k_{zy}
1	728	93	1.0	0.873	0.876	0.525
2	1655	153	1.0	0.873	0.462	0.277
3	1646	154	1.0	0.873	0.465	0.279
4	930	181	1.0	0.873	0.400	0.240

Consequently, lateral torsional buckling has no effect on the ultimate load of the column. Considering the columns, from 1 to 4, located at the base of the MR frame, the values (given in the following table) are clearly less than 1.

Case 1: high seismicity – steel columns

Column	$\frac{ N_{Ed}^* }{\chi_y A f_y} + k_{yy} \frac{ M_{y,Ed}^* _{\max}}{\chi_{LT} W_{y,pl} f_y}$	$\frac{ N_{Ed}^* }{\chi_z A f_y} + k_{zy} \frac{ M_{y,Ed}^* _{\max}}{\chi_{LT} W_{y,pl} f_y}$
1	0.292	0.258
2	0.491	0.518
3	0.487	0.512
4	0.358	0.350

Case 3: low seismicity – steel columns

Column	$\frac{ N_{Ed}^* }{\chi_y A f_y} + k_{yy} \frac{ M_{y,Ed}^* _{\max}}{\chi_{LT} W_{y,pl} f_y}$	$\frac{ N_{Ed}^* }{\chi_z A f_y} + k_{zy} \frac{ M_{y,Ed}^* _{\max}}{\chi_{LT} W_{y,pl} f_y}$
1	0.282	0.264
2	0.489	0.509
3	0.488	0.508
4	0.318	0.312

Consequently, the stability of columns subject to axial compression and bending in the plane of buckling is largely satisfied.

5.17.7 SECTION AND STABILITY CHECKS OF COMPOSITE COLUMNS

Let the composite column, partially encased in concrete, as defined in the following figure, whose steel profile is HEA320 for case2 and HEA400 for case 4. Material properties for the two cases are given as follows:

- High seismicity Case 2 : Profiles S355, Steel reinforcement S500, Concrete C30/37
- Low seismicity Case 4 : Profiles S235, Steel reinforcement S450, Concrete C25/35

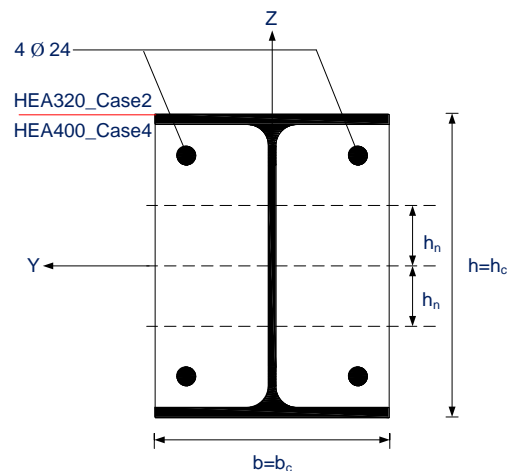

Fig. 5.17.16 Composite column partially encased in concrete

General Checks

Spacing of reinforcing steel bars

We have to choose a free distance between reinforcing steel bars greater than or equal to the greatest of the following values: k_1 times the diameter of the bar, $(d_g + k_2)$ mm or 20 mm, where d_g is the size of the greatest aggregate and where the recommended values of k_1 and k_2 are 1 and 5 respectively (clause 8.2(2) of [13]). It is allowed to choose a distance, between longitudinal bars and the steel profiles, less than the values indicated in [13], and even equal to zero (clause 4.8.2.5(6) of [15]).

Local buckling resistance

The effects of local buckling may be neglected (Clause 6.7.1(9) of [10]) or (clause 4.8.2.4 of [15]) for a steel section partially encased, provided that maximum values of (Table 6.3 [10]) are not exceeded.

$$\frac{b}{t_f} = 19.36 < 44\varepsilon = 35.80 \quad (\text{Case2})$$

$$\frac{b}{t_f} = 15.80 < 44\varepsilon = 44 \quad (\text{Case4})$$

We thus ignore such effects.

Longitudinal reinforcing steel bars

The longitudinal reinforcement area (A_s) in concrete-encased columns which is allowed for in the resistance of the cross-section should be not less than 0.3% (clause 4.8.2.5(3) of [15]) or greater than 4% (clause 4.8.3.1 (3, e) of [15]) of the cross-section of the concrete (A_c).

$$0.3\%A_c < A_s < 4\%A_c$$

$$0.3 < \frac{100A_s}{A_c} < 4$$

$$\frac{100A_s}{A_c} = \begin{cases} 2.300 & (\text{Case2}) \\ 1.822 & (\text{Case4}) \end{cases}$$

Resistance of Composite Columns in Uniaxial Bending

The value of plastic modulus of the steel reinforcement is obtained by (clause C.6.1 (2) of [15]):

$$W_{ps} = \sum_{i=1}^n |A_{si} * e_i|$$

$$W_{ps} = \begin{cases} 1.945 \cdot 10^5 \text{ mm}^3 & (\text{Case2}) \\ 2.606 \cdot 10^5 \text{ mm}^3 & (\text{Case4}) \end{cases}$$

Where e_i is the distance between the steel bars of area A_{si} and the appropriate central axis (Y-axis).

Value of plastic modulus of the profile steel and concrete respectively (clause C.6.2 (1) of [15]) are:

$$W_{pa} = (h_a - 2t_f)^2 \cdot \frac{t_w}{4} + b t_f \cdot (h_a - t_f)$$

$$W_{pa} = \begin{cases} 1.545 \cdot 10^6 \text{ mm}^3 & (\text{Case2}) \\ 2.471 \cdot 10^6 \text{ mm}^3 & (\text{Case4}) \end{cases}$$

and

$$W_{pc} = \frac{b \cdot h_a^2}{4} - W_{pa} - W_{ps}$$

$$W_{pc} = \begin{cases} 5.468 \cdot 10^6 \text{ mm}^3 & (\text{Case2}) \\ 8.676 \cdot 10^6 \text{ mm}^3 & (\text{Case4}) \end{cases}$$

Half-height of the region of $2h_n$ height (clause C.6.2 (2) of [15]).

$$h_n = \left(\frac{N_{pm,Rd} - A_{sn} \left(\frac{2f_{sk}}{1.15} - 0.85 \frac{f_{ck}}{1.5} \right)}{0.85 \frac{2bf_{ck}}{1.5} + 2t_w \left(2f_y - 0.85 \frac{f_{ck}}{1.5} \right)} \right)$$

$$h_n = \begin{cases} 59.04 \text{ mm (Case2)} \\ 74.10 \text{ mm (Case4)} \end{cases}$$

Where $N_{pm,Rd}$ is the applied normal force on the column when the plastic moment resistance of the section is reached (clause C.6.1(1) of **[15]**).

$$N_{pm,Rd} = \frac{0.85A_c f_{ck}}{1.5}$$

$$N_{pm,Rd} = \begin{cases} 1.339 \cdot 10^6 \text{ N (Case2)} \\ 1.407 \cdot 10^6 \text{ N (Case4)} \end{cases}$$

And where A_{sn} is the sum of areas of steel reinforcing steel bars located in the region of $2h_n$ height.

$$A_{sn} = \begin{cases} 0 \text{ mm}^2 \text{ (Case2)} \\ 0 \text{ mm}^2 \text{ (Case4)} \end{cases}$$

Plastic modulus of the steel reinforcement located in the region of $2h_n$ height (clause C.6.2(3) of **[15]**):

$$W_{psn} = \sum_{i=1}^n |A_{sni} * e_i|$$

$$W_{psn} = \begin{cases} 0 \text{ mm}^3 \text{ (Case2)} \\ 0 \text{ mm}^3 \text{ (Case4)} \end{cases}$$

Plastic modulus of the steel profile located in the region of $2h_n$ height (clause C.6.2(2) of **[15]**):

$$W_{pan} = t_w h_n^2$$

$$W_{pan} = \begin{cases} 3.138 \cdot 10^4 \text{ mm}^3 \text{ (Case2)} \\ 6.313 \cdot 10^4 \text{ mm}^3 \text{ (Case4)} \end{cases}$$

Plastic modulus of the concrete located in the region of $2h_n$ height (clause C.6.2(2) of **[15]**):

$$W_{pcn} = bh_n^2 - W_{pan} - W_{psn}$$

$$W_{pcn} = \begin{cases} 1.014 \cdot 10^6 \text{ mm}^3 \text{ (Case2)} \\ 1.584 \cdot 10^6 \text{ mm}^3 \text{ (Case4)} \end{cases}$$

Maximum flexural resistance of the composite section when the axial force $0.5 N_{pm,Rd}$ is applied on the column (clause C.4(2) of **[15]**):

$$M_{\max,Rd} = W_{pa} f_y + \frac{W_{ps} f_{sk}}{1.15} + 0.85 \frac{W_{pc}}{2} * \frac{f_{ck}}{1.5}$$

$$M_{\max,Rd} = \begin{cases} 679.380 \text{ kN.m (Case2)} \\ 744.087 \text{ kN.m (Case4)} \end{cases}$$

Plastic moment resistance of the section when an axial force of 0 kN or 0.5 Npm,Rd kN is applied on the column (clause C.4(3) of **[15]**):

$$M_{pl,Rd} = M_{\max,Rd} - M_{n,Rd}$$

$$M_{pl,Rd} = 536.94 \text{ kN.m}$$

$$M_{pl,Rd} = \begin{cases} 659.62 \text{ kN.m (Case2)} \\ 718.03 \text{ kN.m (Case4)} \end{cases}$$

$M_{n,Rd}$ is the flexural resistance of the region of $2h_n$ height

$$M_{n,Rd} = W_{pna} f_y + \frac{W_{psn} f_{sk}}{1.15} + 0.85 \frac{W_{pcn}}{2} * \frac{f_{ck}}{1.5}$$

$$M_{n,Rd} = \begin{cases} 19.76 \text{ kN.m (Case2)} \\ 26.06 \text{ kN.m (Case4)} \end{cases}$$

Resistance of Composite Sections in Compression

Moment of inertia of the steel reinforcement about Y-axis:

$$I_s = \frac{6\pi\phi^4}{64} + \frac{4\pi\phi^2}{4} \left[\frac{h_a}{2} - \left(20 + \frac{\phi}{2}\right) - t_f \right]$$

$$I_s = \begin{cases} 2.098 \cdot 10^7 \text{ mm}^4 \text{ (Case2)} \\ 3.759 \cdot 10^7 \text{ mm}^4 \text{ (Case4)} \end{cases}$$

Moment of inertia of the concrete about Y-axis:

$$I_c = \frac{bh_a^3}{12} - I_a - I_s$$

$$I_c = \begin{cases} 4.945 \cdot 10^8 \text{ mm}^4 \text{ (Case2)} \\ 9.947 \cdot 10^8 \text{ mm}^4 \text{ (Case4)} \end{cases}$$

Characteristic plastic resistance of the composite section in compression (clause 6.7.3.3(2) of **[10]**):

$$N_{pl,Rk} = A_a f_y + 0.85 A_c f_{ck} + A_s f_{sk}$$

$$N_{pl,Rk} = \begin{cases} 7.329 \cdot 10^3 \text{ kN (Case2)} \\ 6.661 \cdot 10^3 \text{ kN (Case4)} \end{cases}$$

Plastic resistance of the composite section in compression (clause 6.7.3.2(1) of **[10]**):

$$N_{pl,Rd} = A_a f_y + 0.85 A_c \frac{f_{ck}}{1.5} + A_s \frac{f_{sk}}{1.15}$$

$$N_{pl,Rd} = \begin{cases} 6.542 \cdot 10^3 \text{ kN (Case2)} \\ 5.851 \cdot 10^3 \text{ kN (Case4)} \end{cases}$$

Elastic critical normal force for the buckling mode:

$$N_{cr} = \frac{\pi^2 EI}{L^2}$$

$$N_{cr} = \begin{cases} 4.275 \cdot 10^4 \text{ kN (Case2)} \\ 8.380 \cdot 10^4 \text{ kN (Case4)} \end{cases}$$

The effective flexural stiffness EI is determined in accordance with (clause 7.7.2(4) of [8]):

$$EI = 0.9(E_a I_a + 0.5 E_c I_c + E_a I_s)$$

$$EI = \begin{cases} 5.306 \cdot 10^{13} \text{ N.mm}^2 \text{ (Case2)} \\ 1.040 \cdot 10^{14} \text{ N.mm}^2 \text{ (Case4)} \end{cases}$$

Steel distribution ratio is defined as (clause 6.7.3.3(1) of [10]):

$$\delta = \frac{A_a f_y}{N_{pl,Rd}}$$

$$\delta = \begin{cases} 0.675 \text{ (Case2)} \\ 0.639 \text{ (Case4)} \end{cases}$$

Where $0.2 < \delta < 0.9$ (clause 6.7.1(4) of [10])

Resistance of Composite Columns in Combined Compression and Uniaxial Bending under the Seismic Combination

The columns shall be verified in compression considering the most unfavourable combination of the axial force and bending moments. In the checks (clause 6.6.3(1) of [8]), N_{Ed} , M_{Ed} , V_{Ed} should be computed as:

$$N_{Ed}^* = N_{Ed,G} + 1,1 \gamma_{ov} \Omega N_{Ed,E}$$

$$M_{Ed}^* = M_{Ed,G} + 1,1 \gamma_{ov} \Omega M_{Ed,E}$$

$$V_{Ed}^* = V_{Ed,G} + 1,1 \gamma_{ov} \Omega V_{Ed,E}$$

The indices G and E correspond to gravity and seismic loads respectively. Ω is the minimum value, of all beams in which dissipative zones are located, given by the following expression;

$$\Omega = \min_i \left\{ \Omega_i = M_{pl,Rd,i} / |M_{Ed}|_{\max,i} \right\}$$

$$\Omega = \frac{339}{330} = 1.191 \text{ (Case2)}$$

$$\Omega = \frac{337}{362} = 1.286 \text{ (Case4)}$$

The index "i" covers all beams, MEd is the design value of the bending moment in beam in the seismic design situation and MPI,Rd is the corresponding plastic moment, and where the material overstrength factor γ_{ov} is equal to 1.25 (clause 6.2(4) of [8]).

Where there is a normal force, we have to take into account its effects on the plastic moment resistance. For cross-sections of classes 1 and 2, the following expression must be satisfied (clause 4.8.3.13(8) of [15]): $M_{Ed} \leq \alpha_M M_{N,Rd}$ but $\alpha_M M_{N,Rd} \leq M_{pl,Rd}$

The coefficient α_M should be taken as 0.9 for steel grades between S235 and S355 inclusive, and as 0.8 for steel grades S420 and S460 (clause 6.7.3.6(1) of [10]).

The plastic moment resistance $M_{N,Rd}$, reduced by the force normal NEd, is given by the following expression, (Clause 6.5.3 of [11]):

$$M_{N,Y,Rd} = M_{pl,Rd} \frac{N_{pl,Rd} - N_{Ed}^*}{N_{pl,Rd} - N_{pm,Rd}}$$

$$M_{N,Y,Rd} = \begin{cases} 659.62 \frac{6542 - N_{Ed}^*}{6542 - 1339} & \text{(Case2)} \\ 718.03 \frac{5851 - N_{Ed}^*}{5851 - 1407} & \text{(Case4)} \end{cases}$$

The resistance check in combined compression and uniaxial bending has been done for the columns, located at the base, which are subjected to the maximum axial forces and moments in seismic design situation. The tables, shown below, provide the values of forces and moments at upper and lower extremities of columns. For all cases, the condition $M_{Ed} \leq 0.9M_{N,Rd}$ is largely satisfied.

Case 2: high seismicity – composite columns

		$N_{Ed,G}$	$M_{Ed,G}$	$N_{Ed,E}$	$M_{Ed,E}$	N_{Ed}^*	M_{Ed}^*	$M_{N,y,Rd}$	α_M $M_{N,y,Rd}$
End		kN	kNm	kN	kNm	kNm	kNm	kNm	kNm
Col.1	lower	-811	-39	119	130	-615	174	751	676
	upper	-805	76	119	-46	-610	0.5	752	677
Col.2	lower	-1668	2	-12	148	-1687	245	616	554
	upper	-1663	-4	-12	-83	-1682	-139	617	555
Col.3	lower	-1668	-2	11	148	-1650	241	620	558
	upper	-1663	4	11	-82	-1645	-131	621	559
Col.4	lower	-811	39	-119	129	-1005	250	702	632
	upper	-805	-76	-119	-45	-1000	-150	702	632

Case 4: low seismicity – composite columns

		$N_{Ed,G}$	$M_{Ed,G}$	$N_{Ed,E}$	$M_{Ed,E}$	N_{Ed}^*	M_{Ed}^*	$M_{N,y,Rd}$	α_M $M_{N,y,Rd}$
End		kN	kNm	kN	kNm	kNm	kNm	kNm	kNm
Col.1	lower	-829	-43	57	72	-728	84	828	745
	upper	-822	82	57	-16	-721	54	829	746
Col.2	lower	-1667	0.3	-4	81	-1674	143	674	607
	upper	-1661	-2	-4	-34	-1667	-61	676	608
Col.3	lower	-1667	-0.3	3	80	-1661	142	677	609
	upper	-1661	2	3	-33	-1654	-57	678	610
Col.4	lower	-829	43	-57	71	-929	169	796	716
	upper	-822	-82	-57	-15	-923	-109	797	717
Col.20	upper	-161	-175	-5	-17	-170	-206	918	826

Note: In case 4 (zone of low seismicity), we noted that column number 20 is subjected to the maximum bending moment in seismic design situation as well as in static design situation, which shows that seismic actions has not an important effect on the building with respect to the permanent and transient actions.

Resistance of Composite Columns in Combined Compression and Uniaxial Bending under the Critical Fundamental Combination

The resistance check in combined compression and uniaxial bending has been done for the columns number 2 and number 20 which are subjected to maximum axial forces and moments respectively in static design situation. The tables, shown below, provide the values of normal forces and moments where the condition $M_{Ed} \leq 0.9M_{N,Rd}$ is largely satisfied

Case 2: high seismicity – composite columns

		N_{Ed}	M_{Ed}	$M_{N,y,Rd}$	$\alpha_M M_{N,y,Rd}$
	End	kNm	kNm	kNm	kNm
Col.2	lower	2001	86	576	518
Col.20	upper	208	222	803	723

Case 4: low seismicity – composite columns

		N_{Ed}	M_{Ed}	$M_{N,y,Rd}$	$\alpha_M M_{N,y,Rd}$
	End	kNm	kNm	kNm	kNm
Col.2	lower	1998	91	623	560
Col.20	upper	213	244	911	820

Reduction Factor for Flexural Buckling about Y-Axis

For the elements subjected to axial compression, it is appropriate that the value of axial force meets the following condition (clause 6.7.3.5(2) of [10]): $N_{Ed} \leq \chi N_{pl,Rd}$

The relative slenderness for the plane of bending being considered is given by (Clause 6.7.3.3(2) of

$$\bar{\lambda} = \sqrt{\frac{N_{pl,Rk}}{N_{cr}}}$$

[10]) or (clause 5.5.1.2(1) of [15]):

$$\bar{\lambda} = \begin{cases} 0.414 < 2.0 & \text{(Case2)} \\ 0.282 < 2.0 & \text{(Case4)} \end{cases} \quad \text{(clause 6.7.3.1(1) of [10])}$$

The reduction factor for the buckling mode is given by clause 6.3.1.2. in the EN 1993-1-1 (clause 6.7.3.5(2) of [10]):

$$\chi = \frac{1}{\phi + \sqrt{\phi^2 - \bar{\lambda}^2}} \quad \text{but } \chi \leq 1$$

$$\chi = \begin{cases} 0.920 & \text{(Case2)} \\ 0.982 & \text{(Case4)} \end{cases}$$

$$\phi = 0.5 * \left[1 + \alpha * (\bar{\lambda} - 0.2) + \bar{\lambda}^2 \right]$$

$$\phi = \begin{cases} 0.622 \text{ (Case2)} \\ 0.548 \text{ (Case4)} \end{cases}$$

Ø is given as follows:

For buckling about Y-axis, the imperfection factor, α :

For case 2: $\frac{h}{b} = 1.03 < 1.2$ and $t_f = 15.5 \text{ mm} < 100 \text{ mm} \Rightarrow \alpha = 0.34$ (courbe b)

For case 4: $\frac{h}{b} = 1.3 > 1.2$ and $t_f = 19 \text{ mm} < 40 \text{ mm} \Rightarrow \alpha = 0.21$ (courbe a)

This check, which has been done for the column number 2 which is subjected to the maximum axial force in persistent and transient design situation, is largely satisfied.

$$N_{Ed} = \begin{cases} 2001.4 \text{ kN} < \chi N_{pl,Rd} = 6018.60 \text{ kN (Case2)} \\ 1998.4 \text{ kN} < \chi N_{pl,Rd} = 5745.70 \text{ kN (Case4)} \end{cases}$$

It is necessary that the following condition is satisfied for all composite columns (clause 7.7.3(7) of **[8]**);

$$\frac{N_{Ed}}{N_{pl,Rd}} < 0.3$$

This check has been done for the column number 2 which is subjected to the maximum axial forces in seismic design situation.

$$\frac{N_{Ed}}{N_{pl,Rd}} = \begin{cases} \frac{1687}{6542} = 0.26 < 0.3 \text{ (Case2)} \\ \frac{1674}{5851} = 0.29 < 0.3 \text{ (Case4)} \end{cases}$$

Shear Resistance of Composite Sections

It is allowed to assume that the shear force V_{sd} is applied only on the steel profile (clause 4.8.3.12 of **[15]**). The design plastic shear resistance $V_{pl,a,Rd}$ of the structural steel section should be determined in accordance with clause 6.2.6 of EN 1993-1-1 (clause 6.2.2(2) of **[8]**).

Noting that $\frac{h_w}{t_w} = \begin{cases} 31.00 < 72\varepsilon = 58.58 \text{ (Case2)} \\ 30.61 < 72\varepsilon = 72.00 \text{ (Case4)} \end{cases}$

Thus sections are classified into class 1 where there is no local buckling, and according to (clause 6.2.6(1),(2) and (6) of **[12]**) we have:

$$V_{pl,a,Rd} = \frac{A_v * f_y}{\sqrt{3}} = \begin{cases} 843.00 \text{ kN (Case2)} \\ 777.84 \text{ kN (Case4)} \end{cases}$$

The check of shear resistance has been done for the columns, number 8 (for case 2_seismic combination) and number 17 (for case 4 static combination), which are subjected to the maximum shear forces in seismic and static design situations respectively, where the maximum values are as shown:

(For case2_Sismic design situation)

$$\begin{aligned}
 |V_{Ed,G}|_{\max} &= 55.54 \text{ kN} \\
 |V_{Ed,E}|_{\max} &= \frac{1}{1-\theta} * 39.43 = \frac{1}{1-0.057} * 39.43 \\
 &= 1.06 * 39.43 = 41.80 \text{ kN} \\
 |V_{Ed}^*|_{\max} &= |V_{Ed,G} + 1,1\gamma_{ov}\Omega V_{Ed,E}|_{\max} \\
 |V_{Ed}^*|_{\max} &= 123.99 \text{ kN}
 \end{aligned}$$

(For case4_Static design situation)

$$|V_{Ed}|_{\max} = 121.42 \text{ kN}$$

When the shear force is less than half the plastic shear resistance, the effect on the moment resistance may be neglected (clause 6.2.8(2) of [12]) :

$$V_{Ed,\max} = \begin{cases} 123.99 \text{ kN} < 0.5V_{pl,a,Rd} = 421.50 \text{ kN} \text{ (Case2)} \\ 121.42 \text{ kN} < 0.5V_{pl,a,Rd} = 388.92 \text{ kN} \text{ (Case4)} \end{cases}$$

The shear force has thus no effect on the reduction in combination of moment and axial force (Clause 6.2.10(2) of [12]).

Second order effects of composite columns (static combination)

Within the composite column length and in case of fundamental (static) combinations, second-order effects may be allowed for by multiplying the greatest first-order design bending moment MEd by a factor k given by (Clause 6.7.3.4(5) of [10]):

$$k = \frac{\beta}{1 - N_{ED} / N_{cr,eff}} \geq 1.0$$

Ncr,eff is the critical normal force for the relevant axis and corresponding to the effective flexural stiffness of composite column, with the effective length taken as the column length.

β is an equivalent moment factor given in (Table 6.4 of [10]).

$$\text{Where } \beta = 0.66 + 0.44r \quad \text{but } \beta \geq 0.44 \quad r = \frac{M_{Ed,\min}}{M_{Ed,\max}}, \quad -1 \leq r \leq 1$$

MEd,max and MEd,min are the end moments from first order or second-order global analysis.

The check has been done for the columns, located at the base, which are subjected to the maximum axial forces in persistent or transient design situation. The tables below provide values of the k factor which are clearly shown smaller than (1.0).

Case 2: high seismicity – composite columns

		M_{Ed}	r	β	N_{Ed}	$N_{cr,eff}$	k
	Extremity	kN.m			kN	kN	
column 1	lower	36	0.529	0.893	917	42750	0.913
	upper	68					
column 2	lower	86	-0.674	0.440	2001	42750	0.462
	upper	-58					
column 3	lower	81	-0.593	0.440	1991	42750	0.461
	upper	-48					
column 4	lower	120	-0.960	0.440	1018	42750	0.451
	upper	-125					

Case 4: low seismicity – composite columns

		M_{Ed}	r	β	N_{Ed}	$N_{cr,eff}$	k
	Extremity	kN.m			kN	kN	
column 1	lower	39	0.476	0.870	943	83800	0.880
	upper	82					
column 2	lower	91	-0.538	0.440	1998	83800	0.451
	upper	-49					
column 3	lower	89	-0.483	0.447	1992	83800	0.458
	upper	-43					
column 4	lower	132	-0.947	0.440	1040	83800	0.446
	upper	-125					

5.17.8 GLOBAL AND LOCAL DUCTILITY CONDITION

The plastic resistance of columns subjected to combined bending and axial compression are known, and in accordance with the value of behavior factor, it is important to ensure that the actual ruin of the structure will be based on the occurrence of a global plastic mechanism (and not on a local mechanism in one or two levels). This is clearly indicated, for steel and composite structures, by Eurocode 8. At each node of the structure, the strong-column, weak-beam condition shall be satisfied by applying the following inequality (Clause 4.4.2.3 of [8]);

$$\sum_c M_{N,pl,Rd,c} \geq 1,3 \sum_b M_{pl,Rd,b}$$

\sum_c corresponds to the sum of design values of the moments of resistance of the columns and

\sum_b to that of beams at the considered node.

The nodes where columns have the weakest resistance are nodes 2 and 3, as confirmed in the first table below, and the total resistance of columns (at each of these nodes) is greater than 1.3 times of that of beams as shown in table the second table.

Case 1: high seismicity – steel columns

		$N_{Ed,G}$	$M_{Ed,G}$	$N_{Ed,E}$	$M_{Ed,E}$	N_{Ed}^*	M_{Ed}^*	$M_{N,y,Rd}$
	Extremity	kN	kNm	kN	kNm	kN	kNm	kNm
Column 2	upper	-1648	-3	-8	-76	-1663	-130	574
Column 3	upper	-1648	-3	8	-76	-1634	-129	579
Column 6	lower	-1389	4	-6	132	-1400	224	618
Column 7	Lower	-1389	-4	6	132	-1380	216	622

	$M_{plRd,b}^{gauche}$ (kNm)	$M_{plRd,b}^{droite}$ (kNm)	$M_{N,plRd,c}^{inférieur}$ (kNm)	$M_{N,plRd,c}^{supérieur}$ (kNm)	$\frac{M_{N,plRd,c}^{inférieur} + M_{N,plRd,c}^{supérieur}}{M_{plRd,b}^{gauche} + M_{plRd,b}^{droite}}$
Node 2	393	495	574	618	1.34
Node 3	393	495	579	622	1.35

Case 2: high seismicity – composite columns

		$N_{Ed,G}$	$M_{Ed,G}$	$N_{Ed,E}$	$M_{Ed,E}$	N_{Ed}^*	M_{Ed}^*	$\alpha_M M_{N,y,Rd}$
	Extremity	kN	kNm	kN	kNm	kN	kNm	kNm
Column 2	upper	-1663	-4	-12	-83	-1682	-139	555
Column 3	upper	-1663	-4	11	82	-1645	139	559
Column 6	lower	-1417	6	-8	130	-1431	219	583
Column 7	Lower	-1417	-5	8	130	-1404	207	586

	$M_{plRd,b}^{gauche}$ (kNm)	$M_{plRd,b}^{droite}$ (kNm)	$\alpha_M M_{N,plRd,c}^{inférieur}$ (kNm)	$\alpha_M M_{N,plRd,c}^{supérieur}$ (kNm)	$\frac{\alpha_M [M_{N,plRd,c}^{inférieur} + M_{N,plRd,c}^{supérieur}]}{M_{plRd,b}^{gauche} + M_{plRd,b}^{droite}}$
Node 2	393	495	555	583	1.30
Node 3	393	495	559	586	1.30

Case 3: low seismicity – steel columns

		$N_{Ed,G}$	$M_{Ed,G}$	$N_{Ed,E}$	$M_{Ed,E}$	N_{Ed}^*	M_{Ed}^*	$M_{N,y,Rd}$
	Extremity	kN	kNm	kN	kNm	kN	kNm	kNm
Column 2	upper	-1645	-1	-3	-29	-1650	-53	536
Column 3	upper	-1645	1	2	-29	-1641	-52	538
Column 6	lower	-1321	3	-2	63	-1325	-117	605
Column 7	Lower	-1321	-3	2	63	-1319	111	606

	$M_{plRd,b}^{gauche}$ (kNm)	$M_{plRd,b}^{droite}$ (kNm)	$M_{N,plRd,c}^{inférieur}$ (kNm)	$M_{N,plRd,c}^{supérieur}$ (kNm)	$\frac{M_{N,plRd,c}^{inférieur} + M_{N,plRd,c}^{supérieur}}{M_{plRd,b}^{gauche} + M_{plRd,b}^{droite}}$
Node 2	337	414	536	605	1.52
Node 3	337	414	538	606	1.52

Case 4: low seismicity – composite columns

		$N_{Ed,G}$	$M_{Ed,G}$	$N_{Ed,E}$	$M_{Ed,E}$	N_{Ed}^*	M_{Ed}^*	$\alpha_M M_{N,y,Rd}$
	Extremity	kN	kNm	kN	kNm	kN	kNm	kNm
Column 2	upper	-1661	-2	-4	-34	-1667	-61	608
Column 3	upper	-1661	2	3	-33	-1654	-57	610
Column 6	lower	-1335	4	-3	62	-1340	114	656
Column 7	Lower	-1335	-4	2	62	-1331	105	657

	$M_{plRd,b}^{gauche}$ (kNm)	$M_{plRd,b}^{droite}$ (kNm)	$\alpha_M M_{N,plRd,c}^{inférieur}$ (kNm)	$\alpha_M M_{N,plRd,c}^{supérieur}$ (kNm)	$\frac{\alpha_M [M_{N,plRd,c}^{inférieur} + M_{N,plRd,c}^{supérieur}]}{M_{plRd,b}^{gauche} + M_{plRd,b}^{droite}}$
Node 2	337	414	608	656	1.68
Node 3	337	414	610	657	1.69

References

- [1] NF, EN 1991-1-1: "Actions on structures; general actions - densities, self-weights, imposed loads for buildings". March 2003.
- [2] NF, P, 06-111-2: " National Annex for NF, EN 1991-1-1:2003. June 2004.
- [3] NF, EN 1991-1-3: "Actions on structures; general actions – Snow loads". April 2004.
- [4] NF, EN 1991-1-3 / NA: " National Annex for NF, EN 1991-1-3:2004. June 2004.
- [5] NBN, ENV 1991-2-4: " Basis of calculation and Actions on structures: Actions on structures – Wind loads including the Belgian application document". October 2002.
- [6] NF, EN 1991-1-4: "Actions on structures; general actions – Wind loads". November 2005.
- [7] NF, EN 1990: "Eurocode; Basis of structural design ". March 2003.
- [8] NF, EN 1998-1: "Design of structures for earthquake resistance – general rules, seismic actions and rules for buildings". September 2005.
- [9] PLUMIER, A. (2007): "Construction in seismic zones". University of Liege, Liege, Belgium
- [10] NF, EN 1994-1-1: "Design of composite steel and concrete structures – general rules and rules for buildings ". June 2005
- [11] MANFRED, A. et al. (2006): "metallic construction". Switzerland
- [12] NF, EN 1993-1-1: "Design of steel structures – general rules and rules for buildings ". October 2005
- [13] NF, EN 1992-1-1: "Design of concrete structures – general rules and rules for buildings ". October 2005
- [14] ARIBERT et al: " Exemple simple de dimensionnement sismique d'un portique en acier selon l'Eurocode 8-1". INSA de Rennes
- [15] NF P22-391 – National application document of the ENV 1994-1-1 "Design of composite steel and concrete structures – general rules and rules for buildings ". September 1994.
- [16] NF P22-311 – National application document of the ENV 1993-1-1 "Design of steel structures – general rules and rules for buildings ". December 1994.
- [17] ARIBERT et al: " Proposition d'un nouveau critère de sensibilité aux effets du 2e ordre et de la méthode associée de calcul simplifiée pour les portiques en acier soumis a une action sismique horizontale". INSA de Rennes

Specific rules for the design and detailing of steel buildings:

**(iii) Composite steel concrete frame with eccentric and concentric
bracings**

H. Degee and A. Plumier

University of Liege

5.18 Definition of the structure

5.18.1 DIMENSIONS, MATERIAL PROPERTIES AND EARTHQUAKE ACTION

Dimensions

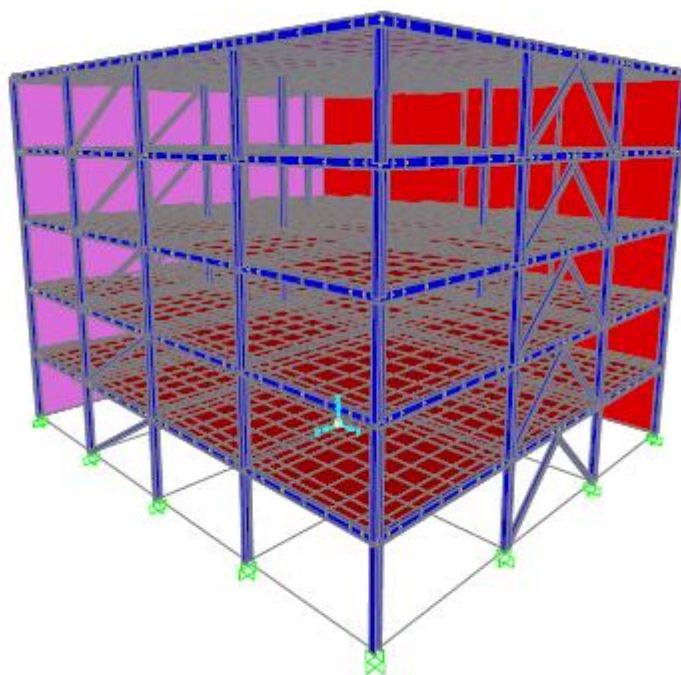
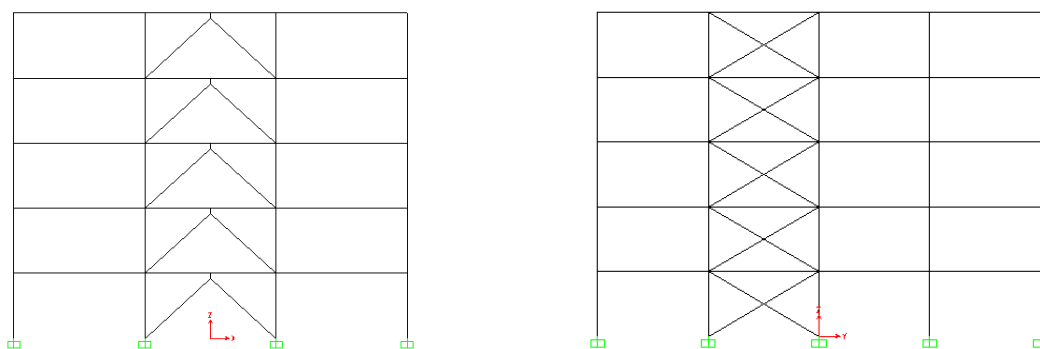

Fig. 5.18.1 3D view of the 5 storey building



View of the building – X-direction – Eccentric bracings

View of the building – Y-direction – Concentric bracings

Fig. 5.18.2 The office building and its bracings

Dimensions	Symbol	Value	Units
Storey height	h	3.5	m
Total height of the building	H	17.5	m
Beam length in X-direction (Eccentric bracings)	l_x	7	m
Beam length in Y-direction (Concentric bracings)	l_y	6	m
Building width in X-direction	L_x	21	m
Building width in Y-direction	L_y	24	m

Material properties

Concrete: C30/35

Steel profile: S355

Steel rebars: S500

Details of values			
Dimensions	Symbol	Value	Units
Characteristic yield strength of reinforcement steel	f_s	500	N/mm ²
Partial factor for steel rebars	γ_s	1.15	
Design yield strength of reinforcement steel	f_{sd}	434.78	N/mm ²
Characteristic compressive strength of concrete	f_c	30	N/mm ²
Partial factor for concrete	γ_c	1.5	
Coefficient taking account of long term effects on the compressive strength and of unfavourable effects resulting from the way the load is applied	α_{cc}	1	
Design compressive strength of concrete	f_{cd}	20	N/mm ²
Secant modulus of elasticity of concrete for the design under gravity loads combinations	E_c	33000	N/mm ²
Secant modulus of elasticity of concrete for the design under seismic loads combination	$E_{c,sc}$	16500	N/mm ²
Characteristic yield strength of steel profile	f_y	355	N/mm ²
Partial factor for steel profile	γ_y	1	
Modulus of elasticity of steel profile	E_a	210000	N/mm ²

The yield strength of the steel profile is reduced when the thickness is greater than 16 mm:

if $\max(t_{\text{flange}}; t_{\text{web}}) \leq 16 \text{ mm}$ \rightarrow $f_y = 355 \text{ N/mm}^2$

if $16 \text{ mm} < \max(t_{\text{flange}}; t_{\text{web}}) \leq 40 \text{ mm}$ \rightarrow $f_y = 345 \text{ N/mm}^2$

Earthquake action

The earthquake action is specified according to Eurocode 8 and characterised as follows:

design ground acceleration of 0.25g

soil type B

type 1 response spectrum

DCM design with a behaviour factor $q = 4$

Parameters describing the recommended Type 2 elastic response spectra (ground type C)			
Dimensions	Symbol	Value	Unit
Soil factor	S	1.2	
Lower limit of period of constant spectral acceleration branch	T_B	0.15	s
Upper limit of period of constant spectral acceleration branch	T_C	0.5	s
Beginning of the constant displacement response range	T_D	2	s

Combinations of actions

Loads considered:

Permanent actions + self-weight of the slab $G = 5.858 \text{ kN/m}^2$

Variable actions $Q = 3 \text{ kN/m}^2$

Snow $S = 1.11 \text{ kN/m}^2$

Wind $W = 1.4 \text{ kN/m}^2$

Gravity loads combinations:

1. $1.35G + 1.5 W + 1.5 (0.7Q + 0.5S)$
2. $1.35G + 1.5 Q + 1.5 (0.7W + 0.5S)$
3. $1.35G + 1.5 Q + 1.5 (0.7S + 0.5W)$
4. $1.35G + 1.5 S + 1.5 (0.7Q + 0.5W)$
5. $1.35G + 1.5 S + 1.5 (0.7W + 0.5Q)$
6. $1.35G + 1.5 W + 0.7 \cdot 1.5 (Q + S)$
7. $1.35G + 1.5 (Q + S) + 0.7 \cdot 1.5 (W)$

Seismic combination.

$$1G + \psi_{2i} Q + E \quad \text{with } \psi_{2i} = 0.3 \text{ given in Eurocode 1990}$$

E = action effects from the analysis under seismic action applied to a structure of seismic mass m

The inertial effects of the design seismic action shall be evaluated by taking into account the presence of the masses associated with all gravity loads appearing in the following combination of actions:

$$m = \sum G_{kj} + \sum \psi_{Ei} \cdot Q_{ki}$$

The coefficient $\psi_{E,i}$ is used to estimate a likely value of service loads and to take into account that some masses do not follow perfectly the moves of the structure, because they are not rigidly connected to the structure.

$\psi_{E,i}$ is computed as:
$$\psi_{Ei} = \phi \cdot \psi_{2i}$$

Values of $\psi_{2,i}$ and ϕ are given in Eurocodes 0 and 8. For this office building with correlated occupancies, $\phi = 0.8$ and $\psi_{Ei} = \phi \cdot \psi_{2i} = 0,8 \times 0,3 = 0,24$

5.18.2 STEPS OF THE DESIGN DETAILED IN THIS REPORT

Design of slab under gravity loads (without EBF bracings) considering columns as fixed supports

Design of columns under gravity loads (without EBF bracings)

Design of beams under gravity loads (without EBF bracings)

Accidental torsional effects

Second order effects (P- Δ) [P loads are those taken in the definition of the seismic mass m]

Design of eccentric bracings under seismic combination of loads, with the accidental torsional effects and P- Δ effects taken into account

Check of beams and of eccentric bracings under gravity loads combination (EBF create an additional support to the beam)

Design of one link connection

Design of concentric bracings under seismic combination of loads and with the accidental torsional effects and P- Δ effects taken into account

Check of beams and columns under seismic combination of loads with bracings overstrength factors Ω and with second order effects taken into account

Design of one diagonal connection

Check of diaphragm

Check of secondary elements

5.18.3 FINITE ELEMENT MODEL IN 3 DIMENSIONS

The software SAP 2000 is used to analyse the building in 3 dimensions. It takes into account:

- distribution of mass (G + 0.24 Q) and stiffness;
- eventual 3D effect;

The second moment of area of the composite beams is considered in the analysis.

5.18.4 TYPE OF FRAME

This building has 2 types of bracings:

- Eccentric in the direction X, along the 21m side length
- Concentric in the direction Y, along the 24m side length

5.18.5 FINAL CHARACTERISTICS OF THE BUILDING

After several iterations, the final design of the composite building provides the following sections:

Reinforced concrete slab thickness = 18 cm

Composite beam steel profiles: IPE 270

Columns steel profiles: HE 260 B + HE 280 B

Concentric bracings steel profiles: UPE

Eccentric bracings steel profiles: HE

The 2 fundamental periods of the structure according to the direction are computed by a modal analysis realised by the software SAP2000:

In direction X (21m): $T_x = 0.827$ s

In direction Y (24m): $T_y = 1.454$ s

The total mass of the building is 1744 tons.

Results in this report are obtained with beams considered composite in main span, but not connected to columns; in this way, the primary resisting system for earthquake action are the bracings; the moment frames remain secondary; this simplify the project. This option is allowed and a disconnection rule is provided at clause 7.7.5 of Eurocode EN 1998.

Slab design under gravity loads

The slab is not a composite one but a reinforced concrete slab. The slab thickness h_{slab} is taken equal to 180 mm, with a cover of steel rebars equal to 20 mm. Steel rebars of the slab are chosen to provide the required resistant bending moments on support and in span in the 2 directions X and Y. These internal values are given with fixed supports of the slab (the slab is only discontinuous at beam-column connections but is continuous between these supports). A welded mesh with bars of diameter 10 mm is placed in upper and lower layers of the slab. Some additional rebars are placed in direction X where bending moments are greater.

Characteristics of slabs						
X-direction						
	Applied bending moment $M_{Ed,slab,X,GC}$	Resistant bending moment $M_{Rd,slab,X}$	Rebars for 1m of slab	Steel Section $A_{s,X}$	Spacing of rebars	Free spacing between rebars
Unit	[kNm/m]	[kNm/m]	[mm]	[mm ² /m]	[mm]	[mm]
SPAN (lower layer of rebars)	66.53	73.18	10 T10 + 2 T16	1187.5	100 – 50	90 – 37
SUPPORT (upper layer of rebars)	92.40	94.85	10 T10 + 4 T16	1585.65	100 – 50	90 – 37

Y-direction						
	Applied bending moment $M_{Ed,slab,Y,GC}$	Resistant bending moment $M_{Rd,slab,Y}$	Rebars for 1m of slab	Steel Section $A_{s,Y}$	Spacing of rebars	Free spacing between rebars
	[kNm/m]	[kNm/m]	[mm]	[mm ² /m]	[mm]	[mm]
SPAN (lower layer of rebars)	35.39	49.93	10 T10	785.4	100	90
SUPPORT (upper layer of rebars)	41.67	49.93	10 T10	785.4	100	90

5.19 Design of the slabs under gravity loads

5.19.1 BENDING RESISTANCE OF SLABS

The bending resistance is calculated by an iterative process, according to the following assumptions:

A parabola-rectangle constitutive law is considered for concrete [EN 1992-1-1 Fig.3-3];

An elastic-perfectly-plastic law is considered for rebars; concrete has no resistance in tension; ULS is obtained when the compressive strain in concrete is equal to $\epsilon_{cu} = 0.0035$.

5.19.2 SHEAR RESISTANCE OF SLABS

$V_{Rd,c}$ is the design shear resistance of the member without shear reinforcement. The minimum value of $V_{Rd,c}$ is given in EN 1992, clause 6.2.2 (1), by:

$$V_{Rd,c,min} = (v_{min} + k_1 \sigma_{cp}) b_w d \quad \text{where } v_{min} = 0.035 k^{3/2} f_{ck}^{1/2}$$

$$k = 1 + \sqrt{\frac{200}{d}} \leq 2.0 \quad \text{with } d \text{ in mm}$$

$$\sigma_{cp} = N_{Ed}/A_c < 0,2 f_{cd} \text{ [MPa]}, \text{ with } N_{Ed} = 0 \rightarrow \sigma_{cp} = 0$$

b_w is the smallest width of the cross-section in the tensile area [mm] = 1m

d is the effective depth of a cross-section: $d = 155 \text{ mm}$

$$V_{Rd,c,min,X} = 92.8 \text{ kN} > V_{Ed,slab,X} = 58.6 \text{ kN} \Rightarrow \text{OK}$$

$$V_{Rd,c,min,Y} = 92.8 \text{ kN} > V_{Ed,slab,Y} = 36.8 \text{ kN} \Rightarrow \text{OK}$$

5.19.3 DEFLECTION OF THE SLAB

[EN 1992-1-1: 2004 cl. 7.4.1 (4)]

The deflexion of the slab has to be limited, according to directions X and Y: deflection $\leq L_{slab}/250$

According to X-direction: deflexion = 0.018 m $< l_x/250 = 0.028 \text{ m} \Rightarrow \text{OK}$

According to Y-direction: deflexion = 0.018 m $< l_y/250 = 0.024 \text{ m} \Rightarrow \text{OK}$

5.19.4 EUROCODE 2 CHECKS

Minimum longitudinal reinforcement

The area of longitudinal reinforcement should not be less than $A_{s,min}$. The value of $A_{s,min}$ for use in a Country may be found in its National Annex. The recommended value is given by:

$$A_{s,min} = \max \left(0.26 \frac{f_{ctm}}{f_{yk}} b_t d, 0.0013 b_t d \right)$$

Where f_{ctm} is the characteristic value of concrete tensile strength: $f_{ctm} = 2.9 \text{ N/mm}^2$

f_{yk} is the characteristic yield strength of reinforcement steel: $f_{yk} = 500 \text{ N/mm}^2$

b_t is the mean width of the tension zone and is assessed equal to 1m

d is the effective depth of a cross-section: $d = 155 \text{ mm}$

$$A_{s,\min,X} = 233.7 \text{ mm}^2 / \text{m} < A_{s,X} \Rightarrow \text{OK}$$

$$A_{s,\min,Y} = 233.7 \text{ mm}^2 / \text{m} < A_{s,Y} \Rightarrow \text{OK}$$

[EN 1992-1-1: 2004 cl. 9.3.1.1 (1) – 9.2.1.1 (1)]

Maximum longitudinal reinforcement

The area of longitudinal reinforcement should not exceed $A_{s,\max}$. The value of $A_{s,\max}$ for use in a Country may be found in its National Annex. The recommended value is:

$$A_{s,\max} = 0.04 \times A_c$$

Where A_c is the concrete cross section area of the slab: $A_c = 1 \text{ m} \times h_{\text{slab}}$

$$A_{s,\max} = 7200 \text{ mm}^2 / \text{m} > A_{s,X} \Rightarrow \text{OK}$$

$$A_{s,\max} = 7200 \text{ mm}^2 / \text{m} > A_{s,Y} \Rightarrow \text{OK}$$

[EN 1992-1-1: 2004 cl. 9.3.1.1 (1) – 9.2.1.1 (3)]

Maximum spacing

The spacing of bars should not exceed $s_{\max,\text{slab}}$. The value of $s_{\max,\text{slab}}$ for use in a Country may be found in its National Annex. The recommended value is: $s_{\max,\text{slab}} = \min(3 h_{\text{slab}}, 400 \text{ mm})$

In areas with concentrated loads or areas of maximum moment: $s_{\max,\text{slab,max}} = \min(2 h_{\text{slab}}, 250 \text{ mm})$

Where h_{slab} is the total depth of the slab.

$s_{\max,\text{slab,max}} = 250 \text{ mm} > \text{spacing of rebars according X and Y} \Rightarrow \text{OK}$ [EN 1992-1-1: 2004 cl. 9.3.1.1 (3)]

Minimum spacing

The clear distance (horizontal and vertical) between individual parallel bars or horizontal layers of parallel bars should be not less than: $s_{\min,\text{slab}} = \text{Max}(T_{1b}, T_{2b}, 20 \text{ mm})$

Where T_{1b} and T_{2b} are the diameter of the bars into consideration.

$s_{\min,\text{slab,max}} = 20 \text{ mm} < \text{spacing of rebars according X and Y} \Rightarrow \text{OK}$ [EN 1992-1-1: 2004 cl. 8.2 (2)]

5.20 Design of the columns under gravity loads

5.20.1 STEEL PROFILES

After several iterations with formula and checks detailed further, the steel profile that resist to all gravity loads combinations is an HE 260 B, whose dimensions and resistances are detailed hereafter.

Dimensions	Symbol	Value	Units
Column section height	h_{pc}	260	mm
Column section width	b_{pc}	260	mm
Column flange thickness	t_{fc}	17.5	mm
Column web thickness	t_{wc}	10	mm
Column area	A_{pc}	11840	mm ²
Column shear area	A_{vzc}	3759	mm ²
Column second moment of area – strong axis	I_{pc}	$14920 \cdot 10^4$	mm ⁴
Column second moment of area – weak axis	I_{pcz}	$5135 \cdot 10^4$	mm ⁴
Column plastic section modulus – strong axis	W_{ply}	$1283 \cdot 10^3$	mm ³
Column plastic section modulus – weak axis	W_{plz}	602 200	mm ³
Column warping constant	I_w	$753.7 \cdot 10^9$	mm ⁶
Column torsion constant	I_t	$123.8 \cdot 10^4$	mm ⁴

Resistances	Symbol - Formula	Value	Units
Compression resistance of steel section	$N_{Rd,col} = A_{pc} f_y$	4203	kN
Moment resistance of steel section – strong axis	$M_{Rdy,col} = W_{ply} f_y$	4555	kNm
Moment resistance of steel section – weak axis	$M_{Rdz,col} = W_{plz} f_y$	213.8	kNm
Shear resistance of steel section – strong axis	$V_{Rdy,col} = \frac{f_y A_{vzc}}{\sqrt{3}}$	770	kN
Shear resistance of steel section – weak axis	$V_{Rdz,col} = \frac{2b_{pc} t_{fc} f_y}{\sqrt{3}}$	1865	kN

5.20.2 ACTION EFFECTS UNDER GRAVITY LOADS COMBINATIONS

Maximum values from gravity combinations of actions			
Internal actions in the column	Symbol	Value	Units
Compression force	$N_{Ed,col,GC}$	2984	kN
<u>Strong axis</u>			
Bending moments	$M_{Ed1,col,GC}$	-0.009	kNm
	$M_{Ed2,col,GC}$	0.002	kNm
Maximum shear load	$V_{Edy,col,GC}$	0.009	kN
<u>Weak axis</u>			
Bending moments	$M_{Ed1z,col,GC}$	-0.004	kNm
	$M_{Ed2z,col,GC}$	0.007	kNm
Maximum shear load	$V_{Edz,col,GC}$	0.004	kN

5.20.3 BENDING AND SHEAR INTERACTION CHECK [EN 1993-1-1: 2005 CL. 6.2.8]

Strong axis	
Coefficient of interaction	$Int_{V_y} := \frac{V_{Edy,col,GC}}{V_{Rdy,col}}$
Reduced design value of the resistance to bending moments making allowance for the presence of shear forces	$M_{Rdy,redV} := \begin{cases} M_{Rdy,col} \left[1 - \left(2 \cdot \frac{V_{Edy,col,GC}}{V_{Rdy,col}} + -1 \right)^2 \right] & \text{if } Int_{V_y} > 0.5 \\ M_{Rdy,col} & \text{if } 0 \leq Int_{V_y} \leq 0.5 \end{cases}$
Weak axis	
Coefficient of interaction	$Int_{V_z} := \frac{V_{Edz,col,GC}}{V_{Rdz,col}}$
Reduced design value of the resistance to bending moments making allowance for the presence of shear forces	$M_{Rdz,redV} := \begin{cases} M_{Rdz,col} \left[1 - \left(2 \cdot \frac{V_{Edz,col,GC}}{V_{Rdz,col}} + -1 \right)^2 \right] & \text{if } Int_{V_z} > 0.5 \\ M_{Rdz,col} & \text{if } 0 \leq Int_{V_z} \leq 0.5 \end{cases}$

5.20.4 BENDING AND AXIAL FORCE INTERACTION CHECK [EN 1993-1-1: 2005 CL. 6.2.9]

Factor	$a := \min\left(\frac{A_{pc} - 2 \cdot b_{pc} \cdot t_{fc}}{A_{pc}}, 0.5\right)$
Strong axis	
Coefficient of interaction 1	$Int_1 := \frac{N_{Ed.col.GC}}{0.25 N_{Rd.col}}$
Coefficient of interaction 2	$Int_2 := \frac{N_{Ed.col.GC}}{0.5 h_{pc} \cdot t_{wc} \cdot f_y}$
Coefficient of interaction M-N	$Int_{MN} := \max(Int_1, Int_2)$
Reduced design value of the resistance to bending moments making allowance for the presence of axial forces	$M_{Rdy.redN} := \begin{cases} M_{Rdy.col} \cdot \frac{\left(1 - \frac{N_{Ed.col.GC}}{N_{Rd.col}}\right)}{1 - 0.5a} & \text{if } Int_{MN} > 1 \\ M_{Rdy.col} & \text{if } 0 \leq Int_{MN} \leq 1 \end{cases}$
Weak axis	
Coefficient of interaction M-N	$Int_{MN} := \frac{N_{Ed.col.GC}}{h_{pc} \cdot t_{wc} \cdot f_y}$
Reduced design value of the resistance to bending moments making allowance for the presence of axial forces	$M_{Rdz.redN} := \begin{cases} M_{Rdz.col} \cdot \left[1 - \frac{\left[\frac{N_{Ed.col.GC}}{N_{Rd.col}} + -a\right]^2}{1 - a}\right] & \text{if } Int_{MN} > 1 \\ M_{Rdz.col} & \text{if } 0 \leq Int_{MN} \leq 1 \end{cases}$

5.20.5 BUCKLING CHECK [EN 1993-1-1: 2005 CL. 6.3]

The most unfavourable situation is in a ground column whose nodes are fixed (non mobile nodes). The buckling length is assessed being equal to 0.7 time the storey height.

Buckling length (ground column)	$L_{buck} := 0.7h$

Strong axis	
Elastic critical force for the relevant buckling mode based on the gross cross sectional properties	$N_{\text{cry.col}} := \pi^2 \cdot E_a \cdot \frac{I_{\text{pc}}}{L_{\text{buck}}^2}$
Non dimensional slenderness	$\lambda_y := \sqrt{\frac{N_{\text{Rd.col}}}{N_{\text{cry.col}}}}$
Imperfection factor	$\alpha_y := \begin{cases} 0.206 & \text{if } \frac{h_{\text{pc}}}{b_{\text{pc}}} > 1.2 \\ 0.339 & \text{if } \frac{h_{\text{pc}}}{b_{\text{pc}}} \leq 1.2 \end{cases}$
	$\phi_y := 0.5 \left[1 + \alpha_y \cdot (\lambda_y - 0.2) + \lambda_y^2 \right]$
Reduction factor for the relevant buckling curve	$\chi_y := \frac{1}{\left(\phi_y + \sqrt{\phi_y^2 - \lambda_y^2} \right)}$
Design buckling resistance of a compression member	$N_{\text{uy.col}} := \chi_y \cdot N_{\text{Rd.col}} \quad N_{\text{uy.col}} = 4.075 \times 10^6 \text{ N}$

Weak axis	
Elastic critical force for the relevant buckling mode based on the gross cross sectional properties	$N_{\text{crz.col}} := \pi^2 \cdot E_a \cdot \frac{I_{\text{pcz}}}{L_{\text{buck}}^2}$
Non dimensional slenderness	$\lambda_z := \sqrt{\frac{N_{\text{Rd.col}}}{N_{\text{crz.col}}}}$
Imperfection factor	$\alpha_z := \begin{cases} 0.34 & \text{if } \frac{h_{\text{pc}}}{b_{\text{pc}}} > 1.2 \\ 0.49 & \text{if } \frac{h_{\text{pc}}}{b_{\text{pc}}} \leq 1.2 \end{cases}$
value to determine the reduction factor χ	$\phi_z := 0.5 \left[1 + \alpha_z \cdot (\lambda_z - 0.2) + \lambda_z^2 \right]$
Reduction factor for the relevant buckling curve	$\chi_z := \frac{1}{\left(\phi_z + \sqrt{\phi_z^2 - \lambda_z^2} \right)}$
Design buckling resistance of a compression member	$N_{\text{uz.col}} := \chi_z \cdot N_{\text{Rd.col}} \quad N_{\text{uz.col}} = 3.739 \times 10^3 \text{ kN}$

5.20.6 LATERAL TORSIONAL BUCKLING CHECK

Elastic critical moment for lateral-torsional buckling	
$M_{crLT} := C_1 \cdot \pi^2 \cdot E_a \cdot \frac{I_{pcz}}{k_u \cdot k_\phi \cdot h^2} \cdot \left[\sqrt{(C_2 \cdot y + C_3 \cdot \beta)^2 + \left(1 + \frac{G \cdot J \cdot k_\phi^2 \cdot h^2}{\pi^2 \cdot E_a \cdot I_w} \right) \cdot \left(\frac{I_w}{I_{pcz}} \right)} + (C_2 \cdot y + C_3 \cdot \beta) \right]$	
Non dimensional slenderness for lateral torsional buckling	$\lambda_{LT} := \sqrt{\frac{M_{Rdy.col}}{M_{crLT}}}$
Imperfection factor	$\alpha_{LT} := 0.21$
Value to determine the reduction factor χ_{LT}	$\phi_{LT} := 0.5 \left[1 + \alpha_{LT} (\lambda_{LT} - 0.2) + \lambda_{LT}^2 \right]$
Reduction factor for lateral-torsional buckling	$\chi_{LT} := \frac{1}{\left(\phi_{LT} + \sqrt{\phi_{LT}^2 - \lambda_{LT}^2} \right)}$
Shear modulus	$G := 81000 \frac{N}{mm^2}$
Column torsion constant	$J := I_t$
Factor	$k_u := 1$
Factor	$k_\phi := 1$
Symmetric factor	$\beta := 0m$
Distance between the gravity centre and the loads applied	$y := 0m$
Factor	$C_1 := 1$

5.20.7 INTERACTION CHECKS

CHECK 1: weak axis bending combined with buckling

$\text{Check}_1 := \left[\frac{N_{\text{Ed.col.GC}}}{N_{\text{uz.col}}} + \frac{1}{1 - \frac{N_{\text{Ed.col.GC}}(\lambda_z \cdot \lambda_z)^2}{N_{\text{uz.col}}}} \cdot C_{mz} \frac{M_{\text{Edzmax.col}}}{M_{\text{Rdz.redV}}} \cdot K_{Mz} \right]$	
With:	
The factor	$K_{Mz} := \begin{cases} 0.9 & \text{if } \lambda_z \leq 1 \\ \left[0.9 + 0.5(\alpha_z - 0.9) \cdot (\lambda_z - 1) \right] & \text{if } 1 < \lambda_z \leq 3 \\ \alpha_z & \text{if } \lambda_z > 3 \end{cases}$
The factor	$\psi_z := \begin{cases} \frac{M_{\text{Ed1z.col.GC}}}{M_{\text{Ed2z.col.GC}}} & \text{if } -1 \leq \frac{M_{\text{Ed1z.col.GC}}}{M_{\text{Ed2z.col.GC}}} \leq 1 \\ \frac{M_{\text{Ed2z.col.GC}}}{M_{\text{Ed1z.col.GC}}} & \text{if } -1 \leq \frac{M_{\text{Ed2z.col.GC}}}{M_{\text{Ed1z.col.GC}}} \leq 1 \end{cases}$
And the equivalent uniform moment factor	$C_{mz} := 0.6 + 0.4\psi_z$

CHECK 2: strong axis bending combined with buckling

$\text{Check}_2 := \left[\frac{N_{\text{Ed.col.GC}}}{N_{\text{uy.col}}} + \frac{1}{1 - \frac{N_{\text{Ed.col.GC}}(\lambda_y \cdot \lambda_y)^2}{N_{\text{uy.col}}}} \cdot C_{my} \frac{M_{\text{Edymax.col}}}{M_{\text{Rdy.redV}}} \cdot K_{My} \right]$	
With:	
The factor	$K_{My} := \begin{cases} 0.9 & \text{if } \lambda_y \leq 1 \\ \left[0.9 + 0.5(\alpha_y - 0.9) \cdot (\lambda_y - 1) \right] & \text{if } 1 < \lambda_y \leq 3 \\ \alpha_y & \text{if } \lambda_y > 3 \end{cases}$
The factor	$\psi_y := \begin{cases} \frac{M_{\text{Ed1y.col.GC}}}{M_{\text{Ed2y.col.GC}}} & \text{if } -1 \leq \frac{M_{\text{Ed1y.col.GC}}}{M_{\text{Ed2y.col.GC}}} \leq 1 \\ \frac{M_{\text{Ed2y.col.GC}}}{M_{\text{Ed1y.col.GC}}} & \text{if } -1 \leq \frac{M_{\text{Ed2y.col.GC}}}{M_{\text{Ed1y.col.GC}}} \leq 1 \end{cases}$
And the equivalent uniform moment factor	$C_{my} := 0.6 + 0.4\psi_y$

CHECK 3: strong axis bending combined with lateral torsional buckling

$\text{Check}_3 := \left[\frac{N_{\text{Ed.col.GC}}}{N_{\text{uz.col}}} + \frac{1}{1 - \frac{N_{\text{Ed.col.GC}}(\lambda_y \cdot \lambda_y)^2}{N_{\text{uz.col}}}} \cdot C_{\text{my}} \cdot \frac{M_{\text{Edymax.col}}}{\lambda_{\text{LT}} M_{\text{Rdy.redV}}} \cdot K_{\text{My}} \right] \quad \text{With:}$	
The factor	$K_{\text{My}} := \begin{cases} 0.9 & \text{if } \lambda_y \leq 1 \\ \left[0.9 + 0.5(\alpha_y - 0.9) \cdot (\lambda_y - 1) \right] & \text{if } 1 < \lambda_y \leq 3 \\ \alpha_z & \text{if } \lambda_y > 3 \end{cases}$
The factor	$\psi_y := \begin{cases} \frac{M_{\text{Ed1y.col.GC}}}{M_{\text{Ed2y.col.GC}}} & \text{if } -1 \leq \frac{M_{\text{Ed1y.col.GC}}}{M_{\text{Ed2y.col.GC}}} \leq 1 \\ \frac{M_{\text{Ed2y.col.GC}}}{M_{\text{Ed1y.col.GC}}} & \text{if } -1 \leq \frac{M_{\text{Ed2y.col.GC}}}{M_{\text{Ed1y.col.GC}}} \leq 1 \end{cases}$
And the equivalent uniform moment factor	$C_{\text{my}} := 0.6 + 0.4\psi_y$

CHECK 4: Biaxial bending

$\text{Check}_4 := \frac{M_{\text{Edymax.col}}}{M_{\text{Rdy.redN}}} \cdot C_{\text{my}} + \frac{M_{\text{Edzmax.col}}}{M_{\text{Rdz.redN}}} \cdot C_{\text{mz}} \quad \text{With:}$	
The factor	$\psi_y := \begin{cases} \frac{M_{\text{Ed1y.col.GC}}}{M_{\text{Ed2y.col.GC}}} & \text{if } -1 \leq \frac{M_{\text{Ed1y.col.GC}}}{M_{\text{Ed2y.col.GC}}} \leq 1 \\ \frac{M_{\text{Ed2y.col.GC}}}{M_{\text{Ed1y.col.GC}}} & \text{if } -1 \leq \frac{M_{\text{Ed2y.col.GC}}}{M_{\text{Ed1y.col.GC}}} \leq 1 \end{cases}$
And the equivalent uniform moment factor	$C_{\text{my}} := 0.6 + 0.4\psi_y$
The factor	$\psi_z := \begin{cases} \frac{M_{\text{Ed1z.col.GC}}}{M_{\text{Ed2z.col.GC}}} & \text{if } -1 \leq \frac{M_{\text{Ed1z.col.GC}}}{M_{\text{Ed2z.col.GC}}} \leq 1 \\ \frac{M_{\text{Ed2z.col.GC}}}{M_{\text{Ed1z.col.GC}}} & \text{if } -1 \leq \frac{M_{\text{Ed2z.col.GC}}}{M_{\text{Ed1z.col.GC}}} \leq 1 \end{cases}$
And the equivalent uniform moment factor	$C_{\text{mz}} := 0.6 + 0.4\psi_z$

Results of these 4 checks for an HE 260 B section:

A successful result corresponds to a value below 1,0.

Check 1: 0,835 Check 2: 0,732 Check 3: 0,835 Check 4: $5,0 \times 10^{-5}$

=> OK

5.21 Beams under gravity loads

5.21.1 ACTION EFFECTS UNDER GRAVITY LOADS COMBINATIONS

Steel profiles IPE 270 in the two directions X and Y are necessary to resist to gravity loads combinations and to limit the deflection of beams.

Beams are checked at mid-span where the applied bending moment is the greatest, and at supports where the bending moment is null and the applied shear is the greatest.

Effective widths and modular ratio [EN 1994-1-1: 2004 cl. 5.4.1.2]

Direction X: effective width at span: $b_{\text{eff},X}^+ = 2 \min\left(\frac{l_Y}{2}, 0.7 \frac{l_X}{8}\right) = 1.225 \text{ m}$

Direction Y: effective width at span: $b_{\text{eff},Y}^+ = 2 \min\left(\frac{l_X}{2}, 0.7 \frac{l_Y}{8}\right) = 1.05 \text{ m}$

These values are divided by 2 at extremities of the building.

Nominal modular ratio: $n = 2 E_a/E_{cm} = 12.7$ [EN 1994-1-1: 2004 cl. 5.4.2.2 (11)]

Evaluation of the inertia of the composite beam

The inertia at mid-span is computed according to the gravity center position, with the assumption that the slab concrete is not cracked. The cracked stiffness is not used as the bending moment is positive everywhere under gravity loads.

Actions values

Maximum values from gravity actions combinations – X-direction	
Bending moment at mid-span	$M_{\text{Edc,beam,X,GC}}^+ = 252.5 \text{ kNm}$
Shear load at support	$V_{\text{Edc,beam,X,GC}} = 153.5 \text{ kN}$
Maximum values from gravity actions combinations – Y-direction	
Bending moment at mid-span	$M_{\text{Edc,beam,Y,GC}}^+ = 217.1 \text{ kNm}$
Shear load at support	$V_{\text{Edc,beam,Y,GC}} = 183.6 \text{ kN}$

5.21.2 BENDING RESISTANCE

The bending resistance is computed by equilibrium, in function of the position of the neutral axis.

Class of cross section (composite beam)

The class of the composite section is according to Eurocode EN 1994 clause 5.5.

Bottom flange in tension: class 1. Top flange is composite and connected to slab: class 1.

Whole web in tension: class 1

$$\text{Classsection} := \begin{cases} \text{"Class 1"} & \text{if } \text{Classflange} = \text{"Class 1"} \vee \text{Classweb} = \text{"Class 1"} \\ \text{"Class 2"} & \text{if } \text{Classflange} = \text{"Class 2"} \vee \text{Classweb} = \text{"Class 2"} \\ \text{"Class 3"} & \text{if } \text{Classflange} = \text{"Class 3"} \vee \text{Classweb} = \text{"Class 3"} \\ \text{"Class 4"} & \text{if } \text{Classflange} = \text{"Class 4"} \vee \text{Classweb} = \text{"Class 4"} \end{cases}$$

Position of the neutral axis

The neutral axis can be in the bottom flange of the steel profile, the web, the upper flange or in the concrete slab.

$$\text{PNApl} := \begin{cases} \text{"in bottom flange"} & \text{if } N_{bf} \geq N_w + N_{tf} + N_c \\ \text{"in web"} & \text{if } N_{bf} + N_w \geq N_{tf} + N_c \wedge N_{bf} < N_w + N_{tf} + N_c \\ \text{"in top flange"} & \text{if } N_a \geq N_c \wedge N_{bf} + N_w < N_{tf} + N_c \\ \text{"in slab under lower reinforcements"} & \text{if } N_a \geq N_{cur} + N_{clur} \wedge N_a < N_c \\ \text{"in slab between reinforcements"} & \text{if } N_a + N_{sl} \geq N_{cur} \wedge N_a + N_{sl} < N_{cur} + N_{clur} \\ \text{"in slab below upper reinforcements"} & \text{otherwise} \end{cases}$$

$$\text{PNApl} = \text{"in slab between reinforcements"}$$

$$z_{pl} := \begin{cases} \frac{N_a + N_c}{2 \cdot b \cdot f_{yd}} & \text{if } \text{PNApl} = \text{"in bottom flange"} \\ \frac{2 \cdot t_f \cdot t_w \cdot f_{yd} + N_w + N_{tf} + N_c - N_{bf}}{2 \cdot t_w \cdot f_{yd}} & \text{if } \text{PNApl} = \text{"in web"} \\ \frac{2 \cdot h \cdot b \cdot f_{yd} + N_c - N_a}{2 \cdot b \cdot f_{yd}} & \text{if } \text{PNApl} = \text{"in top flange"} \\ h + e - \frac{N_a}{b_{effe} \cdot f_{cd}} & \text{if } \text{PNApl} = \text{"in slab under lower reinforcements"} \\ h + e - \frac{N_a + N_{sl}}{b_{effe} \cdot f_{cd}} & \text{if } \text{PNApl} = \text{"in slab between reinforcements"} \\ h + e - \frac{N_a + N_{sl} + N_{su}}{b_{effe} \cdot f_{cd}} & \text{if } \text{PNApl} = \text{"in slab below upper reinforcements"} \end{cases}$$

Plastic Bending Resistances

$$\begin{aligned}
 M_{plRdte} := & \left[\begin{aligned}
 & N_{tf} \cdot \left(h - \frac{t_f}{2} + z_{pl} \right) + N_w \cdot \left(z_{pl} - \frac{h}{2} \right) \dots \text{ if } PNA_{pl} = \text{"in bottom flange"} \\
 & + \frac{z_{pl}^2}{2} \cdot b \cdot f_{yd} + \frac{(z_{pl} - t_f)^2}{2} \cdot b \cdot f_{yd} \dots \\
 & + N_c \cdot \left(h + \frac{e}{2} - z_{pl} \right) \\
 & N_{tf} \cdot \left(h - \frac{t_f}{2} - z_{pl} \right) + \frac{(h - t_f - z_{pl})^2}{2} \cdot t_w \cdot f_{yd} \dots \text{ if } PNA_{pl} = \text{"in web"} \\
 & + \frac{(z_{pl} - t_f)^2}{2} \cdot t_w \cdot f_{yd} + N_{bf} \cdot \left(z_{pl} - \frac{t_f}{2} \right) \dots \\
 & + N_c \cdot \left(h + \frac{e}{2} - z_{pl} \right) \\
 & \frac{(h - z_{pl})^2}{2} \cdot b \cdot f_{yd} + \frac{[(h - z_{pl}) - t_f]^2}{2} \cdot b \cdot f_{yd} \dots \text{ if } PNA_{pl} = \text{"in top flange"} \\
 & + N_w \cdot \left(z_{pl} - \frac{h}{2} \right) + N_{bf} \cdot \left(z_{pl} - \frac{t_f}{2} \right) \dots \\
 & + N_c \cdot \left(h + \frac{e}{2} - z_{pl} \right) \\
 & N_a \cdot \left| z_{pl} - \frac{h}{2} \right| + \frac{(h + e - z_{pl})^2}{2} b_{effte} \cdot f_{cd} \text{ if } PNA_{pl} = \text{"in slab under lower reinforcements"} \\
 & N_a \cdot \left| z_{pl} - \frac{h}{2} \right| + N_{sl} \cdot \left| z_{pl} - (h + c_{lr}) \right| \dots \text{ if } PNA_{pl} = \text{"in slab between reinforcements"} \\
 & + \left[\frac{(h + e - z_{pl})^2}{2} b_{effte} \cdot f_{cd} \right] \\
 & N_a \cdot \left| z_{pl} - \frac{h}{2} \right| + N_{sl} \cdot \left| z_{pl} - (h + c_{lr}) \right| \dots \text{ if } PNA_{pl} = \text{"in slab below upper reinforcements"} \\
 & + N_{su} \cdot \left| z_{pl} - (h + e - c_{ur}) \right| \dots \\
 & + \left[\frac{(h + e - z_{pl})^2}{2} b_{effte} \cdot f_{cd} \right]
 \end{aligned} \right.
 \end{aligned}$$

Resistant bending moment at mid-span in X direction	$M_{Rdc,beam,X}^+ = 483.3 \text{ kNm}$
Resistant bending moment at mid-span in Y direction	$M_{Rdc,beam,Y}^+ = 457 \text{ kNm}$

5.21.3 SHEAR RESISTANCE

The shear resistance of the concrete is neglected and the shear resistance of the composite beam is equal to the steel profile shear resistance:

$$V_{Rd,beam} = V_{Rd,steel\ profile\ beam} = 454\ kN \quad [EN\ 1994-1-1: 2004\ cl.\ 6.2.2.2]$$

5.21.4 OTHER CHECKS

CHECK 1: Bending resistance (mid-span): $M_{Rdc,beam,X/Y}^+ \geq M_{Edc,beam,X/Y,GC}^+$

CHECK 2: Shear resistance (support): $V_{Rd,beam} \geq V_{Edc,beam,X/Y,GC}$

CHECK 3: Deflection (SLS). Deflections due to loading applied to the steel member alone should be calculated in accordance with EN 1993-1-1. The deflection of the composite beam has to be limited, according in directions X and Y: deflection $\leq L_{beam}/300$

In X-direction: deflection = 0.023 m = $l_x/300 = 0.023$ m \Rightarrow OK

In Y-direction: deflection = 0.019 m < $l_y/300 = 0.02$ m \Rightarrow OK

5.22 Effects of torsion

Only accidental torsional effects are taken into account because of the symmetry of the structure:

$e = \pm 0.05 L$ in each direction of the structure [EN 1998-1: 2004 cl. 4.3.2 (1)]

Eurocode 8 clause 4.3.3.2.4 stipulates: "the accidental torsional effects may be accounted for by multiplying the action effects in the individual load resisting elements resulting from the application of 4.3.3.2.3(4) by a factor δ given by:"

$$\delta = 1 + 0.6 \frac{x}{L_e} = 1.3$$

5.23 P-Delta effects [EN 1998-1: 2004 cl. 4.4.2.2 (2) and (3)]

Note that deformations of the building taken into account to compute second order effects are given for the building with bracings, whose the design is detailed in the next chapter.

Second-order effects (P- Δ effects) need not be taken into account if the following condition is fulfilled in all storeys:

$$\theta = \frac{P_{tot} \cdot d_r}{V_{tot} \cdot h} \leq 0.10$$

θ is the interstorey drift sensitivity coefficient;

P_{tot} is the total gravity load at and above the storey considered in the seismic design situation

$$P_1 = P_{tot} \quad P_2 = 4P_{tot}/5 \quad P_3 = 3P_{tot}/5 \quad P_4 = 2P_{tot}/5 \quad P_5 = P_{tot}/5$$

d_r is the design interstorey drift, evaluated as the difference of the average lateral displacements d_s at the top and bottom of the storey under consideration and calculated in accordance with $d_s = q d_e$

$$\begin{aligned} d_{r1} &:= (d_{e1}) \cdot q \\ d_{r2} &:= (d_{e2} + -d_{e1}) \cdot q \\ d_{r3} &:= (d_{e3} + -d_{e2}) \cdot q \\ d_{r4} &:= (d_{e4} + -d_{e3}) \cdot q \\ d_{r5} &:= (d_{e5} + -d_{e4}) \cdot q \end{aligned}$$

d_e is the displacement of a point of the structural system, as determined by a linear analysis based on the design response spectrum in accordance with 3.2.2.5 and with F_i the horizontal force acting on storey i (cl. 4.3.3.2.3). V_{tot} is the total seismic storey shear. h is the interstorey height.

$$V_1 := F_1 + F_2 + F_3 + F_4 + F_5$$

$$V_2 := F_2 + F_3 + F_4 + F_5$$

$$V_3 := F_3 + F_4 + F_5$$

$$V_4 := F_4 + F_5$$

$$V_5 := F_5$$

If $0,1 < \theta \leq 0,2$, the second-order effects may approximately be taken into account by multiplying the relevant seismic action effects by a factor equal to $1/(1 - \theta)$

	In X		In Y	
Horizontal displacement as determined by a linear analysis based on the design response spectrum	$d_{e1X} = 3.9\text{mm}$		$d_{e1Y} = 8.1\text{mm}$	
	$d_{e2X} = 9.7\text{mm}$		$d_{e2Y} = 17.9\text{mm}$	
	$d_{e3X} = 15.8\text{mm}$		$d_{e3Y} = 27.9\text{mm}$	
	$d_{e4X} = 21.8\text{mm}$		$d_{e4Y} = 38.3\text{mm}$	
	$d_{e5X} = 27.2\text{mm}$		$d_{e5Y} = 47.7\text{mm}$	
Interstorey drift sensitivity coefficient and corresponding coefficient $1/(1 - \theta)$ at each storey	$\theta_{1X} = 0.046$	coef $_{1X} = 1$	$\theta_{1Y} = 0.169$	coef $_{1Y} = 1.203$
	$\theta_{2X} = 0.059$	coef $_{2X} = 1$	$\theta_{2Y} = 0.175$	coef $_{2Y} = 1.212$
	$\theta_{3X} = 0.054$	coef $_{3X} = 1$	$\theta_{3Y} = 0.156$	coef $_{3Y} = 1.185$
	$\theta_{4X} = 0.047$	coef $_{4X} = 1$	$\theta_{4Y} = 0.145$	coef $_{4Y} = 1.169$
	$\theta_{5X} = 0.038$	coef $_{5X} = 1$	$\theta_{5Y} = 0.118$	coef $_{5Y} = 1.133$

5.24 Eccentric bracings

5.24.1 DESIGN OF VERTICAL SEISMIC LINKS

Bracings are designed according to the Eurocode 8 clause 6.8 under the seismic combination of loads: $1G + 0.3Q + E$

A vertical seismic link hinged at its connection with the beam is chosen, see Figure 5.24.1.

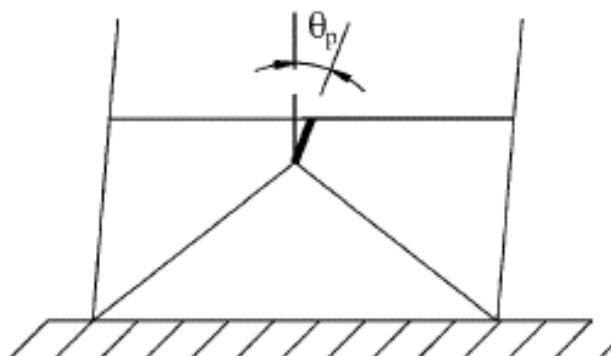

Fig. 5.24.1 Hinged link

Seismic links, which are dissipative elements, are designed before beams, columns and diagonals.

In a design where only one plastic hinge form at one end of the link as in Fig. 5.24.1, the following values of the link length e define the category of the links:

short links: $e < e_{short} = 0,8 M_{p,link}/V_{p,link}$, which dissipate energy by yielding essentially in shear;

long links: $e > e_{long} = 1,5 M_{p,link}/V_{p,link}$, which dissipate energy by yielding essentially in bending;

intermediate links: $e_{short} < e < e_{long}$, which dissipate energy by yielding in shear and bending;

For composite steel-concrete building with composite links (which is not the case studied here), those links should be of short or intermediate length with a maximum length $e = M_{p,link}/V_{p,link}$.

Vertical seismic links properties

Length of the link: $e = 300$ mm; all links are short. Steel sections: as defined in the Table below.

	Steel profile	Link type
1 st storey (ground level)	HE 450 B	short
2 nd storey	HE 450 B	short
3 rd storey	HE 400 B	short
4 th storey	HE 340 B	short
5 th storey	HE 280 B	short

Expression to use to compute the plastic resistance of links	
Bending resistance	$M_{plink} := f_y \cdot b_{plink} \cdot t_{flink} \cdot (h_{plink} - t_{flink})$
Shear resistance	$V_{plink} := \frac{f_y}{\sqrt{3}} \cdot t_{wlink} \cdot (h_{plink} - t_{flink})$
Axial resistance	$N_{plink} := A_{plink} \cdot f_y$

Details of plastic resistances for each storey

$$M_{plink,i} = f_y \cdot b_{plink,i} \cdot t_{flink,i} \cdot (h_{plink,i} - t_{flink,i})$$

$$V_{plink,i} = (f_y / \sqrt{3}) \cdot t_{wlink,i} \cdot (h_{plink,i} - t_{flink,i})$$

$$e_{int} = M_{plink,i} / V_{plink,i}$$

$$e_{short} = 0,8 \cdot M_{plink,i} / V_{plink,i}$$

Storey 1: HE 450 B	$M_{plink,1} = 1141 \text{ kNm}$	$V_{plink,1} = 1182 \text{ kN}$	$e_{int} = 0,96 \text{ m}$	$e_{short} = 0,77 \text{ m}$
Storey 2: HE 450 B	$M_{plink,2} = 1141 \text{ kNm}$	$V_{plink,2} = 1182 \text{ kN}$	$e_{int} = 0,96 \text{ m}$	$e_{short} = 0,77 \text{ m}$
Storey 3: HE 400 B	$M_{plink,3} = 933 \text{ kNm}$	$V_{plink,3} = 1011 \text{ kN}$	$e_{int} = 0,92 \text{ m}$	$e_{short} = 0,74 \text{ m}$
Storey 4: HE 340 B	$M_{plink,4} = 708 \text{ kNm}$	$V_{plink,4} = 761 \text{ kN}$	$e_{int} = 0,93 \text{ m}$	$e_{short} = 0,75 \text{ m}$
Storey 5: HE 280 B	$M_{plink,5} = 455 \text{ kNm}$	$V_{plink,5} = 547 \text{ kN}$	$e_{int} = 0,83 \text{ m}$	$e_{short} = 0,67 \text{ m}$

Actions effects in each seismic link under seismic combination

Action effects are computed using SAP2000 and multiplied by the coefficient $\delta = 1.3$ to take the accidental torsional effect into account. P-Delta effects do not need to be taken into account in this direction X.

Axial loads	Bending moments	Shear loads
$N_{Ed.link1} = 75.4 \text{ kN}$	$M_{Ed.link1} = 285.09 \text{ kN}\cdot\text{m}$	$V_{Ed.link1} = 950.17 \text{ kN}$
$N_{Ed.link2} = 74.62 \text{ kN}$	$M_{Ed.link2} = 296.14 \text{ kN}\cdot\text{m}$	$V_{Ed.link2} = 987.22 \text{ kN}$
$N_{Ed.link3} = 73.19 \text{ kN}$	$M_{Ed.link3} = 247.26 \text{ kN}\cdot\text{m}$	$V_{Ed.link3} = 824.33 \text{ kN}$
$N_{Ed.link4} = 71.76 \text{ kN}$	$M_{Ed.link4} = 195.52 \text{ kN}\cdot\text{m}$	$V_{Ed.link4} = 651.69 \text{ kN}$
$N_{Ed.link5} = 69.94 \text{ kN}$	$M_{Ed.link5} = 121.55 \text{ kN}\cdot\text{m}$	$V_{Ed.link5} = 405.21 \text{ kN}$

Interaction of shear and bending in links with axial force

If $\frac{N_{Ed,link}}{N_{plink}} > 0.15$ the resistant bending moment and the shear resistance have to be reduced, using

Eurocode 8 clause 6.8.2 (5):

$$V_{plinkred} := V_{plink} \left[1 - \left(\frac{N_{Ed,link}}{N_{plink}} \right)^2 \right]^{0.5}$$

$$M_{plinkred} := M_{plink} \left[1 - \left(\frac{N_{Ed,link}}{N_{plink}} \right) \right]$$

Results:

$$N_{Ed,link1}/N_{p,link1} = 0,010$$

$$N_{Ed,link2}/N_{p,link2} = 0,009$$

$$N_{Ed,link3}/N_{p,link3} = 0,011$$

$$N_{Ed,link4}/N_{p,link4} = 0,012$$

$$N_{Ed,link5}/N_{p,link5} = 0,015$$

⇒ No V-N or M-N interaction

Shear - Bending interaction

If $\frac{V_{Ed,link}}{V_{plink}} > 0.5$, the resistant bending moment has to be reduced. [EN 1993-1-1: 2005 cl. 6.2.8]

Check of interaction all conclude in existence of interaction:

$$V_{Ed,link1}/V_{p,link1} = 0,804$$

$$V_{Ed,link2}/V_{p,link2} = 0,835$$

$$V_{Ed,link3}/V_{p,link3} = 0,815$$

$$V_{Ed,link4}/V_{p,link4} = 0,856$$

$$V_{Ed,link5}/V_{p,link5} = 0,739$$

Computation of the resistant bending moments reduced by M-V interaction:

$$M_{plink1} := \begin{cases} M_{plink1} \left[1 - \left(2 \cdot \frac{V_{Ed,link1}}{V_{plink1}} + -1 \right)^2 \right] \\ M_{plink1} \text{ if } 0 \leq \text{Int}_{MV1} \leq 0.5 \end{cases}$$

And similarly at storey 2 to 5. The results obtained are:

$$M_{plink1} = 720 \text{ kNm}$$

$$M_{plink} = 628 \text{ kNm}$$

$$M_{plink} = 562 \text{ kNm}$$

$$M_{plink4} = 349 \text{ kNm}$$

$$M_{plink} = 351 \text{ kNm}$$

CHECK 1: Resistance

$$\frac{N_{Ed,link}}{N_{plink}} \leq 0.15$$

If $\frac{N_{Ed,link}}{N_{plink}}$, the design resistance of the link should satisfy both of the following relationships at both ends of the link (Eurocode 8 clause 6.8.2 (4)):

$$V_{Ed,link} \leq V_{plink} \rightarrow \frac{V_{Ed,link}}{V_{plink}} \leq 1$$

$$M_{Ed,link} \leq M_{plink} \rightarrow \frac{M_{Ed,link}}{M_{plink}} \leq 1$$

$$V_{Ed,link1}/V_{p,link1} = 0,804 \quad V_{Ed,link2}/V_{p,link2} = 0,835 \quad V_{Ed,link3}/V_{p,link3} = 0,815$$

$$V_{Ed,link4}/V_{p,link4} = 0,856 \quad V_{Ed,link5}/V_{p,link5} = 0,739 \quad \Rightarrow \text{OK}$$

$$M_{Ed,link1}/M_{p,link1} = 0,396 \quad M_{Ed,link2}/M_{p,link2} = 0,471 \quad M_{Ed,link3}/M_{p,link3} = 0,440$$

$$M_{Ed,link4}/M_{p,link4} = 0,560 \quad M_{Ed,link5}/M_{p,link5} = 0,346 \quad \Rightarrow \text{OK}$$

CHECK 2: Homogeneity of section overstrength Ω_i over the height of the structure

Ω_i characterise the section overstrength, ratio of the provided plastic resistance of dissipative element to design action effect. To develop a global plastic mechanism in the structure, the values of Ω_i should not be too different over the height of the earthquake resisting structure. For EBF, Ω_i are computed considering a strain hardening factor equal to 1,5:

$$\Omega_{short} = 1.5 \frac{V_{plink}}{V_{Ed,link}} \quad \Omega_{intermediate} = 1.5 \frac{M_{plink}}{M_{Ed,link}}$$

(Eurocode 8 – clause 6.8.3)

$$\Omega_1 = 1,867 \quad \Omega_2 = 1,797 \quad \Omega_3 = 1,840 \quad \Omega_4 = 1,752 \quad \Omega_5 = 2,028$$

To achieve a global dissipative behaviour of the structure, it should be checked that the individual values of the ratios Ω_i do not exceed the minimum value Ω_{min} by more than 25% of this minimum value: $\Omega_{max} \leq 1,25 \Omega_{min}$

$$\Omega_{min} := \min(\Omega_1, \Omega_2, \Omega_3, \Omega_4, \Omega_5) \quad \Omega_{min} = 1.752$$

$$\Omega_{max} := \max(\Omega_1, \Omega_2, \Omega_3, \Omega_4, \Omega_5) \quad \Omega_{max} = 2.028$$

$$\Omega_{max25\%} := 1.25 \Omega_{min} \quad \Omega_{max25\%} = 2.19$$

$$\Omega_{max} \leq 1,25 \Omega_{min} \Rightarrow \text{OK}$$

(Eurocode 8 – clause 6.8.2 (7) or 7.9.3)

5.2.4.2 DESIGN OF DIAGONALS

Minimum resistance requirement

Members not containing seismic links have to be verified in compression considering the most requiring combination of the axial force and bending moments [clause 6.8.3 of Eurocode 8]:

$$N_{Rd} \geq N_{Ed,G} + 1.1 \gamma_{0v} \Omega N_{Ed,E}$$

Where $N_{Ed,G}$ is the force due to the non-seismic actions included in the combination of actions for the seismic design situation

$N_{Ed,E}$ is the force from the analysis due to the design seismic action alone

Ω is the minimum value of multiplicative factors corresponding to seismic links:

$$\Omega_X = 1.752$$

γ_{ov} is the overstrength factor given in Eurocode 8 [EN 1998-1: 2004 cl. 6.2]: $\gamma_{ov} = 1.25$

Maxima axial loads, with the torsional effect taken into account by the coefficient $\delta = 1.3$:

$$N_{Ed,G,diagEB,X} = 47.4 \text{ kN}$$

$$N_{Ed,E,diagEB,X} = 495.2 \text{ kN}$$

$$N_{Ed,diagEB,X} = \left(N_{Ed,G,diagEB,X} + 1.1 \cdot \gamma_{ov} \cdot \Omega_X \cdot N_{Ed,E,diagEB,X} \right) \cdot \delta = 1612 \text{ kN}$$

Resistance of the diagonals to buckling

Diagonals with steel profiles HEB 240 should check the condition:

$$N_{Ed,diagEB,X} \leq \chi \times N_{Rd,diagEB,X}$$

χ is the reduction factor for the relevant buckling curve.

Tensile resistance: $N_{Rd,diagEB,X} = A_{pdiag} \cdot f_y$

The length of buckling is equal to 1 time the length of the diagonal (4,74 m).

Strong axis - Buckling

$$L_{buck.diagEB} := 1 \cdot L_{diagEB}$$

$$N_{cry} := \pi^2 \cdot E_s \cdot \frac{I_{pdiag}}{L_{buck.diagEB}^2}$$

$$L_{buck.diagEB} = 4.74 \text{ m}$$

$$N_{cry} = 1.039 \times 10^7 \text{ N}$$

$$\lambda_y := \sqrt{\frac{N_{Rd.diagEB}}{N_{cry}}}$$

$$\lambda_y = 0.593$$

$$\alpha_y := \begin{cases} 0.206 & \text{if } \frac{h_{pdiag}}{b_{pdiag}} > 1.2 \\ 0.339 & \text{if } \frac{h_{pdiag}}{b_{pdiag}} \leq 1.2 \end{cases}$$

$$\alpha_y = 0.339$$

$$\phi_y := 0.5 \left[1 + \alpha_y \cdot (\lambda_y - 0.2) + \lambda_y^2 \right]$$

$$\phi_y = 0.743$$

$$\chi_y := \frac{1}{\left(\phi_y + \sqrt{\phi_y^2 - \lambda_y^2} \right)}$$

$$\chi_y = 0.841$$

$$N_{uy.diagEB} := \chi_y \cdot N_{Rd.diagEB}$$

$$N_{uy.diagEB} = 3.075 \times 10^3 \text{ kN}$$

Weak axis - Buckling:

$$L_{\text{buck.diagEB}} := 1 \cdot L_{\text{diagEB}}$$

$$N_{\text{crz}} := \pi^2 \cdot E_s \cdot \frac{I_{\text{pdiagz}}}{L_{\text{buck.diagEB}}^2}$$

$$N_{\text{crz}} = 3.619 \times 10^3 \text{ kN}$$

$$\lambda_z := \sqrt{\frac{N_{\text{Rd.diagEB}}}{N_{\text{crz}}}}$$

$$\lambda_z = 1.005$$

$$\alpha_z := \begin{cases} 0.34 & \text{if } \frac{h_{\text{pdiag}}}{b_{\text{pdiag}}} > 1.2 \\ 0.49 & \text{if } \frac{h_{\text{pdiag}}}{b_{\text{pdiag}}} \leq 1.2 \end{cases}$$

$$\alpha_z = 0.49$$

$$\phi_z := 0.5 \left[1 + \alpha_z \cdot (\lambda_z - 0.2) + \lambda_z^2 \right]$$

$$\phi_z = 1.203$$

$$\chi_z := \frac{1}{\left(\phi_z + \sqrt{\phi_z^2 - \lambda_z^2} \right)}$$

$$\chi_z = 0.537$$

$$N_{\text{uz.diagEB}} := \chi_z \cdot N_{\text{Rd.diagEB}}$$

$$N_{\text{uz.diagEB}} = 1.963 \times 10^3 \text{ kN}$$

If $\frac{N_{\text{Ed.diagEB}}}{N_{\text{uz.diagEB}}} \leq 1$ and $\frac{N_{\text{Ed.diagEB}}}{N_{\text{uy.diagEB}}} \leq 1$, then steel profiles HE 240 B are acceptable:

$$\frac{N_{\text{Ed.diagEB}}}{N_{\text{uz.diagEB}}} = 0.821$$

$$\frac{N_{\text{Ed.diagEB}}}{N_{\text{uy.diagEB}}} = 0.524$$

\Rightarrow OK

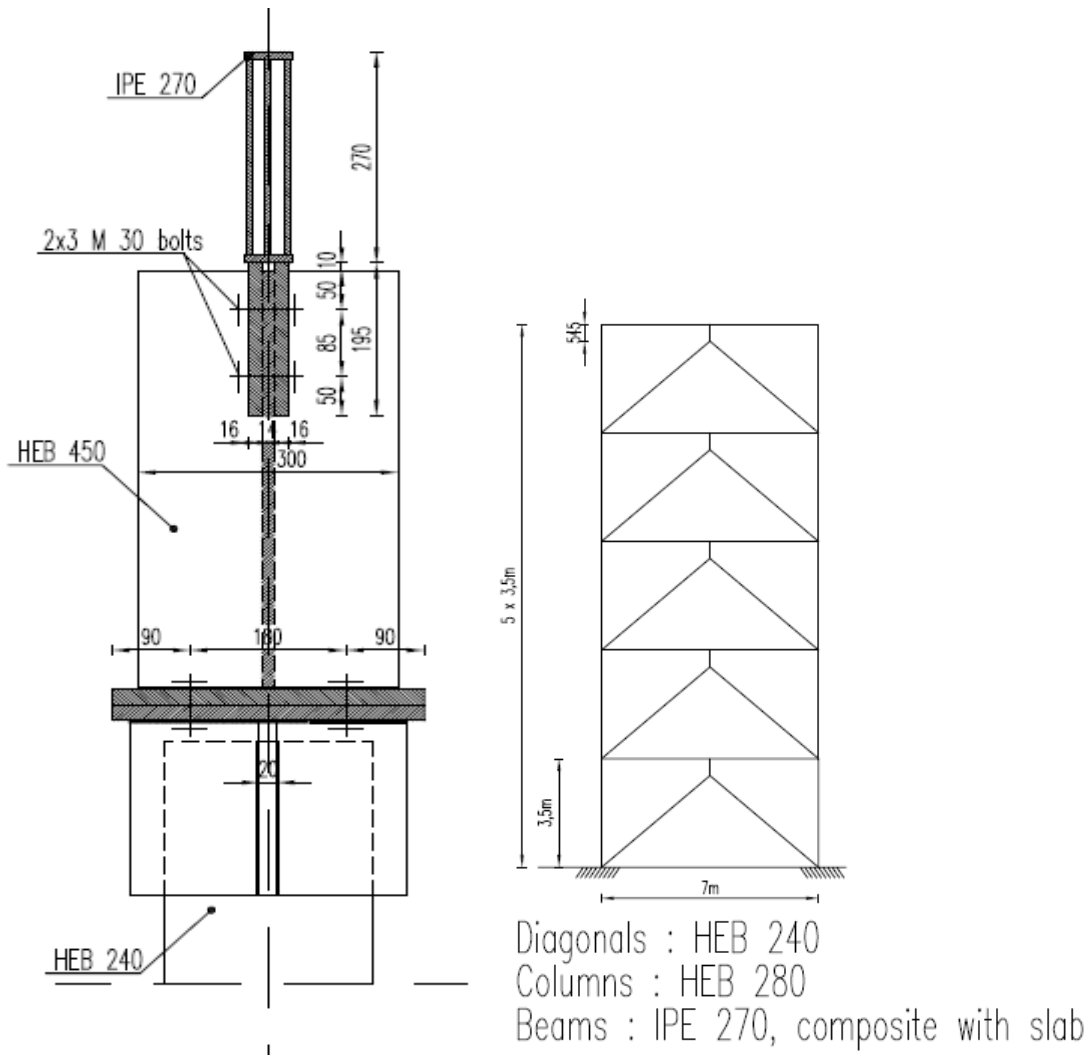

Fig. 5.24.3 Section AA. Elevation view of connection. General view of EBF.

Action effects and plastic resistance of link.

Action effects	Plastic resistance	Section overstrength	
From analysis	With $f_y=355$ MPa	Ω^*	
$V_{Ed}=950$ kN	$V_{pl,Rd} = 1182$ kN	$1182/952 = 1,24$	
$M_{Ed}=285$ kNm	$M_{pl,Rd} = 1141$ kNm		$M_{Ed}/M_{pl,Rd} = 0,25$
$N_{Ed}=75$ kN	$N_{pl,Rd} = 7739$ kN		$N_{Ed}/N_{pl,Rd} = 0,01$

*Section overstrength Ω refers to shear because the link is dissipative in shear.

Connection IPE270 beam – HEB450 link

$$V_{Ed, connection} = 1,1 \gamma_{ov} V_{pl,Rd} = 1,1 \times 1,25 \times 1182 = 1625 \text{ kN}$$

Bolts. $6 \text{ M30 bolts, } 2 \text{ shear planes: } V_{Rd} = 2 \times 6 \times 280,5/1,25 = 2688 \text{ kN} > 1625$

HEB450 web. Thickness $t_w=14$ mm

Bearing resistance with $e_1 = 60$ mm, $e_2 = 50$ mm, $p_1 = p_2 = 85$ mm $V_{Rd} = 2028$ kN > 1625 kN
And 2688 kN > $1,2 \times 2028$ kN = 2433 kN as requested by Eurocode 8 clause 6.5.5 (5).

Gussets welded on IPE270 lower flange.

2 plates $t=16$ mm $\tau=1625 \cdot 10^3 / (2 \times 16 \times 320)=180 < 355/\sqrt{3}=204$ MPa

Total thickness provided = 32 mm > $t_{w,HEB450}=14$ mm => all checks.

IPE270 web stiffeners. $t_w=6,6$ mm is not enough => 2 plates $t=6$ mm welded on IPE270 flanges

Provide total thickness $6,6 + 6 + 6 = 18,6$ mm > $t_{w,HEB450}=14$ mm => all checks.

Connection HEB240 diagonals – HEB450 link

Bolted connection of HEB450 link end plate to welded built up triangle

$V_{Ed, connection} = 1,1 Y_{ov} V_{pl,Rd} = 1,1 \times 1,25 \times 1182 = 1625$ kN

$M_{Ed, connection} = 1,1 Y_{ov} \Omega M_{Ed} = 1,1 \times 1,25 \times 1,24 \times 285 = 485$ kNm

$M_{Ed, connection}$ taken by bolts with lever arm $\approx 450 + 100 = 550$ mm

$\Rightarrow F_{bolts, total} = 485/0,55 = 881$ kN => 2 M30 in tension, each side: $2 \times 504,9 / 1,25 = 808$ kNm
Satisfactory for 881 kNm taking into account excess of resistance of web bolts.

$V_{Ed, connection}$ taken by M30 bolts, single shear plane.

8 M30 bolts provide shear resistance $8 \times 280,5 / 1,25 = 1795$ kN > 1625 kN

Bearing resistance: $8 \times 289,8 \times 1,4 = 3245$ kN > 1625 kN

Welded connection between HEB450 and end plate

As above: $V_{Ed, connection} = 1625$ kN $M_{Ed, connection} = 485$ kNm

$V_{Ed, connection}$ taken by the web. Weld length = $2 \times 400 = 800$ mm

An $a=8$ mm fillet weld provides a resistance: $(8 \times 261,7)/1,25=1674$ kN > 1625 kN

$M_{Ed, connection} = 485$ kNm taken by the flanges. Weld length = $2 \times 300 = 600$ mm/flange

Tension force in flange = $485 / (2 \times 0,2m)=1214$ kN => 202 kN/100 mm

An $a=8$ mm fillet weld provides a resistance: $6 \times 261,7 / 1,25= 1256$ kN > 1214 kN

Connection of HEB240 diagonals to welded built up triangle

$N_{Ed, 1 diagonal} = N_{Ed, gravity} + 1,1 Y_{ov} N_{Ed,E} = 1612$ kN $N_{pl,Rd} = 10600 \times 355 = 3763$ kN

$N_{Ed} / N_{pl,Rd} = 0,43$

$M_{Ed, 1 diagonal} = 0,5 \times$ link moment due to equilibrium of node $\Rightarrow M_{Ed, 1 diagonal} = 285/2 = 143$ kNm

$M_{pl,Rd} = 1053 \cdot 10^3 \times 355 = 373$ kNm

$M_{Ed} / M_{pl,Rd} = 0,38$

The stresses in tension and bending are relatively high. The connection is realized with full penetration butt welds.

5.25 Check of eccentric bracings under gravity load combination

5.25.1 VERTICAL SEISMIC LINKS

Internal actions values in each seismic link under gravity loads combination

P-Delta effects do not need to be taken into account in direction X and the torsional effect is not taken into account for this case.

Compression loads	Bending moments	Shear loads
$M_{Ed,link1} = 104.7 \text{ kN}\cdot\text{m}$	$V_{Ed,link1} = 349 \text{ kN}$	$N_{Ed,link1} = 106.9 \text{ kN}$
$M_{Ed,link2} = 94 \text{ kN}\cdot\text{m}$	$V_{Ed,link2} = 313.6 \text{ kN}$	$N_{Ed,link2} = 105.9 \text{ kN}$
$M_{Ed,link3} = 65.5 \text{ kN}\cdot\text{m}$	$V_{Ed,link3} = 218.3 \text{ kN}$	$N_{Ed,link3} = 103.7 \text{ kN}$
$M_{Ed,link4} = 39.1 \text{ kN}\cdot\text{m}$	$V_{Ed,link4} = 130.4 \text{ kN}$	$N_{Ed,link4} = 101.3 \text{ kN}$
$M_{Ed,link5} = 14.3 \text{ kN}\cdot\text{m}$	$V_{Ed,link5} = 47.7 \text{ kN}$	$N_{Ed,link5} = 110.3 \text{ kN}$

Interaction with axial force

If $\frac{N_{Ed,link}}{N_{plink}} > 0.15$ the resistant bending moment and the shear resistance have to be reduced using

Eurocode 8 clause 6.8.2 (5):

$$V_{plinkred} := V_{plink} \left[1 - \left(\frac{N_{Ed,link}}{N_{plink}} \right)^2 \right]^{0.5}$$

$$M_{plinkred} := M_{plink} \left[1 - \left(\frac{N_{Ed,link}}{N_{plink}} \right) \right]$$

Results:

$$N_{Ed,link1}/N_{p,link1} = 0,014$$

$$N_{Ed,link2}/N_{p,link2} = 0,014$$

$$N_{Ed,link3}/N_{p,link3} = 0,015$$

$$N_{Ed,link4}/N_{p,link4} = 0,017$$

$$N_{Ed,link5}/N_{p,link5} = 0,024$$

⇒ No M – N interaction

Shear - Bending interaction

If $\frac{V_{Ed,link}}{V_{plink}} > 0.5$, the resistant bending moment has to be reduced. [EN1993-1-1: 2005 cl. 6.2.8]

Check of interaction:

$$V_{Ed, link1}/V_{p,link1} = 0,295 \quad V_{Ed, link2}/V_{p,link2} = 0,265 \quad V_{Ed, link3}/V_{p,link3} = 0,216$$

$$V_{Ed, link4}/V_{p,link4} = 0,171 \quad V_{Ed, link5}/V_{p,link5} = 0,87$$

Only $V_{Ed, link5}/V_{p,link5} = 0,87 > 0,5$

Reduced resistant bending moment $M_{plink,5}$:

$$M_{plink5} := \begin{cases} M_{plink5} \left[1 - \left(2 \cdot \frac{V_{Ed,link5}}{V_{plink5}} + -1 \right)^2 \right] & \text{if } Int_{MV5} > 0.5 \\ M_{plink5} & \text{if } Int_{MV5} \leq 0.5 \end{cases} \quad M_{plink5} = 455.56 \text{ kN}\cdot\text{m}$$

Resistance of seismic links

If $\frac{N_{Ed,link}}{N_{plink}} \leq 0.15$, the design resistance of the link should satisfy both of the following relationships at

both ends of the link (Eurocode 8 clause 6.8.2 (4)):

$$V_{Ed,link} \leq V_{plink} \quad \rightarrow \quad \frac{V_{Ed,link}}{V_{plink}} \leq 1$$

$$V_{Ed, link1}/V_{p,link1} = 0,295 \quad V_{Ed, link2}/V_{p,link2} = 0,265 \quad V_{Ed, link3}/V_{p,link3} = 0,216$$

$$V_{Ed, link4}/V_{p,link4} = 0,171 \quad V_{Ed, link5}/V_{p,link5} = 0,087 \quad \Rightarrow \text{OK}$$

$$M_{Ed,link} \leq M_{plink} \quad \rightarrow \quad \frac{M_{Ed,link}}{M_{plink}} \leq 1$$

$$M_{Ed, link1}/M_{p,link1} = 0,092 \quad M_{Ed, link2}/M_{p,link2} = 0,082 \quad M_{Ed, link3}/M_{p,link} = 0,07$$

$$M_{Ed, link4}/M_{p,link4} = 0,055 \quad M_{Ed, link}/M_{p,link5} = 0,031 \quad \Rightarrow \text{OK}$$

5.25.2 CHECK OF RESISTANCES OF DIAGONALS

$$\frac{N_{Ed,diagEB}}{N_{uz,diagEB}} = 0.16$$

$$\frac{N_{Ed,diagEB}}{N_{uy,diagEB}} = 0.102 \quad \Rightarrow \text{OK}$$

5.26 Check of the beam in the direction X under gravity combination of loads

The beam is checked under negative bending moment at mid-span due to the additional support created by the eccentric bracing. Cracked flexural stiffness of the composite beam is considered on 15% of the span on each side of the support; that length correspond to the negative bending moment zone.

$$\text{Effective width at the additional support: } b_{\text{eff},X}^- = \min\left(\frac{I_Y}{2}, 0.25 \frac{I_X/2 + I_X/2}{8}\right) = 0.219 \text{ m}$$

The section is class 3, then an elastic check of the bending resistance is applied:

$$M_{\text{Ed,e.Cbeam.GC}} = 49.05 \text{ kNm}$$

$$M_{\text{Rdel.e.beam}} = 119.45 \text{ kNm}$$

$$\frac{M_{\text{Ed,e.Cbeam.GC}}}{M_{\text{Rdel.e.beam}}} = 0.411 \Rightarrow \text{OK}$$

5.27 Concentric bracings

Concentric bracings are designed according to Eurocode 8, clause 6.7, as being diagonal bracings. Clause 6.7.2 says that, in frames with diagonal bracings, only the tension diagonals shall be taken into account in an elastic analysis of the structure for the seismic action. One assumption is made for buckling checks: the two diagonals are linked together at the middle of their length.

5.27.1 PROPERTIES OF DIAGONAL ELEMENTS

UPE steel profiles are used for diagonals of the bracings.

Storey	Steel profile	A mm ²	N _{Ed,CBi} kN	N _{Rd,CB1} kN	Ω _i	$\bar{\lambda}$
1 st (ground level)	UPE 160	2170	492	770	1,56	1,80
2 nd	UPE 160	2170	531	770	1,45	1,80
3 rd	UPE 180	2510	657	891	1,35	1,70
4 th	UPE 160	2170	531	770	1,45	1,80
5 th	UPE 120	1540	373	546	1,46	2,15

Actions effects at each storey

Actions are established using SAP2000; they are multiplied by the torsion factor $\delta=1.3$ and by coefficients established previously to take into account P-Delta effects. The values are given in the Table above.

5.27.2 EUROCODE 8 CHECKS

Eurocode 8 imposes to check 4 conditions about the resistance, the characteristics of deflection, the homogeneity of multiplicative factors and the slenderness.

CHECK 1: Similar load deflection characteristics

The diagonal elements of bracings shall be placed in such a way that the structure exhibits similar load deflection characteristics at each storey in opposite senses of the same braced direction under load reversals.

To this end, the following rule should be met at every storey:

$$\frac{|A^+ - A^-|}{A^+ + A^-} \leq 0.05$$

where A^+ and A^- are the areas of the horizontal projections of the cross-sections of the tension diagonals (see Fig. 5.27.1), when the horizontal seismic actions have a positive or negative direction respectively (clauses 6.7.1 (2) and (3) of Eurocode 8) \Rightarrow OK because of the 2 same diagonals.

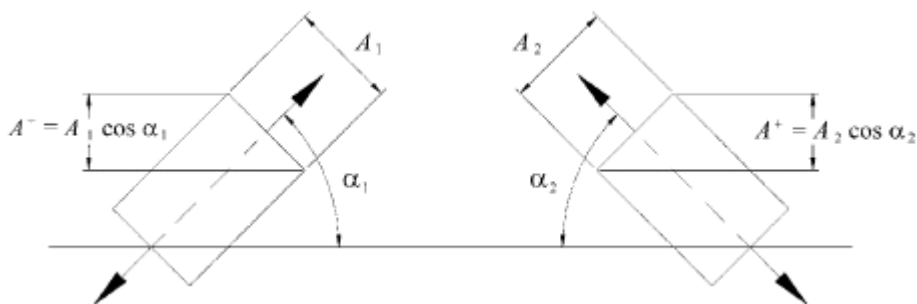

Fig. 5.27.1 Imposed symmetry of bracing system

CHECK 2: Resistance of dissipative elements: the diagonals.

$$N_{Ed} \leq N_{pl}$$

N_{Ed} is the force due to the combination of actions for the seismic design situation.

N_{pl} is the design value of axial resistance of diagonal as from Eurocode 3 [EN 1993-1-1: 2004].

The Table above indicates that it checks.

CHECK 3: Homogeneity of overstrength factor Ω

It should be checked that $\Omega_{\max} \leq 1,25 \Omega_{\min}$ (clause 6.7.3 (8) of Eurocode 8) .

From the Table above: $\Omega_{\max} = 1,56$ $\Omega_{\min} = 1,35$ $\Omega_{\max} = 1,56 < 1,25 \Omega_{\min} = 1,69$

OK

CHECK 4: Limitations of Slenderness

In frames with X diagonal bracings, the non-dimensional slenderness $\bar{\lambda}$ as defined in EN 1993-1-1:2004 should be limited to:

$$1.3 < \lambda \leq 2 \quad (\text{clause 6.7.3 (1) of Eurocode 8})$$

The slenderness is computed according to the weak axis of the steel profile and with a buckling length $L_{\text{buckling,CB}} = 0,9 \times 0,5 L_{\text{CB}}$, with the assumption that the two diagonals are linked together at their middle.

$$\lambda_z = \sqrt{\frac{N_{\text{Rd,CB}}}{N_{\text{crz}}}} \quad \text{with} \quad N_{\text{crz}} = \pi^2 E_a \frac{I_{\text{pzCB}}}{L_{\text{buck.CB}}^2} \quad \text{according to the weak axis of steel profiles.}$$

$$\Lambda_{\text{zCB1}} = 1,80 \quad \Lambda_{\text{zCB2}} = 1,80 \quad \Lambda_{\text{zCB3}} = 1,70 \quad \Lambda_{\text{zCB4}} = 1,80 \quad \Lambda_{\text{zCB5}} = 2,15$$

The value 2,15 is kept following the interpretation that it is acceptable because clause 6.7.3 (4) of Eurocode 8 stipulates "In structures of up to two storeys, no limitation applies to lambda" and we consider that this rule applies to the upper 2 storeys, Check 4 is satisfied.

The four conditions are verified by the defined U steel profiles.

5.28 Check of columns under seismic actions

The columns that have to be checked are the ones directly connected to bracings. Three columns are checked:

one is connected to the eccentric bracing at the ground floor (HE 280 B) – X-direction

one is connected to the eccentric bracing at second floor (HE 260 B) – X-direction

one is connected to the concentric bracing (HE 260 B) – Y-direction

Clauses 6.7.4 and 6.8.3 of Eurocode 8 impose that beams and columns with axial forces should meet the following requirement:

$$N_{\text{Rd}}(M_{\text{Ed}}, V_{\text{Ed}}) \geq N_{\text{Ed,G}} + 1.1 \gamma_{0v} \Omega N_{\text{Ed,E}}$$

$N_{\text{Rd}}(M_{\text{Ed}}, V_{\text{Ed}})$ is the axial design resistance of the column in accordance with EN 1993, taking into account the interaction with the bending moment M_{Ed} and the shear V_{Ed} taken at their design value in the seismic situation

$N_{\text{Ed,G}}$ is the force due to the non-seismic actions included in the combination of actions for the seismic design situation

$N_{\text{Ed,E}}$ is the force from the analysis due to the design seismic action alone

$\gamma_{ov} = 1.25$ is the overstrength factor [EN 1998-1: 2004 cl. 6.2]

$\Omega_x = 1.75$ is the minimum section overstrength factor of eccentric bracings – direction X

$\Omega_y = 1.35$ is the minimum section overstrength factor of concentric bracings – direction Y

P-Delta effects are taken into account in the direction Y, by multiplying internal loads by the following coefficients, according to the related storey:

Coef_{1Y} = 1,20 Coef_{2Y} = 1,21 Coef_{3Y} = 1,18 Coef_{4Y} = 1,17 Coef_{5Y} = 1,13

Checks of column resistance in X-direction – Ground floor – HE 280 B

$$N_{Ede.col.G} = 702.8 \text{ kN}$$

$$N_{Ede.col.E} = 1.079 \times 10^3 \text{ kN}$$

$$V_{Edey.col.SC} = 12 \text{ kN}$$

$$V_{Edez.col.SC} = 11.2 \text{ kN}$$

$$M_{Ede1y.col.SC} = 39.4 \text{ kN}\cdot\text{m}$$

$$M_{Ede2y.col.SC} = 3.8 \text{ kN}\cdot\text{m}$$

$$M_{Ede1z.col.SC} = 33.3 \text{ kN}\cdot\text{m}$$

$$; M_{Ede2z.col.SC} = 6.6 \text{ kN}\cdot\text{m}$$

Checks of N_{Ed}/N_{Rd} :

Check 1: 0,929

Check 2: 0,79

Check 3: 0,884

Check 4: 0,312

=> all results < 1,0 => OK

In the X-direction (eccentric bracings), the steel profile HEB 280 used for columns can resist the seismic design action. Checks of column resistance in X-direction – Second floor – HE 260 B

Action effects:

$$N_{Ede.col.G} = 556 \text{ kN}$$

$$N_{Ede.col.E} = 725.1 \text{ kN}$$

$$V_{Edey.col.SC} = 1 \text{ kN}$$

$$V_{Edez.col.SC} = 2.5 \text{ kN}$$

$$M_{Ede1y.col.SC} = 4.2 \text{ kN}\cdot\text{m}$$

$$M_{Ede2y.col.SC} = 3.4 \text{ kN}\cdot\text{m}$$

$$M_{Ede1z.col.SC} = 5.7 \text{ kN}\cdot\text{m}$$

$$M_{Ede2z.col.SC} = 2.8 \text{ kN}\cdot\text{m}$$

Checks of N_{Ed}/N_{Rd} :

Check 1: 0,682

Check 2: 0,589

Check 3: 0,669

Check 4: 0,045

=> all results < 1,0 => OK

In X-direction (eccentric bracings): the steel profile HEB 260 used for columns can resist the seismic design action at upper floors.

Checks of column resistance Y-direction – HE 260 B

Action effects:

$$N_{Ede.col.G} = 666.8 \text{ kN}$$

$$N_{Ede.col.E} = 898.9 \text{ kN}$$

$$V_{Edey.col.SC} = 9.865 \text{ kN}$$

$$V_{Edez.col.SC} = 10.34 \text{ kN}$$

$$M_{Ede1y.col.SC} = 33.684 \text{ kN}\cdot\text{m}$$

$$M_{Ede2y.col.SC} = 3.368 \text{ kN}\cdot\text{m}$$

$$M_{Ede1z.col.SC} = 30.267 \text{ kN}\cdot\text{m}$$

$$M_{Ede2z.col.SC} = 5.654 \text{ kN}\cdot\text{m}$$

Checks of N_{Ed} / N_{Rd} :

Check 1: 0,824

Check 2: 0,682

Check 3: 0,774

Check 4: 0,244

=> all results < 1,0 => OK

Y-direction (concentric bracings): the steel profile HEB 260 used for columns can resist the seismic design action.

Connection of a CBF diagonal

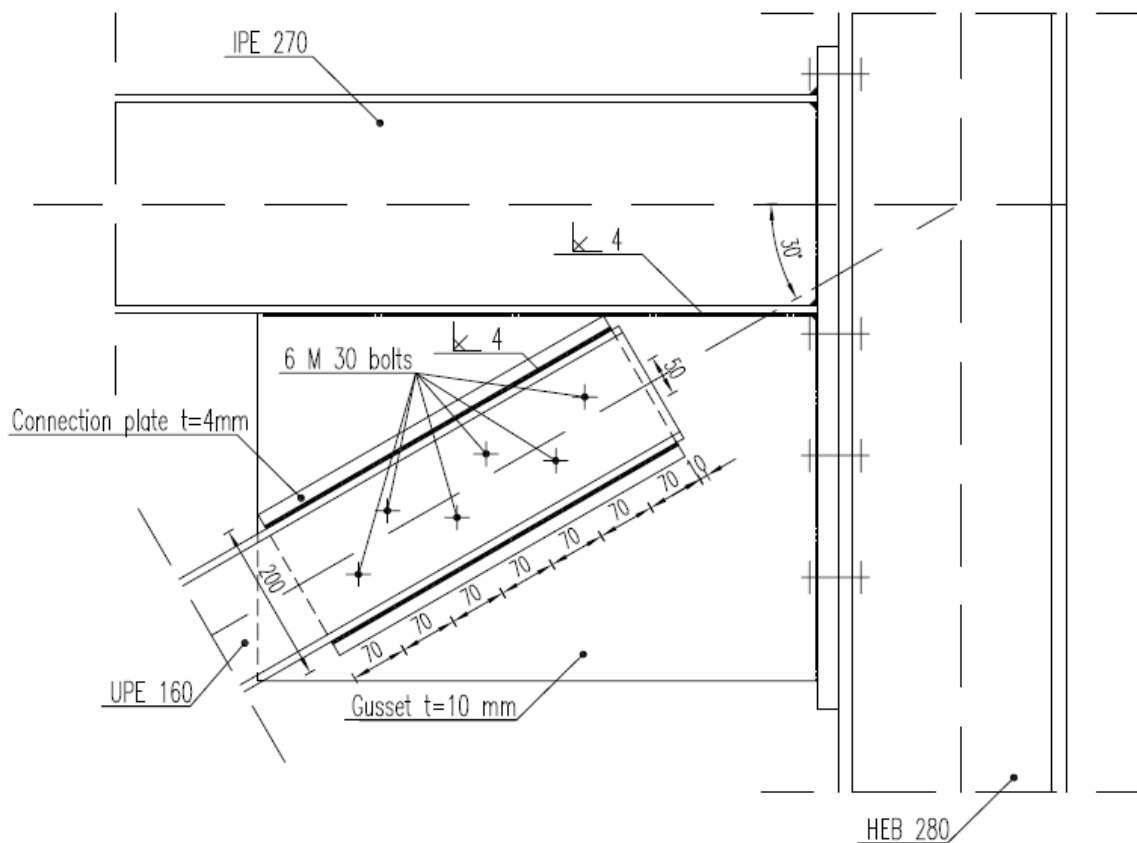

Fig. 5.28.1 View of CBF connection in elevation.

We consider the diagonal at level 1.

From the analysis: $N_{Ed,BC1}=492$ kN

From the design, a section UPE160 is selected: $N_{pl,Rd}=A \times f_{y,d}=2170 \times 355 = 770$ kN

The resistance of the connection is conditioned by a capacity design to the plastic resistance of the UPE160 section. The connection should be such that:

$$N_{Rd,connect} \geq 1,1 \gamma_{ov} N_{pl,Rd} = 1,1 \times 1,25 \times 770 = 1058 \text{ kN}$$

The connection will make use of:

- A plate placed flat and welded onto the web of the U;
- A gusset welded to the column and the beam
- Bolts M30 grade 10.9 passing through holes in the web+plate and in the gusset.

There is not much space for the bolts, as the inner flat part is only 117 mm wide; for M30 bolt, free space around the bolt for nut and is minimum 55,4 mm. Bolts are placed staggered.

6 bolts, resistance in shear, one shear plane, for M30 bolts:

$$F_{V,Rd} = 6 \times 280,5 / 1,25 = 1344 \text{ kN} > 1058 \text{ kN}$$

UPE web thickness = 5,5 mm; additional plate thickness = 4 mm; total: 9,5 mm.

Bearing resistance: $F_{b,Rd} = k_1 \alpha_b f_u d t / \gamma_{M2}$

Here: $\alpha_b \leq 1$ or $\alpha_b = \alpha_d$ as $f_{ub} (1000) > f_u (510 \text{ for S355})$

Values of parameters: $e_1 = 70$ mm $e_2 = 65$ mm $p_2 = 50$ mm

$\alpha_d = 70 / (3 \times 33) = 0,71$ end bolt $\alpha_d = 70 / (3 \times 33) - 0,25 = 0,71 - 0,25 = 0,45$ inner bolt

$k_1 = (2,8 \times 65) / 33 - 1,7 = 3,8 \Rightarrow 2,5$ edge bolt k_1 : no inner bolts

Bearing resistance:

$$4 \times 2,5 \times 0,71 \times 30 \times 510 \times 9,5 / 1,25 + 2 \times 2,5 \times 0,45 \times 510 \times 30 \times 9,5 = 1087 \text{ kN} > 1058 \text{ kN}$$

Additionally, $1344 \text{ kN} > 1,2 \times 1087 = 1304 \text{ kN}$ as requested by Eurocode 8 clause 6.5.5 (5).

Welds of plate placed flat on UPE web: weld throat cannot be more than $t_{plate} \times \sqrt{2} / 2 = 4 \times 0,707 = 3$ mm

Resistance of a 3 mm weld: $(98,1 \text{ kN} : 1,25) / 100 \text{ mm} = 78,5 \text{ kN} / 100 \text{ mm}$

Force to transmit: proportional to plate thickness: $(4 \times 1058) / (4 + 5,5) = 445$ kN

Plate perimeter as from bolted connection: $2 \times (7 \times 70 + 160) = 1300$ mm

\Rightarrow resistance = $13 \times 78,5 = 1020 \text{ kN} > 445 \text{ kN}$

Gusset: 10 mm thick plate (as UPE web thickness + 4 mm plate = 9,5 mm).

Welds: length = $2 \times (7 \times 70 + 160 \times 0,707) = 1206 \text{ mm} \times 2$ (2 sides) = $2412 \text{ mm} = 24 \times 100 \text{ mm}$

With a = 4 mm fillet welds: $(24 \times 130,9) / 1,25 = 2513 \text{ kN} > 1058 \text{ kN}$

5.29 Check of beams under seismic actions

5.29.1 RESISTANCE REQUIREMENT

Clauses 6.7.4 and 6.8.3 of Eurocode 8 impose that beams and columns with axial forces should meet the same requirement:

$$N_{Rd}(M_{Ed}, V_{Ed}) \geq N_{Ed,G} + 1.1\gamma_{0v}\Omega N_{Ed,E}$$

$N_{Rd}(M_{Ed}, V_{Ed})$ is the axial design resistance of the beam in accordance with EN 1993, taking into account the interaction with the bending moment M_{Ed} and the shear V_{Ed} taken at their design value in the seismic situation

$N_{Ed,G}$ is the force due to the non-seismic actions included in the combination of actions for the seismic design situation

$N_{Ed,E}$ is the force from the analysis due to the design seismic action alone

$\gamma_{0v} = 1.25$ is the overstrength factor [EN 1998-1: 2004 cl. 6.2]

$\Omega_X = 1.752$ is the minimum multiplicative factor of eccentric bracings – direction X

$\Omega_Y = 1.158$ is the minimum multiplicative factor of concentric bracings – direction Y

P-Delta effects are taken into account in the direction Y.

Modular ratio for the seismic design: $n = 7$ [EN 1998-1: 2004 cl. 7.4.2]

5.29.2 BEAM CHECKS

At mid-span, the bending resistance is computed taken into account compression loads into the slab and the steel profile:

Compression load into the slab: the software SAP 2000 gives evolution of forces in function of the shell element length. The maximum load is multiplied by the effective width with the assumption that it is not exactly at the support and local effects are neglected. Compression load into the slab is assessed applied at the gravity centre of the slab section.

The compression load into the steel profile is assessed applied at the gravity centre of the section.

Beams are checked under a positive axial force and then under a negative one. Only worst case results are presented hereafter.

The shear load and the bending moment applied to the composite beam are taken equal to the sum of the shear load or the bending moment in the slab and the shear load or the bending moment in the steel beam for the seismic combination of loads.

At supports, where the bending moment is equal to zero, a check of the steel profile alone is done at supports as there is not element of slab, under the compression load and the shear load.

X-direction at mid-span (Negative bending moment at the additional support)

Effective width at the additional support: $b_{eff,X}^- = \min\left(\frac{l_Y}{2}, 0.25\frac{l_X/2 + l_X/2}{8}\right) = 0.219m$

Action effects in the slab:

$$N_{Ede.slab.E} = 147.43 \text{ kN}$$

$$N_{Ede.slab.G} = 3.02 \text{ kN}$$

$$N_{Ede.slab} := N_{Ede.slab.G} + 1.1 \gamma_{0v} \cdot \Omega_x \cdot N_{Ede.slab.E}$$

Action effects in the steel profile of the composite beam:

$$N_{Ede.Sbeam.E} = 201.14 \text{ kN}$$

$$N_{Ede.Sbeam.G} = 4.3 \text{ kN}$$

$$N_{Ede.Sbeam} := N_{Ede.Sbeam.G} + 1.1 \gamma_{0v} \cdot \Omega_x \cdot N_{Ede.Sbeam.E}$$

Shear and bending:

$$V_{Ede.Cbeam.SC} = 109.80 \text{ kN}$$

$$M_{Ede.Cbeam.SC} = 60.72 \text{ kN}\cdot\text{m}$$

Checks – X-direction – Mid-span

$$V_{Rd.beam} = 453.7 \text{ kN}$$

$$\frac{V_{Ede.Cbeam.SC}}{V_{Rd.beam}} = 0.242$$

$$M_{Rdel.e.beam} = 119.45 \text{ kNm}$$

$$\frac{M_{Ede.Cbeam.SC}}{M_{Rdel.e.beam}} = 0.508$$

At supports, action effects in the steel profile:

$$N_{Ede.Sbeam.E} = 230.6 \text{ kN}$$

$$N_{Ede.Sbeam.G} = 18.97 \text{ kN}$$

$$N_{Ede.Sbeam} := N_{Ede.Sbeam.G} + 1.1 \gamma_{0v} \cdot \Omega_x \cdot N_{Ede.Sbeam.E}$$

$$V_{Ede.Sbeam.SC} = 4.7 \text{ kN}$$

Checks – X-direction – Support

$$\frac{N_{Ede.Sbeam.SC}}{N_{Rd.profile}} = 0.352$$

$$\frac{V_{Ede.Sbeam.SC}}{V_{Rd.profile}} = 0.07$$

Y-direction, at mid-span

Action effects in the slab:

$$N_{Ede.slab.E} = 108.57 \text{ kN}$$

$$N_{Ede.slab.G} = 0.63 \text{ kN}$$

$$N_{Ede.slab} := N_{Ede.slab.G} + 1.1 \cdot \gamma_{0v} \cdot \Omega_y \cdot N_{Ede.slab.E}$$

Action effects in the steel profile of the composite beam:

$$N_{Ede.Sbeam.E} = 63.3 \text{ kN}$$

$$N_{Ede.Sbeam.G} = 0.3 \text{ kN}$$

$$N_{Ede.Sbeam} := N_{Ede.Sbeam.G} + 1.1 \cdot \gamma_{0v} \cdot \Omega_y \cdot N_{Ede.Sbeam.E}$$

Bending moment:

$$M_{Ede.Cbeam.SC} = 51.32 \text{ kN}\cdot\text{m}$$

Checks – Y-direction – Mid-span

$$M_{Rde.beam} = 370.46 \text{ kNm}$$

$$\frac{M_{Ede.Cbeam.SC}}{M_{Rde.beam}} = 0.139$$

At supports, action effects in into the steel profile:

$$N_{Ede.Sbeam.E} = 252.9 \text{ kN}$$

$$N_{Ede.Sbeam.G} = 1.04 \text{ kN}$$

$$N_{Ede.Sbeam} := N_{Ede.Sbeam.G} + 1.1 \cdot \gamma_{0v} \cdot \Omega_y \cdot N_{Ede.Sbeam.E}$$

$$V_{Ede.Sbeam.SC} = 4.7 \text{ kN}$$

Checks – Y-direction – Support

$$\frac{N_{Ede.Sbeam.SC}}{N_{Rd.profile}} = 0.297$$
$$\frac{V_{Ede.Sbeam.SC}}{V_{Rd.profile}} = 0.066$$

5.30 Diaphragm

Two Eurocode 8 clauses check that floors are working as diaphragms and that these diaphragms are rigid. The first clause is 5.10 (1): “A solid reinforced concrete slab may be considered to serve as a diaphragm, if it has a thickness of not less than 70 mm and is reinforced in both horizontal directions with at least the minimum reinforcement specified in EN 1992-1-1:2004”.

Check1: $h_{\text{slab}} = 180 \text{ mm} > 70 \text{ mm} \Rightarrow \text{OK}$

The second clause is 4.3.1 (4): "The diaphragm is taken as being rigid, if, when it is modelled with its actual in-plane flexibility, its horizontal displacements nowhere exceed those resulting from the rigid diaphragm assumption by more than 10% of the corresponding absolute horizontal displacements in the seismic design situation."

Following values are obtained with only the wind applied to the structure in each direction.

Check2: X-direction: $\delta_{L_E/2} = 0.0058 \text{ m}$ and $\delta_{L_E} = 0.0058 \text{ m} \Rightarrow \text{OK}$

Y-direction: $\delta_{L_C/2} = 0.0163 \text{ m}$ and $\delta_{L_C} = 0.0163 \text{ m} \Rightarrow \text{OK}$

5.31 Secondary elements

According to the Eurocode 8 clause 4.2.2, the total contribution to lateral stiffness of all secondary seismic members should not exceed 15% of that of all primary seismic members.

Frames are considered as secondary elements if the following condition is respected:

$$\frac{\delta_B}{\delta_{MR}} = \frac{S_{MR}}{S_B + S_{MR}} \leq 15\%$$

Where δ_{MR} is the top displacement of the MR structure (without bracings) submitted to a unit horizontal force

δ_B is the top displacement of the building with bracings submitted to a unit horizontal force

S_{MR} is the stiffness of the MR structure (without bracings)

S_B is the stiffness of the building with bracings

OK in X in and Y direction.

5.32 Summary of data and elements dimensions

GENERAL	
Building number	11
Partner	ULg
Structure type	Office
Number of storeys	5
Material	Composite beam / Steel columns
Structural steel	S355
Concrete strength class	C30/35

LOADING	
Live load	3 kN/m ²
Snow load	1.11 kN/m ²
Wind load	1.4 kN/m ²
Seismic action (PGA)	0.25g
Earthquake specification	Soil B – Elastic response spectrum type 1

GLOBAL GEOMETRY			
X-direction		Y-direction	
Resisting system	Eccentric bracings (vertical seismic link)	Resisting system	Concentric bracings
Span	3 x 7 m	Span	4 x 6 m
Secondary beams	No	Secondary beam	No
Storey-height distribution	3.5 m	Storey-height distribution	3.5 m

DETAILS			
		X-direction	Y-direction
Mass		1745 tons	
Behaviour factor q		4	
Periods		0.827 s	1.454 s
Slab	Type	Reinforced concrete slab	
	h_{slab}	180 mm	
	Concrete cover	20 mm	
	Lower layer of rebars	Welded fabric 10 T10 + 2 T16	Welded fabric 10 T10
	Upper layer of rebars	Welded fabric 10 T10 + 4 T16	Welded fabric 10 T10
Beams	Type	Discontinuous Composite	Discontinuous Composite
	Steel profiles	IPE 270	IPE 270

DETAILS				
		X-direction		Y-direction
Columns	Steel profiles	HEB 260 – Strong axis		HEB 260 – Weak axis
		Except 4 columns HEB 280 at ground storey (external frames / linked to eccentric bracings)		
Bracings	Type of bracings	Eccentric – Vertical seismic link of 300 mm		Concentric – Diagonal bracings
	Elements of bracings	Dissipative elements (seismic links)	Undissipative elements (diagonals)	Dissipative elements (diagonals)
	1 st storey	HE 450 B	HE 240 B	UPE 180
	2 nd storey	HE 450 B		UPE 200
	3 rd storey	HE 400 B		UPE 180
	4 th storey	HE 340 B		UPE 140
	5 th storey	HE 280 B		UPE 100
Bracings overstrength factors		$\Omega_x = 1.752$		$\Omega_y = 1.158$
Assumptions made		/		X-bracings: - There are linked together at their middle - The Eurocode 8 cl. 6.7.3 (4) rule is applied to the 2 upper storeys

CHAPTER 6

Base Isolation. Overview of key concepts

P. Bisch

IOSIS, EGIS group

6.1 Introduction

This chapter deals with isolated buildings designed according to part 1 of Eurocode 8 (section 10).

Firstly, the main features of base isolation are established in order to explain the design principles adopted in Eurocode 8.

Then, the main types of isolating devices used in base isolation are shown and the principles for their design are given.

The main rules for a good arrangement of structures related to the isolation system and the design criteria for the whole building are given in the third section.

In section 4, the methods for the analysis of an isolated building are shown, in particular the simplified methods and their conditions of validity.

To end this chapter, an example is given, with the main features of the design of an isolated building.

6.2 The main principles of base isolation

6.2.1 OBJECTIVES OF BASE ISOLATION AND SCOPE

6.2.1.1 Objectives

The main type of isolation systems used up to now are based on flexibility with respect to the horizontal forces acting on the structure, such as:

- to increase the period of the fundamental mode to obtain a reduced spectral acceleration response,
- to force the fundamental modal shape to a pure translation, so much as possible,
- to make the higher modes response insignificant by concentrating the mass of the structure into the fundamental mode, thereby drastically decreasing the input energy.

6.2.1.2 Isolation systems covered by Eurocode 8

Rules concerning base isolation of buildings are given in section 10 of part 1. It provides general rules for base isolation and specific rules for buildings.

It covers the design of seismically isolated structures in which the isolation system is located below the main mass of the structure, in an interface which is usually – but not necessarily - a horizontal plane, which separates a substructure (the part of the structure located under the isolation system) and a superstructure above. Substructure and superstructure are designed on different bases.

The isolation system covered by this section may consist of linear or non-linear springs and/or dampers. The typical isolating devices used consist in laminated elastomeric pads, made of an alternation of natural or manufactured rubber and steel plates. These types of pads are used in situations other than seismic for bearing bridge decks, but can also be employed for aseismic design purposes. Other types of pads derived from the classical ones and addition of dampers to the isolation system are also examined. However, the section does not cover passive energy dissipation

systems that are not arranged on a single interface, but are distributed over several storeys or levels of the structure.

Nonetheless, the requirements of section 10 are fully developed for full isolation, i. e. with devices remaining in the elastic domain. Other types of aseismic devices are dealt with in part 2 of Eurocode 8 for bridges.

6.2.2 THE CONCEPT OF BASE ISOLATION

6.2.2.1 An introductory example

To illustrate the principles of base isolation in the linear domain, we take for example a simple model of a building consisting of two identical springs and masses in series, in order to get two modes (Figure 6.2.1).

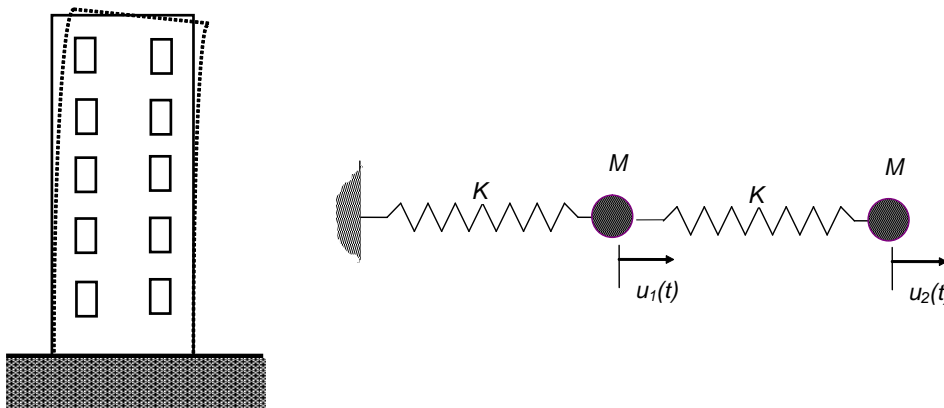

Fig. 6.2.1 Simple model of a building

The modes of such a simple system are easy to obtain analytically and we get the two modes X_1 and X_2 with the corresponding pulsations as follows:

$$X_1 = \begin{bmatrix} 1 \\ \frac{1+\sqrt{5}}{2} \approx 1,618 \end{bmatrix}; \quad X_2 = \begin{bmatrix} 1 \\ \frac{1-\sqrt{5}}{2} \approx -0,618 \end{bmatrix} \quad (6.1)$$

$$\omega_1^2 = \frac{K}{2M}(3-\sqrt{5}) \quad \omega_2^2 = \frac{K}{2M}(3+\sqrt{5})$$

Modal characteristics (periods, participation factors, modal effective masses) are then deduced from these values.

We now interpose a very flexible spring representing the isolation system (Figure 6.2.2), with a stiffness $k \ll K$. The two springs linking the first mass to the foundation may be merged in a single spring with stiffness:

$$\frac{kK}{k+K} = \lambda k = (1-\lambda)K \quad (6.2)$$

Due to the relatively small value of k , λ is close to 1. Introducing $2\alpha = 1 - \lambda$, α is small, which allows for simplifications.

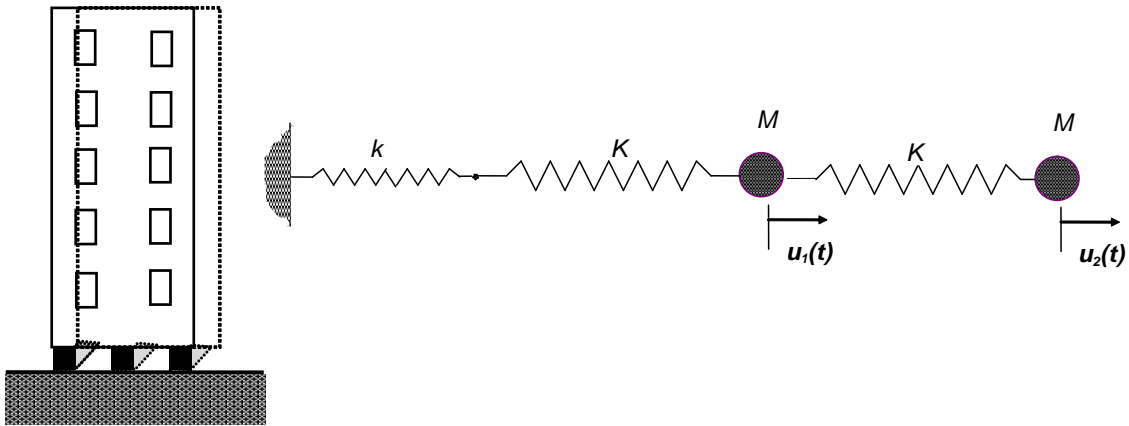

Fig. 6.2.2 Simple model of a building with isolation

The modes of this modified building become:

$$\begin{aligned}
 X'_1 &= \begin{bmatrix} 1 \\ \alpha + \sqrt{1 + \alpha^2} \approx 1 + \alpha \end{bmatrix} & X'_2 &= \begin{bmatrix} 1 \\ \alpha - \sqrt{1 + \alpha^2} \approx -1 + \alpha \end{bmatrix} \\
 \omega_1'^2 &= \frac{1}{2M} \left(2K + \lambda k - \sqrt{4K^2 + \lambda^2 k^2} \right) & \omega_2'^2 &= \frac{1}{2M} \left(2K + \lambda k + \sqrt{4K^2 + \lambda^2 k^2} \right) \\
 &\approx \alpha \left(1 - \frac{\alpha}{2} \right) \frac{K}{M} & &\approx \left[2 + \alpha \left(1 + \frac{\alpha}{2} \right) \right] \frac{K}{M}
 \end{aligned} \tag{6.3}$$

To visualise the effect of the isolation, let us consider reasonable values of the properties: the stiffness of the springs is taken as $K = 1\,650\text{ MN}$ and the masses as $M = 1\,000\text{ T}$ each and the stiffness of the isolation system is taken as 35 MN , then $\lambda = 0,979$ and $\alpha \approx 0,01$.

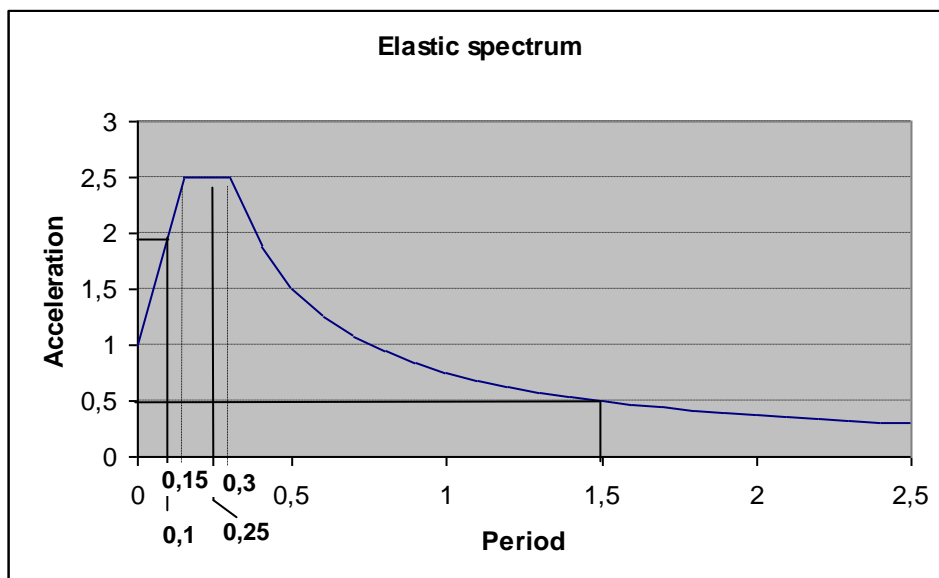

Fig. 6.2.3 Elastic spectrum used for the example

To allow for a complete comparison, an elastic spectrum is given in Figure 6.2.3. Variation of damping is not considered.

In Table 6.2.1, a comparison of main modal characteristics and responses is given. The different modal responses are shown on Figure 6.2.3. Combined values are calculated according to the SRSS method.

Table 6.2.1 Comparison without / with base isolation

Modal characteristics	Non isolated building		Isolated building	
	First mode	Second mode	First mode	Second mode
Period s	0,25	0,096	1,522	0,109
Mode	$X_1 = \begin{bmatrix} 1 \\ 1,618 \end{bmatrix}$	$X_2 = \begin{bmatrix} 1 \\ -0,618 \end{bmatrix}$	$X'_1 = \begin{bmatrix} 1 \\ X'_{1,2} = 1,01 \end{bmatrix}$	$X'_2 = \begin{bmatrix} 1 \\ X'_{2,2} = -0,99 \end{bmatrix}$
Spectral acceleration m/s^2	2,5	1,96	1,5	2,09
Percentage of mass %	$\rho_1 = 94,7$	$\rho_2 = 5,3$	$\rho'_1 \approx 100$	$\rho'_2 \approx 0$
Equivalent static forces kN	$\begin{pmatrix} 1810 \\ 2\,929 \end{pmatrix}$	$\begin{pmatrix} 541 \\ -334 \end{pmatrix}$	$\begin{pmatrix} 500 \\ 500 \end{pmatrix}$	$\approx \begin{pmatrix} 0 \\ 0 \end{pmatrix}$
Displacement mm	$\begin{pmatrix} 2,87 \\ 4,64 \end{pmatrix}$	$\begin{pmatrix} 0,13 \\ -0,08 \end{pmatrix}$	$\begin{pmatrix} 29,2 \\ 29,2 \end{pmatrix}$	$\approx \begin{pmatrix} 0 \\ 0 \end{pmatrix}$
Force in first spring (base) kN	4 744		1 000	
Force in second spring (top) kN	2 948		500	

The following observations can be made from this example:

- The fundamental period has drastically increased from 0,25 s to 1,52 s, thereby decreasing the spectral acceleration of mode 1 from 2,5 m/s^2 to 0,5 m/s^2 . This is the first objective.
- In a plane, the behaviour of the building is that of a quasi-rigid body in translation above the isolation system. This is the second objective.
- The effects of the second mode (accelerations and displacements) are negligible. This is the third objective.
- In return of the decrease of response in terms of accelerations and forces, the displacements are widely increased.

6.2.2.2 Effectiveness of base isolation in the elastic domain

Using the above example, we try now to highlight the main parameters which control the isolation phenomenon. First, we introduce the two reference periods:

- The period of the superstructure is considered as rigid and lying on the isolation system:

$$T_a = 2\pi\sqrt{\frac{2M}{k}} \quad (6.4)$$

- A period T_f represents or is representative of a building without isolation, usually that of the first mode with a fixed base. In the above example, it can be taken as $2\pi\sqrt{M/K}$ or to the first period given by eqn. (6.1).

Then the ratio $\beta = T_a / T_f$ is formed from these two definitions and, in the frame of the example, we have the following relations that we assume would be appropriate in a more general case:

$$\frac{1}{\lambda} = \frac{2}{\beta^2} + 1; \quad \alpha = \frac{1}{2 + \beta^2} \quad (6.5)$$

Usually, β is large, but this point will be discussed below. The following results can be easily demonstrated:

$$\begin{aligned} \left(\frac{T_a}{T'_1}\right)^2 &= \frac{\beta^2}{2 + \beta^2} \left(3 + \beta^2 - \sqrt{5 + 4\beta^2 + \beta^4}\right) \xrightarrow{\beta \rightarrow \infty} 1 \\ \left(\frac{T_f}{T'_2}\right)^2 &= \frac{1}{2 + \beta^2} \left(3 + \beta^2 + \sqrt{5 + 4\beta^2 + \beta^4}\right) \xrightarrow{\beta \rightarrow \infty} 2 \\ X_1'^2 &= \frac{1}{2 + \beta^2} \left(1 + \sqrt{5 + 4\beta^2 + \beta^4}\right) \xrightarrow{\beta \rightarrow \infty} 1 \\ X_2'^2 &= \frac{1}{2 + \beta^2} \left(1 - \sqrt{5 + 4\beta^2 + \beta^4}\right) \xrightarrow{\beta \rightarrow \infty} -1 \\ \rho'_1 &\xrightarrow{\beta \rightarrow \infty} 1; \quad \rho'_2 \xrightarrow{\beta \rightarrow \infty} 0 \end{aligned} \quad (6.6)$$

Where $X_i'^2$ is the second component of mode X_i .

It can be concluded from these limits that when β is significantly greater than 1, then the period of the first mode is slightly greater than T_a and this mode concentrates all the mass of the superstructure. The displacement according to the first mode is determined by the deformation of the isolation system and the structure itself remains quasi-rigid.

The stiffness of the isolation system is chosen so as to obtain a fairly large value of T_a , then of T'_1 , say 1 or 2 s or more, to favour a reduced acceleration response. In this case, the value of T'_1 is found in the range of periods where the pseudo-velocity S_v is constant on a normalised spectrum (in the example considered, the value of S_v is 0,12 m/s). Then the displacement is approximately determined by:

$$u_{\max} \approx \frac{1}{2\pi} S_v T_a \quad (6.7)$$

The relative displacement between both masses in the first mode is given by:

$$\delta_r \approx \frac{1}{2\pi} S_v T'_1 (X_1'^2 - 1) \quad (6.8)$$

In order to judge the effectiveness of the isolation system, values of the main characteristics of the response according to β are given in Table 6.2.2, S_v being equal to 0,12 m/s (this choice influences the values, but has no effect on the tendencies and conclusions that can be drawn).

Table 6.2.2 Variation of response characteristics vs. β

β	$\frac{T_a}{T_1'}$	$\frac{T_f}{T_2'}$	$X_1'^2$	ρ_1'	$2\pi \frac{\delta_r}{S_v T_a}$
1	0,528	1,545	1,387	0,816	0,733
1,5	0,684	1,504	1,263	0,872	0,384
2	0,782	1,477	1,180	0,911	0,231
2,5	0,844	1,459	1,129	0,936	0,152
3	0,884	1,447	1,095	0,953	0,108
4	0,930	1,434	1,057	0,971	0,061
5	0,953	1,427	1,038	0,981	0,040
7	0,975	1,421	1,020	0,990	0,020
10	0,988	1,418	1,010	0,995	0,010
∞	1	1,414	1	1	0

In the example, the value of β is about 10, but it can be seen from Table 6.2.2 that for a value of β which is sufficiently greater than 1, say 3, parameters have values close to their asymptotic values. In this case, the objectives stated at the beginning are met, i. e.:

- a value of the fundamental period, directly linked to the isolation system flexibility, located in the range of periods where the spectral acceleration is low;
- a very preponderant fundamental mode response, where the deformation is concentrated in the pads;
- the second period rapidly reaches the order of $T_f / \sqrt{2}$.

On the contrary, it can be seen that for low values of β , δ_r increases rapidly and the efficiency of the system deteriorates. It is obvious that if the period T_f of the structure is large enough without isolation, there is little interest in isolating it. These findings can be summarised as follows:

- β is the controlling parameter of the isolation system;
- the objectives of the isolation system are met for sufficiently large values of β ;
- base isolation is more effective for rather rigid structures;
- on the contrary, there is little interest in isolating flexible structures.

These conclusions remain valid for more complex structures and a rather stiff soil. When this is not the case, there is a coupling at the base between the translational movement and the rotational one. In this case, a complete modal analysis should be performed.

The findings of the analysis above are widely used in the development of analytical methods in Eurocode 8.

6.2.2.3 Behaviour in the post elastic domain

As in Eurocode 8 design concept is based on energy dissipation, it is necessary to investigate what amount of ductility may be demanded in isolated structures. More precisely, which value can be given to the behaviour factor and is it related to that of the superstructure if it were not isolated? It should be first highlighted that the dynamic response of the superstructure fully depends on the constitutive law of the isolators, so a general answer to the question is doubtful.

However, the post elastic behaviour of an isolated structure may be simply illustrated in the case of linear isolators (springs) with the two masses model shown on Figure 6.2.4, with notations similar to those of Figure 6.2.2.

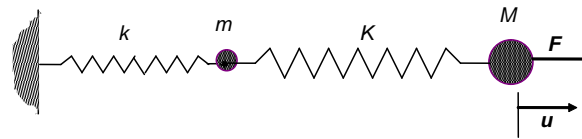

Fig. 6.2.4 Simple two masses model for post elastic assessment

The procedure used is comparable to a push-over: a force is applied to the second mass and the total displacement u is plotted vs. F . It is assumed that the same demand (in terms of u) applies when the structure yields. Two different behaviours are shown on Figure 6.2.5:

- a linear behaviour of both springs (in dashed lines). The total displacement appears as the sum of the displacements due to both springs in the linear domain and the structure reaches point ρ ;
- a linear behaviour of the isolator, which is generally required, and an elastic-plastic behaviour of the structure, which reaches point ρ . The force being limited to F/q , where q is the behaviour factor of the structure, u_{pl} is the plastic demand in the structure.

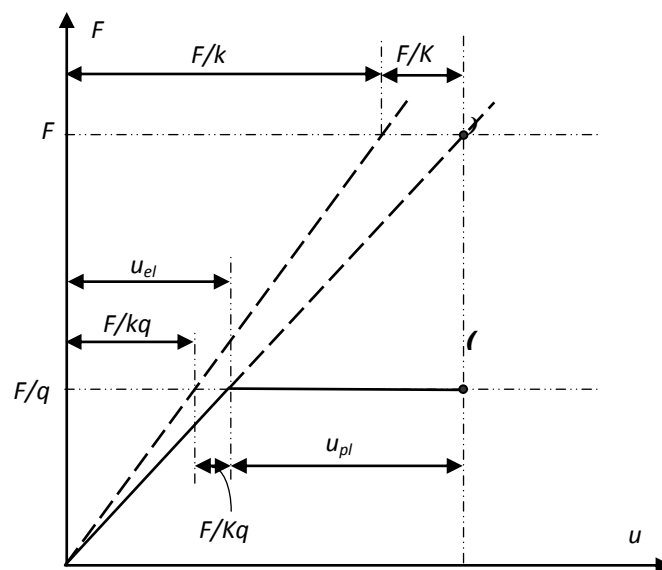

Fig. 6.2.5 Comparison of linear and non linear behaviours

From equality of displacements

$$\frac{F}{k} + \frac{F}{K} = \frac{F}{kq} + \frac{F}{Kq} + u_{pl} \quad (6.9)$$

yields the value of ductility demand in the structure:

$$\mu = \frac{u_{pl}}{\frac{F}{Kq}} = \frac{\frac{F}{k} + \frac{F}{K} - \left(\frac{F}{kq} + \frac{F}{Kq} \right)}{\frac{F}{Kq}} = (q-1) \left[1 + \left(\frac{T_a}{T_r} \right)^2 \right] = (q-1) [1 + \beta^2] \quad (6.10)$$

Even for rather low values of β , f. i. 3, the ductility demand is high: $\mu = 10$ for $q = 2$ and $\mu = 20$ for $q = 3$. But values of β between 5 and 10 are more usual, and it can be seen that the ductility demand may be very high. Therefore, a behaviour factor similar to that of the structure when it is not isolated cannot be applied. This is why the choice of a very limited behaviour factor in Eurocode 8 has been made. Of course, where the substructure is concerned, the situation is different.

The result would be different if the isolators were to yield: in that case, the energy dissipation would take place at this level and the behaviour factor applicable to the structure would depend only on the plastic behaviour of the isolators. A non linear analysis is necessary to assess reasonable values of q in that case.

6.3 The isolating devices and their design

6.3.1 TYPES OF ISOLATION SYSTEMS CONSIDERED

The devices considered in section 10 of part 1 consist of laminated elastomeric bearings, elastic-plastic devices, viscous or friction dampers, pendulums, and other devices whose behaviour achieves the objectives. Each unit provides a single or a combination of the following functions:

- vertical-load carrying capability combined with increased lateral flexibility and high vertical rigidity;
- energy dissipation, either hysteretic or viscous;
- recentering capability; however, as only linear devices are fully addressed in section 10, no requirement is associated to this function which is fulfilled for this type of isolators; indications are given in part 2 in a more general situation;
- lateral restraint (sufficient elastic rigidity) under non-seismic service lateral loads.

The more widely used type of devices employed for isolation consist in laminated elastomeric pads. They are rather flexible in the horizontal directions and stiff perpendicularly to the metal sheets. The rubber sheets may be made of natural rubber or artificial elastomer.

Due to the presence of steel plates, they have a high bearing capacity, of about 10 MPa in service conditions. Their ultimate shear strain is roughly 500%.

The shear modulus is variable with strain; it is about 1 MPa with a damping ratio of 7% in seismic conditions. The mechanical properties of the elastomer may be adjusted with its chemical composition. Also, fillers may be added in natural rubber in order to increase the damping ratio to 20%. Lead cores may also be used to increase the damping by 30%.

Ageing and temperature may affect the properties of rubber. In particular, the shear modulus may increase up to 30% over a period of a 100 years. The design of the pads aims in particular at obtaining low degradability with time and reliability of properties.

The height of elastomeric pads, which governs the fundamental period, is usually limited by its buckling.

Other types of spring-like devices exist, such as f. i.:

- helical steel springs, which have similar axial and transverse stiffness, which induce rotational movements of the superstructure due to the axial flexibility;
- air springs,
- devices using the pendulum effect.

Dampers may be added in parallel to the spring-like devices, to increase the damping ratio of the isolation system such as:

- oleo dynamic devices using oil or high molecular weight polymers,
- steel dampers using the yielding of steel bars,
- devices using dry friction; they are usually in the form of friction plates in series with an elastomeric pad or a pendulum.

It should be mentioned that for high values of damping (> 15%), linear analyses are not convenient and non linear analyses should be performed.

6.3.2 RELIABILITY

Increased reliability is required for the isolating devices, as the behaviour of the superstructure as a whole relies on the isolation system.

This is carried out by applying a magnification factor γ_x on seismic displacements for the design of each unit. For buildings, the recommended value of γ_x is 1,2.

6.3.3 EN 15129

Eurocode 8 deals with the design of the complete isolated building. The design of the devices (and their connection to the structure) used for isolation is covered by the European norm EN 15129. This standard (Anti-seismic devices) specifies functional requirements and general design rules for the seismic situation, material characteristics, manufacturing and testing requirements, as well as evaluation of conformity, installation and maintenance requirements. The titles of the sections are:

- 1. Scope
- 2. Normative references
- 3. Terms, definitions, symbols and abbreviations
- 4. General design rules
- 5. Rigid connection devices
- 6. Displacement Dependent Devices
- 7. Velocity Dependent Devices
- 8. Isolators
- 9. Combinations of Devices
- 10. Evaluation of conformity
- 11. Installation
- 12. In-service inspection

For the sake of designing an isolated building to EN1998-1, sections 4, 8 and partly 9 of EN15129 are useful. It should be mentioned that for the design of laminated pads in situations other than seismic, the European standard EN1337-3 is applicable.

6.3.4 SOME ASPECTS OF THE DESIGN OF DEVICES

An isolator is a device possessing the characteristics needed for seismic isolation:

- ability to support the gravity load of the superstructure,
- ability to accommodate lateral displacements,
- ability to provide energy dissipation; this may be achieved in adding dampers;
- ability to contribute to the isolation system's recentering capability. The purpose of the re-centering capability requirement is not so much that of limiting residual displacement at the end of a seismic event, but instead that of preventing cumulative displacements during the event. A re-centering assumes particular relevance in structures located in close proximity to a fault, where earthquakes characterised by highly asymmetric time histories are expected.

Devices should function according to the design requirements and tolerances throughout their projected service life, given the mechanical, physical, chemical, biological and environmental conditions expected. They should be constructed and installed in such a way that their routine inspection and replacement are possible during the service life of the construction.

Isolators and their connections to the structure should be designed to the limit states defined in Eurocode 8:

- a) to withstand the seismic action effects defined at ULS without local or global failure, thus retaining a residual mechanical resistance, including a residual load bearing capacity after the seismic event: they must accommodate the translation and rotation movements imposed by seismic and other actions whilst supporting the vertical load imposed by gravity and other live loads;
- b) to withstand the seismic action defined at Limit State of Limitation of Damage without the occurrence of damage and the associated limitations of use, the costs of which would be disproportionately high in comparison with the costs of the structure itself.

Design action effects on anti-seismic devices and their connections are assessed on the basis of the design seismic action deduced from the structural seismic analysis. Then the reliability factor γ_x (section 6.3.2) is applied on the action effect considered for the design of the devices.

Capacity design is applied to the connections: an over-strength factor γ_{rel} equal to 1,1 is applied to the actions transmitted by the device to the connections.

Materials used in the design and construction of the devices and their connections to the structure must be in conformity with European Standards.

Material and device properties:

- are assessed so as to represent their behaviour adequately under the conditions of strain and strain rate which can be attained during the design seismic situation;
- take into account the environmental (physical, biological, chemical and nuclear) conditions with which devices can be faced over their service life; in particular, the effects of temperature variation are taken into account;
- take into account the ageing phenomena that can occur during the service life of the device ;
- are represented by representative values, as defined below.

Three sets of design properties of the system of devices are defined:

- a) Design (mean) properties (DP).
- b) Upper bound design properties (UBDP); they correspond to the maximum representative value in the conditions where upper values of properties are obtained.
- c) Lower bound design properties (LBDP); they correspond to the minimum representative value in the conditions where lower values of properties are obtained.

Properties are obtained by considering the quasi permanent values of the variable actions, except for temperature for which the frequent value is taken into account. They are obtained from testing procedures defined in EN15129.

6.4 General arrangement and design criteria

6.4.1 GENERAL ARRANGEMENT

Some design measures are necessary to ensure a good behaviour of the isolation system and of the structure as a whole.

6.4.1.1 Control of displacements relative to surrounding ground and constructions

It has been demonstrated in section 6.2.2 that the decrease of acceleration in the structure is at the price of increased displacements. As they are a consequence of the required flexibility of the isolation system, these displacements should not be prevented; therefore no restraint due to networks, footpath or any other link can be accepted.

Consequently, sufficient space between the superstructure and the surrounding ground and structures should be provided to allow free displacements of the superstructure. This space has also the function of allowing inspection, maintenance and replacement of the devices during the lifetime of the structure, as a possible unacceptable ageing level of the devices could occur.

6.4.1.2 Control of undesirable movements

Control of the torsional movements is provided by the following provisions:

- The effective stiffness centre and the centre of damping of the isolation system should be as close as possible to the projection of the centre of mass on the isolation interface.
- To minimise different behaviour of isolating devices, the compressive stress induced in them by the permanent actions should be as uniform as possible.
- Devices are fixed to the superstructure and the substructure (the case of sliding plates is excluded from this requirement).
- The isolation system is designed so that shocks and potential torsional movements are controlled by appropriate measures. To achieve that goal, appropriate devices (e.g. dampers, shock-absorbers, etc.) may be provided.

6.4.1.3 Control of differential seismic ground motions

For a good efficiency of the isolation system, differential seismic displacements between devices should be avoided. Therefore, structural elements located above and below the isolation interface should be sufficiently rigid in both horizontal and vertical directions,

To attain that goal, a rigid diaphragm is provided above and under the isolation system, consisting of a reinforced concrete slab or a grid of tie-beams, designed taking into account all relevant local and global modes of buckling. This rigid diaphragm is not necessary if the structures consist of rigid boxed structures.

The devices which make up the isolation system are fixed at both ends to the rigid diaphragms defined above, either directly or, if not practicable, by means of vertical elements, the relative horizontal displacement which in the seismic design situation should be lower than 1/20 of the relative displacement of the isolation system.

6.4.2 DESIGN CRITERIA

6.4.2.1 General

The fundamental requirements stated in other sections of Eurocode 8 part 1 for the type of structure considered should be complied with. Additional requirements should also be considered, as given below.

The substructure is verified under the inertia forces directly applied to it and the forces and moments transmitted to it by the isolation system, the superstructure and the isolation system being in the linear elastic domain ($q = 1$).

6.4.2.2 Ultimate limit state

At the Ultimate limit state, gas lines and other hazardous lifelines crossing the joints separating the superstructure from the surrounding ground or constructions are designed to safely accommodate the relative displacement between the isolated superstructure and the surrounding ground or constructions.

In buildings, the structural elements of the substructure and the superstructure may be designed as non-dissipative. Consequently, capacity design and global or local ductility conditions do not need to be satisfied. Nevertheless, it is acceptable to satisfy the resistance condition of the structural elements of the superstructure taking into account seismic action effects divided by a behaviour factor not greater than 1,5.

6.4.2.3 Damage limitation state

At the damage limitation state, all lifelines crossing the joints around the isolated structure should remain within the elastic range.

6.5 Analysis

6.5.1 MODELLING

Modelling of the isolation system should reflect the spatial distribution of the isolator units, so that the translation in horizontal directions, the overturning effects and the rotation about the vertical axis are adequately represented. It should reflect adequately the properties of the different types of devices used in the isolation system.

Values of physical and mechanical properties of the isolation system to be used in the analysis should be the most unfavourable ones to be attained during the lifetime of the structure:

- a) accelerations and inertia forces are evaluated taking into account the maximum value of the stiffness and the minimum value of the damping and friction coefficients;
- b) displacements are evaluated taking into account the minimum value of stiffness and damping and friction coefficients.

They shall reflect the influence of:

- rate of loading;
- magnitude of the simultaneous vertical load;
- magnitude of simultaneous horizontal load in the transverse direction;
- temperature;
- change of properties over projected service life.

6.5.2 SEISMIC ACTION

The two horizontal and the vertical components of the seismic action are assumed to act simultaneously. Therefore, the complete combination of seismic components should be used.

In buildings of importance class IV, site-specific spectra including near source effects should also be taken into account, if the building is located at a distance less than 15 km from the nearest potentially active fault with a magnitude $M_s \geq 6,5$.

6.5.3 EQUIVALENT LINEAR ANALYSIS

An equivalent linear model of the isolation system for analysis is defined by the effective stiffness K_{eff} and the effective damping ξ_{eff} . The effective stiffness is obtained as the sum of the effective stiffness of the devices (i.e. the secant value of the stiffness at the total design displacement of the device d_{db}). The effective damping represents the energy dissipation of the isolation system.

In most cases, the isolation system may be modelled with equivalent linear viscous-elastic behaviour, with the conditions below:

- the effective stiffness of the isolation system is at least 50% of the effective stiffness at a displacement of $0,2d_{dc}$, where d_{dc} is the design displacement of the effective stiffness centre in the direction considered;
- the effective damping of the isolation system does not exceed 30%; however, it is recommended to limit this ratio to 15%;

- the force-displacement characteristics of the isolation system does not vary by more than 10% due to the rate of loading or due to the vertical loads;
- the increase of the restoring force in the isolation system for displacements between $0,5d_{dc}$ and d_{dc} is at least 2,5% of the total gravity load above the isolation system.

For this type of analysis, the value of the behaviour factor is taken as being equal to $q = 1$, the elastic spectrum is used, with a damping correction.

6.5.4 TYPES OF ANALYSIS

6.5.4.1 General

For the equivalent linear analysis, the types of analysis below are considered:

- time-history analysis; this may be applied in all cases, but it is required when an equivalent linear analysis cannot be used;
- full modal analysis;
- simplified modal analysis;
- simplified analysis.

6.5.4.2 Simplified modal analysis

This type of analysis may be used when the superstructure and the substructure including foundations may be assumed as rigid when compared to the isolation system. Also, the vertical stiffness of the isolation system is high compared to the horizontal one. In that case, the flexibility of the structure is concentrated at the isolation interface and the movement is fully described by three degrees of freedom: two horizontal translations and the torsional movement about the vertical axis. The latter is due to the eccentricity of the centre of mass to the centre of stiffness of the devices and also to the accidental eccentricity.

Consistently with eqn. (6.4), the effective period of translation is defined as:

$$T_{eff} = 2\pi \sqrt{\frac{M}{K_{eff}}} \quad (6.11)$$

To be consistent with the assumption of the analysis, the conditions below should be fulfilled:

- a) the distance from the site to the nearest potentially active fault with a magnitude $M_s \geq 6,5$ is greater than 15 km;
- b) the largest dimension of the superstructure in plan is no greater than 50 m;
- c) the substructure is sufficiently rigid to minimise the effects of differential displacements of the ground;
- d) all devices are located above elements of the substructure which support the vertical loads;
- e) the effective period T_{eff} satisfies the following condition:

$$3T_f \leq T_{eff} \leq 3 \text{ s} \quad (6.12)$$

where T_f is the fundamental period of the superstructure with a fixed base;

- f) the lateral-load resisting system of the superstructure is regularly and symmetrically arranged along the two main axes of the structure in plan;
- g) the rocking rotation at the base of the substructure is negligible;
- h) the ratio between the vertical and the horizontal stiffness of the isolation system should satisfy the following expression:

$$\frac{K_v}{K_{\text{eff}}} \geq 150 \quad (6.13)$$

- i) the fundamental period in the vertical direction, T_v , should be not longer than 0,1 s, where:

$$T_v = 2\pi \sqrt{\frac{M}{K_v}} \quad (6.14)$$

6.5.4.3 Simplified analysis

The simplified analysis is a further simplification of the previous one, which applies to buildings where the natural eccentricity is limited. The conditions of applicability are the same as in section 6.5.4.2, with the additional condition that, in both directions, the total eccentricity (including the accidental eccentricity) between the stiffness centre of the isolation system and the vertical projection of the centre of mass of the superstructure does not exceed 7,5% of the length of the superstructure transverse to the horizontal direction considered.

In that case, the movement consists of pure translational in two orthogonal planes, with the same period, same displacement and same inertial forces.

- o Displacement of the superstructure (S_e is the elastic spectrum):

$$d_{\text{dc}} = \frac{M S_e(T_{\text{eff}}, \xi_{\text{eff}})}{K_{\text{eff},\text{min}}} \quad (6.15)$$

- o Lateral force applied at each level of the superstructure (m_j is the mass of the level j):

$$f_j = m_j S_e(T_{\text{eff}}, \xi_{\text{eff}}) \quad (6.16)$$

Torsion should nevertheless be taken into account. This may be done in each individual isolator by amplifying in each direction the action effects above with a factor δ_{xi} given (for the action in the x direction) by:

$$\delta_{xi} = 1 + \frac{e_{\text{tot},y}}{r_y^2} y_i \quad (6.17)$$

where

- o y is the horizontal direction transverse to the direction x under consideration;
- o (x_i, y_i) are the co-ordinates of the isolator unit i relative to the effective stiffness centre;
- o $e_{\text{tot},y}$ is the total eccentricity in the y direction;
- o r_y is the torsional radius of the isolation system, as given by the following expression:

$$r_y^2 = \frac{\sum (x_i^2 K_{y_i} + y_i^2 K_{x_i})}{\sum K_{x_i}} \quad (6.18)$$

- K_{x_i} and K_{y_i} are the effective stiffness of a given unit i in the x and y directions, respectively, and are equal in most cases.

6.6 Example

The interest of base isolation can be assessed from two points of view:

- the point of view of dynamic efficiency, as has been discussed in section 6.2.2.2;
- the economical point of view: a design including base isolation has to be compared with the basic solution without base isolation. The latter benefits from the use of a behaviour factor the value of which is generally higher than that of the isolated building. On the contrary, the isolated building is submitted to an acceleration which does not increase much with height and neither does it need any detailing specific to ductile structures. As a consequence, an economical balance has to be met and a decision taken on a case by case basis. However, it should be noted that in cases where specific equipment has to be protected, as in hospitals or computer centres, f. i., base isolation is an excellent solution.

The economical point of view is no longer discussed in the example below and attention is focused on the base isolation concept.

The design example is recalled on Figure 6.6.1. The building is composed of a substructure separated from the ground by a peripheral retaining wall. This substructure therefore is rather rigid. The superstructure above level 0 is more flexible, with a composite bracing structure composed of walls and columns.

If base isolation is envisaged, the first question arising is: where should the isolation interface be placed? Two basic solutions may be envisaged:

- a) The isolation interface may be installed at level 0. It requires arranging the interface at the first level, so as to cut the walls and columns for the installation of the pads. On a structural point of view, this may be done quite simply, but the stiffness of the vertical elements should be checked to comply with the requirement concerning the control of differential movements. Also, a horizontal joint should be placed in non structural elements and façades, in stair and lift cases, which may prove more complicated to arrange.
- b) The isolation interface may be installed at the lower level of the substructure. In this specific case, the question of the retaining wall arises, as it cannot be included in the isolation as it does not allow for the required displacement capacity. So a vertical joint should separate somewhere the isolated structure from the retaining walls; this would probably necessitate adding vertical elements along the joint. Another solution is to build the structure within a pit.

It is clear from this discussion that it is not simple to arrange the isolation interface in most cases and that it is necessary to draw an adapted architectural design.

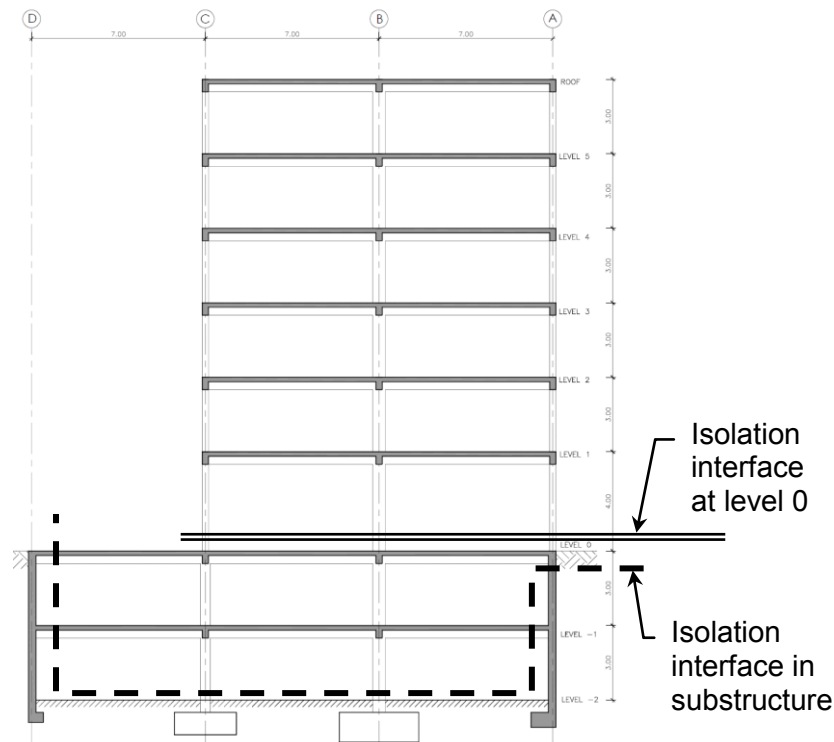

Fig. 6.6.1 Design example

Nevertheless, it can be examined whether base isolation may be envisaged at level 0. The fundamental periods of the upper part are 0,92 s and 0,68 s. So the superstructure is rather flexible, at least in one direction.

To obtain an efficient base isolation, a minimal value of β should be, say 3 f. i., which is lower than usual values. Period T_a should then be at least 3 s, which is high. This illustrates the fact that for that particular building base isolation is not very efficient.

We assume here that usual elastomeric pads are used, with mean properties recalled in section 6.3.1.

The mass of the superstructure being 2 362 T, the effective stiffness should be such that the effective period is 3 s, i. e.: $K_{eff} = 2\,362 \times (2\pi/3,0)^2 = 10\,361$ kN/m.

The total area of pads is determined by their vertical strength, which is determined either in the seismic situation or in a ULS fundamental combination of actions. In the latter case, if the ultimate strength is 10 MPa, the required area of pads is approximately $A = 2,362 \times 9,81 \times 1,4 / 10 = 3,25$ m², where 1,4 is an approximate value of the partial factor mixing 1,35 for permanent action and 1,5 for live loads.

This allows for determining the thickness of elastomer to fit with the total effective stiffness: $e = GA/K_{eff} = 1 \times 3,25 / 10,361 = 0,314$ m. In practical terms, the thickness is chosen according to the real production of pads. In this case, it is possible to utilise layers of 8 mm, which gives a thickness of 32 cm of elastomer, to which the thickness of steel plates has to be added.

The pads should be distributed under the main vertical elements, as shown on Figure 6.6.2.

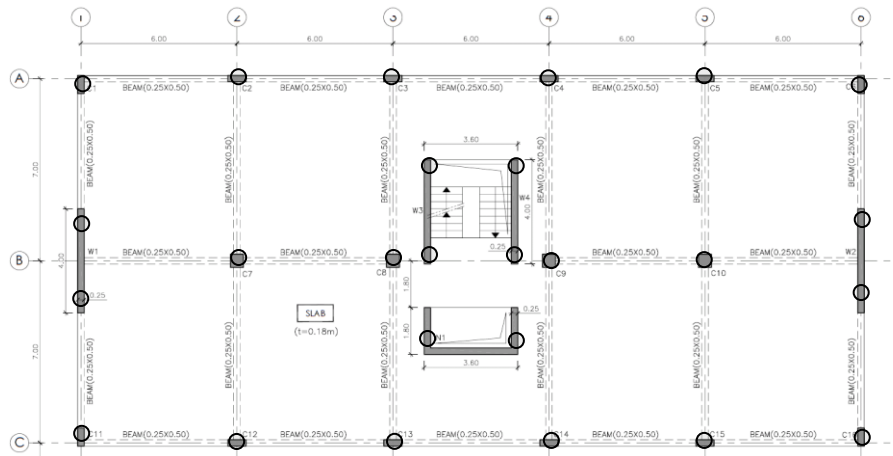

Fig. 6.6.2 Arrangement of isolating devices

With this assumption, 26 pads would be set under columns and walls, which leads to a mean area of $0,125 \text{ m}^2$, f. i. square pads $35 \text{ cm} \times 35 \text{ cm}$.

The seismic action to be taken into account is represented by a Type 1 spectrum, on soil B, with $a_g = 0,25g$. At 3 s, which is beyond T_D , the spectral acceleration is:

$$\begin{aligned}
 T_D \leq T \leq 4s: \quad S_e(T) &= a_g \cdot S \cdot \eta \cdot 2,5 \left[\frac{T_c T_D}{T^2} \right] \\
 &= 2,5 \times 1,2 \times \sqrt{\frac{10}{12}} \times 2,5 \left[\frac{0,5 \times 2,0}{3,0^2} \right] = 0,761 \text{ m/s}^2
 \end{aligned}
 \tag{6.19}$$

This value may be compared to those obtained when the base is fixed, i. e. $4,08 \text{ m/s}^2$ ($T = 0,92 \text{ s}$) and $5,51 \text{ m/s}^2$ ($T = 0,68 \text{ s}$) on the elastic spectrum ($q = 1$), without damping correction. It can be seen that, even with a rather low efficiency of the isolation, the acceleration is low compared to that obtained when using a behaviour factor, 5 for instance. However, the cost is probably higher due to the arrangement of foundations and to devices.

With these assumed values, the displacement of the superstructure would be $0,761 / (2\pi/3,0)^2 = 0,174 \text{ m}$. As a consequence, the distortion of the elastomer would be $17,4 / 32 = 0,55$ which is very low. For the verification of the devices, this value must be multiplied by δ and γ_x . The total shear force at the level of the interface is $2 \cdot 362 \text{ T} \times 0,761 \text{ m/s}^2 = 1800 \text{ kN}$. This leads to another calculation of the displacement: $1,8 \text{ MN} / 10,361 \text{ MN/m} = 0,174 \text{ m}$.

Of course, this is a very preliminary design and the devices should be verified according to their specific design and manufacturing, and a detailed analysis performed according to section 6.5. However, in the case of elastomeric pads, it is foreseeable that they would be hardly justified because of their thickness relative to their horizontal dimensions, which would induce stability problems. Solutions would be to choose completely different types of devices or to decrease the thickness, but in that case the efficiency and therefore the interest of base isolation would decrease rapidly. This confirms that base isolation is not suitable for this building, unless the architectural design is changed.

References

- EN 1998-1:2005. Eurocode 8 : Design of structures for earthquake resistance. Part 1: General rules, seismic actions and rules for buildings. CEN.*
- EN 1998-2:2005. Eurocode 8 : Design of structures for earthquake resistance. Part 2: Bridges. CEN.*
- EN 15129:2009. Anti-seismic devices. CEN.*
- EN 1337-3:2005. Structural bearings. Part 3: Elastomeric bearings. CEN.*

CHAPTER 7

Eurocode 8 Part 3. Assessment and retrofitting of buildings

P.E. Pinto and P. Franchin

University of Rome, La Sapienza

7.1 Introduction

In most cities of Europe, the existing relatively small historical centers (often having a history of destructions due to earthquakes of their own) have been surrounded in the last few decades by large new urban areas of both residential and industrial destination.

In the same decades, while engineering seismology and earthquake engineering were making fast and decisive scientific progresses, transfer of the newly acquired knowledge into practical provisions for seismic design took place at a much slower pace, and a larger further gap occurred between the appearance of modern proposals of normative documents and their official enforcement. In some European countries, this enforcement is not more than a few years old.

It doesn't come as a surprise, then, that the building inventory, including constructions of quite recent completion, is generally seismically deficient, in terms of both safety and economic protection, as systematically and dramatically demonstrated by all recently occurred seismic events.

Though it is obvious that a generalized seismic upgrading of the built environment would pose a tremendous economic burden, for both private and public owners, and would require a very long term planning, a task not all European governments are so much accustomed to, knowledge of the degree of risk actually affecting individual buildings represents in any case a precious element of information in view of future action.

Seismic assessment of an existing, non conforming structure, however, is a difficult art, one for which the normal engineer is ill-prepared and was, until recently, without much assistance in the form of normative or pre-normative documents.

Part 3 of Eurocode8 (EN1998-3, 2005) is a modern document, fully aligned with the recent trends regarding performance requirements and check of compliance in terms of displacements, providing also a degree of flexibility to cover the large variety of situations arising in practice.

In spite of the efforts made to make it rational and to introduce into it results from purposely made original research, the fact remains that EN 1998-3 cannot enjoy the support coming from a sufficiently long experience of use. Hence, it can be easily anticipated that its extended use will provide suggestions for improvements.

Due to the recognized inadequate knowledge on the post-elastic behaviour of generally poorly detailed structural members, the normative part of EN 1998-3 covers only material-independent concepts and rules, while verification formulas are given in Informative Annexes, whose use is not mandatory, and can be replaced by National documents.

The presentation to follow concentrates essentially in the general part, and includes some ideas deriving from a certain experience gained by the authors in assessing a number of structures. When not otherwise stated, reference is made to the assessment of RC structures.

7.2 Performance requirements and compliance criteria

7.2.1 PERFORMANCE REQUIREMENTS

The performance requirements are formulated in terms of the three Limit States (LS), as reported

below.

- LS of Near Collapse (NC). The structure is heavily damaged, with low residual lateral strength and stiffness although vertical elements are still capable of sustaining vertical loads. Most non-structural components have collapsed. Large permanent drifts are present. The structure is near collapse and would probably not survive another earthquake, even of moderate intensity.
- LS of Significant Damage (SD). The structure is significantly damaged, with some residual strength and stiffness, and vertical elements are capable of sustaining vertical loads. Non-structural components are damaged, although partitions and infills have not failed out-of-plane. Moderate permanent drifts are present. The structure can sustain after-shocks of moderate intensity. The structure is likely to be uneconomic to repair.
- LS of Damage Limitation (DL). The structure is only lightly damaged, with structural elements prevented from significant yielding and retaining their strength and stiffness properties. Non structural components, such as partitions and infills, may show distributed cracking but the damage could be economically repaired. Permanent drifts are negligible. The structure does not need any repair measure.

The appropriate level of protection against the exceedence of the three Limit States is achieved by associating to each of them a value of the return period (T_r) for the design seismic action.

The specific values to be adopted for the T_r 's are left for the National Authorities to decide, the suggestions being 2475, 475 and 225, respectively.

The same Authorities are free to ask for explicit check of a reduced number of LS's, down to just one. This flexibility is motivated essentially by economic considerations: for example, one owner may be content of ensuring protection against the state of Significant Damage (this SL is roughly equivalent to the "no collapse" requirement in Part 1 of EN 1998, whose main aim is to safeguard the life of the occupants), and it is possible that satisfaction of this LS is less demanding, in terms of cost of the intervention than the cost involved for satisfying the DL limit state.

Comment

As anticipated in the introduction, EN 1998-3 is a displacement based document, a formula implying that the direct analysis/verification quantities are the displacements and corresponding distortions induced by the seismic action having the selected average return period.

With the exception discussed later, use of the traditional q-factor, intended to cater globally for the dissipative behaviour of the structure, is abandoned, and the appropriate seismic action is introduced in the analysis without any modification.

This is a fundamental departure from the standard approach to be found in the present design provisions for new buildings, notably EN 1998-1. It is indeed a fortunate circumstance that this relatively new approach has reached a maturity and a general consensus at the time and for the purpose for which it is the most appropriate tool.

Existing buildings actually represent a very inhomogeneous population, in terms of age and criteria used for their design, and with unknown weaknesses, such that their overall inelastic behaviour can hardly be represented by a single parameter established *a priori*, such as the q-factor, even if differentiated for necessarily broad categories.

Besides, there is no more question among earthquake engineers that displacements/distortions are the quantities best suited for identifying the attainment of any of the above-defined limit states .

The difficult part, however, comes with the obvious necessity of calculating the buildings' response in stages well beyond the elastic one and close to their actual inelastic deformation capacity, on one hand, and of possessing enough information on this latter quantity, on the other. Both aspects are crucial for a reliable applicability of the document, and the development of better response and capacity models represent the challenge for its future improvement.

7.2.2 COMPLIANCE CRITERIA

The compliance criteria consist essentially in checking, for each LS, that the demands, calculated by using the allowed methods of analysis, do not exceed their corresponding capacities.

In the verification procedure, a distinction is made between “ductile” and “brittle” structural elements. The difference between the two applies both to the type of actions for which they are verified, and for the way the respective demands are evaluated. Ductile elements are checked in terms of deformation, brittle ones in terms of forces.

For what concerns the demands their evaluation is the same for both types if a non-linear method of analysis is used, while if the analysis is linear the procedure for determining action effects on the brittle elements is of the “capacity design” type. Details are given subsequently.

Comment

Before leaving this paragraph, a mention should be made to a problem of interpretation of the performance requirements that experience has shown to be at the origin of large discrepancies in the quantitative evaluations made by different experts on the same building.

It is noted that the description of the requirements for all of the LS's is formulated in qualitative terms and refers to more or less severe states of damage involving the structural system *as a whole*. When turning to the verification phase, however, the letter of the code appears to ask that in order for the requirements be satisfied all individual elements should satisfy the verification inequalities, which would lead to consider a building as seismically deficient even in the extreme case where a single element would be found as nonconforming.

In other words, there appears to be little if any freedom left to the evaluator to judge whether, even in presence of some nonconforming elements variously distributed across the structural system, the requirements in their general formulation are satisfied. As stated at the beginning, it would be quite beneficial to provide some general guidance on this issue, in order to reduce the large observed variability in the results obtained by different users of the code.

7.3 Information for structural assessment

7.3.1 KNOWLEDGE LEVELS

Amount and quality of the information usable for the assessment is discretized in EN 1998-3 into three “levels”, called “Knowledge Levels” (KL), ordered by increasing completeness. The information refers to three aspects: **Geometry**, **Details** and **Materials**. The term **Geometry** includes structural geometry and member sizes, **Details** refer to the amount and layout of reinforcement (for RC structures), **Materials** to the mechanical properties of the constituent materials. The following Table 7.3.1 reproduced from the code summarizes the definition of the levels. The quantitative definition of the terms used in Table 7.3.1: **visual**, **limited**, **extended**, **extensive** and **full**, as applicable to the knowledge of Geometry, Details and Material is given in the Code (as a recommended minimum, if not otherwise specified in National Annexes). In particular, for what concerns the levels of inspection and testing, the recommended requirements are reported in Table 7.3.2.

Table 7.3.1 Knowledge levels.

Knowledge Level	Geometry	Details	Materials
KL1	From original outline construction drawings with sample visual survey <i>or</i> from full survey	Simulated design in accordance with relevant practice <i>and</i> from limited <i>in-situ</i> inspection	Default values in accordance with standards of the time of construction <i>and</i> from limited <i>in-situ</i> testing
KL2		From incomplete original detailed construction drawings with limited <i>in-situ</i> inspection <i>or</i> from extended <i>in-situ</i> inspection	From original design specifications with limited <i>in-situ</i> testing <i>or</i> from extended <i>in-situ</i> testing
KL3		From original detailed construction drawings with limited <i>in-situ</i> inspection <i>or</i> from comprehensive <i>in-situ</i> inspection	From original test reports with limited <i>in-situ</i> testing <i>or</i> from comprehensive <i>in-situ</i> testing

Table 7.3.2 Recommended minimum requirements for different levels of inspection and testing.

	Inspection (of details)	Testing (of materials)
	For each type of primary element (beam, column, wall)	
Level of inspection and testing	Percentage of elements that are checked for details	Material samples per floor
Limited	20	1
Extended	50	2
Comprehensive	80	3

7.3.2 CONFIDENCE FACTORS

Allowing a structural assessment to be carried out for different levels of knowledge requires that a proper account is taken of the corresponding different amounts of uncertainties, these latter clearly applying to all of the three quantities: Geometry, Details and Materials.

The choice made by EN 1998-3 is to condense all types of uncertainties into a single factor, to be applied only to the mechanical properties of the materials. This factor, called **Confidence Factor** (CF), has a double use.

It is used in the calculation of the capacities, where the mean values of the material properties, as obtained from available information and from *in-situ* tests, are divided by the value of the CF appropriate for the KL.

It is also used as a multiplier of the mechanical properties of the ductile components when the strength of these latter is used to determine the actions affecting brittle components or mechanisms.

The suggested values of the CF are 1.35, 1.20 and 1.0 for KL1, KL2 and KL3, respectively.

Comment

The reliability format adopted by EN 1998-3, as briefly summarized above, to account for the different nature of the uncertainties characterizing the assessment process, as contrasted with those characterizing the design process, has the advantage of simplicity, but is subject to a number of practical and also theoretical limitations that will have to be addressed and hopefully improved in future editions of the Code. A brief discussion of some of these issues is presented in the following.

- The present close relation between the number of in-situ material tests and the Knowledge Level conveys naturally the idea that the more this number is increased the higher is the KL achieved. Actually, however, the increase of the number of tests has the only effect of reducing the standard error in the estimate of the mean (assuming that the materials tested belong to a single population, which in many cases is questionable). Also, while it often occurs that a larger number of tests leads to a greater dispersion of the mechanical properties, this information gets lost, since mean values only (not the characteristic ones) are used both in the analysis and in the verifications (the latter are carried out by applying the standard gamma values and the CF directly to the mean values).
- In the majority of cases, seismic assessments are being carried out not because of planned renovation or extension works, or because of a visibly precarious structural state of a building. They are mostly required by Public Authorities who want to be aware of the state of risk of their building stock consisting, for example, of schools, hospitals, administration offices, state banks, etc.
- A good knowledge would require availability of the original design drawings, as well as of the as-built ones, and full documentation on material tests, all of this complemented by some *insitu* test intended to confirm the design specifications and the present state of the materials.
- Availability of original drawings can be ruled out for masonry buildings dating one or more centuries (there is plenty of this category all over Europe), but the same situation applies at least in some countries for pre-WWII RC buildings, and continues until well into the late Sixties of the last century.
- For RC buildings, complete or partial lack of the original drawings, i.e. of the structural **geometry** and of the **details**, could in theory be remedied by a more or less extensive survey and *in-situ* inspections.
- All mentioned public buildings, however, are in continuous use, which makes it completely impractical to collect the needed information by exposing sufficient portions of the concrete structure, examining reinforcement layout and taking steel and concrete samples. Quite often, also, the structural elements are not directly visible, being incorporated into non-structural elements such as partition walls, masonry infills, suspended ceilings, etc.
- For masonry buildings, missing information can often be collected with relatively minor effort and more confidence: since they are not engineered structures, they normally follow rather uniform construction rules regarding, for ex., regularity in plan and in elevation, distance of the main walls, vertical alignment of the openings, etc., so that at least their basic structural geometry can be reconstructed with minor uncertainty.

The preceding considerations are intended to emphasize that, in all those cases where assessment is conducted with the structure still in use, the major sources of uncertainty inevitably refer to geometry and details, more than to materials. The former are not only more relevant than the latter, they are different in nature. They are in principle removable, if surveys and investigations were possible to the point of allowing the setting up of a fully realistic structural model, but this is seldom if ever the case. It is equally quite rare in many countries to be able to start the assessment process on the basis of a complete and credible design documentation. This being the situation, two consequences follow.

- In the first place, one recognizes that the Confidence Factor covers only one part of the overall uncertainty, i.e., that related to the material properties, whose role is in the majority of cases secondary.
- The uncertainty on geometry and details cannot be covered with factors, since a certain element is there or it is not, with a particular arrangement of the reinforcement or with another, and so on, and one is not in the position of ascertaining the real situation.

Also the latter kind of uncertainty falls well within the domain of classical theory of probability. In short, and having in mind a simplified treatment of it to be proposed for use in practice, it involves consideration of alternative assumptions on the state of the most influential subjects of uncertainty (presence and/or dimension of some structural components, quantity and arrangement of reinforcement, etc.), each assumption being weighted by a factor between 0 and 1, representing the subjective degree of belief of the analyst on each alternative assumption, based on his experience.

This approach has the fundamental advantage of providing an assessment not expressed in terms of a single value of the seismic intensity leading to the attainment of the specific LS of interest, but a distribution of values, from which various statistical measures can be extracted, such as the mean, the standard deviation, and various confidence intervals.

An elementary example of this approach is given at the end of this chapter.

7.4 Method of analysis

In accordance with the displacement criterion adopted in EN 1998-3 for checking satisfaction of the various performance requirements, the seismic action to be used in conjunction with all allowed methods of analysis consists of the elastic response spectrum characterized by the appropriate value of its average return period.

As an exception to this general approach the possibility is also given of using the q-factor approach, with a reference value of q equal to 1.5 for reinforced concrete buildings, and of 2.0 for steel buildings. Masonry buildings are not mentioned. The use of higher values of q is subject to adequate justification on the basis of the available ductility, both local and global.

The exception is intended to cover cases of obviously over-dimensioned buildings, or of quite recent buildings designed for earthquake resistance according to previous codes, or in places where the seismicity level has been revised upwards.

The allowed analysis methods are the same given in EN 1998-1:

- Linear analysis, using statically applied lateral forces or modal response spectrum analysis
- Non-linear analysis, either static (push-over) or dynamic using spectrum-compatible accelerograms.

Use of linear static analysis is permitted under the same conditions given in EN 1998-1, i.e., geometrical regularity in elevation, and values of the fundamental period less than or equal to 2.0s and to $4T_C$, where T_C is the corner period after the flat part of the spectrum, to which a further condition of “uniformity of inelastic demand” is added.

This extra condition refers to the ratios $\rho_{oi}=D_i/C_i$ between the demand D_i obtained from the analysis and the corresponding capacity C_i for the i-th “ductile” primary elements of the structure, and requires that over all primary elements of the structure for which ρ_{oi} is larger than 1 the ratio ρ_{oMax}/ρ_{oMin} does not exceed a maximum acceptable value in the range of 2 to 3.

Use of modal response analysis is permitted under the same condition of “uniformity of inelastic demand” described above.

For masonry structures, applicability of linear methods, both static and multi-modal, is subject to the following restrictive conditions (though, somewhat strangely, these restrictions are not given in the normative document but in the informative Annex):

- The lateral load resisting walls are *regularly* arranged in both horizontal directions.
- *Walls are continuous along their height.*
- The floors possess enough in-plane stiffness and are sufficiently connected to the perimeter walls to assume that they can distribute the inertia forces among the vertical elements as *rigid diaphragm*.
- *Floors on opposite sides of a common wall are at the same height*
- At each floor, the ratio between the lateral in-plane stiffness of the stiffest wall and the weakest primary seismic wall, evaluated accounting for the presence of openings, does not exceed 2.5.

With restrictions like these it can be anticipated that linear analysis will not be frequently used for masonry structures.

Non-linear analyses, both static and dynamic, are permitted in all cases.

Dynamic analysis, in particular, is unrestricted and without specific requirements, leaving to the analyst the responsibility of making the proper choices for obtaining accurate results.

For non-linear static analysis, the code prescribes the use of at least two vertical distributions of lateral loads:

- a “uniform” pattern, with lateral forces proportional to the masses at all elevations
- a “modal” pattern, with lateral forces proportional to the product of the mass matrix by the relevant modal vector.

It is noted that the above prescriptions and the overall procedure is the same as in EN 1998-1, hence they reflect the state of this technique in the early 2000s. Progress has occurred since then, and experience has also been gained in the application of the method to the assessment of a large number of buildings.

The version presented in Part 1 of EN 1998 (the N2 method, Fajfar and Gaspersič 1996) was originally devised for planar, single-mode dominated structures, and makes use of two structure-independent load patterns. Its extension to unsymmetrical buildings consists of a rather hybrid procedure, whereby the applied loading pattern is still planar and structure-independent, and, to account for the dynamic amplification due to torsion, the displacements on the stiff-strong side as obtained from the pushover are increased by a factor based on the results of a spatial modal analysis.

Several more direct proposals are now available in the literature that can account for multiple modes contribution, including of course torsional modes, and recourse to such methods is explicitly allowed in a note of EN 1998-3 (note at 4.4.4.5). One of these methods, due to Chopra and Goel (2002, 2004), in spite of its inherent approximation which is common to all multi-mode methods (i.e., making use of superposition of effects in the non-linear range, and also of the modal combination rules valid for elastically responding structures), has shown to provide acceptably accurate results and offers the advantage of being a rather straightforward extension of the original N2 method.

In this method a set of fixed loading patterns is considered, each one given by the product of the mass matrix by one of the selected mode shapes (hence a spatial loading pattern). A pushover analysis is carried out for each pattern with the maximum displacement obtained from the response spectrum. All desired response quantities (member chord rotations and forces, joint principal stresses, etc) are then calculated mode by mode and combined using the SRSS (or CQC) rule. The SRSS rule can also be applied for combining the maxima due to the two horizontal components of the seismic action, leading to the final expression for the generic scalar response quantity R :

$$R = R_G + \sqrt{\sum_{i=1}^N (R_{i,E_X} - R_G)^2 + (R_{i,E_Y} - R_G)^2} \quad (7.1)$$

where the summation is over the N considered modes, R_{i,E_X} and R_{i,E_Y} are the values of the response quantity for mode i due to the X and Y component of the seismic action, and R_G is the response under gravity load. This latter must be subtracted from those due to the seismic action, since all the pushover analyses start after the application of the gravity loads. In general, the modal responses in equation (7.1) must be evaluated for both signs of the load patterns, since $R_{E_X} \neq -R_{-E_X}$.

A problem arises with the use of equation (7.1) **Error! Reference source not found.** for the determination of member forces, since the contribution of all modes are summed up with positive signs, and this may lead for ex. to unrealistic demands in terms of bending moments as well as to shear force values that are not in equilibrium with the bending moments at the member ends.

Equally unsolvable in rigorous terms is the problem of shear verification of columns, due to the uncertainty in the evaluation of the normal force. A larger axial force increases the flexural strength at the end, hence the shear demand (through equilibrium); on the other hand, it increases also the shear capacity with ensuing uncertainty on the value of the ratio D/C.

An approximate solution to the last problem, in analogy with the definition of some damage indices or the Miner's rule for fatigue, consists in evaluating the D/C ratio (i.e. the ratio $V_i(N_i)/V_R(N_i)$) for each mode (conserving signs and not violating equilibrium or constitutive laws) and in using the modal combination rule on these ratios. The verification would then be:

$$\sqrt{\sum_{i=1,N} (V_i(N_i)/V_R(N_i))^2} \leq 1 \quad (7.2)$$

In practice the difficulties discussed above are often made less severe by the fact that for many structures the response is predominantly governed by just one mode for each direction of the seismic action, in which case the summation in equation (7.1) is little affected by the contribution of higher modes. In the limiting case where only one mode would be significant for each direction of the seismic action equation (7.1) would reduce to:

$$R = R_G + \sqrt{(R_{i,E_X} - R_G)^2 + (R_{j,E_Y} - R_G)^2} \quad (7.3)$$

7.5 Verifications (Reinforced Concrete structures)

7.5.1 DEMAND QUANTITIES

For *ductile members* (beam-columns and walls in flexure) the demand quantity is the chord-rotation at the ends, *as obtained from the analysis, either linear or non-linear.*

For *brittle mechanisms* (shear in member and joints) the demand quantity is the *force* acting on the mechanism, to be determined differently according to the adopted method of analysis, as follows:

- For non-linear methods: the value of the force is that obtained from the analysis.
- For linear methods: the value of the force is the one transmitted by the adjoining ductile members through equilibrium conditions, specifically:

- if the structure responds elastically ($D_i/C_i < 1$) the value of the force obtained from the analysis;
- if the members are in post yielding state, in the equilibrium condition the capacity of the ductile members is calculated using mean values of the material properties *multiplied* by the appropriate value of the CF.

7.5.2 MEMBERS/MECHANISMS CAPACITIES

The capacities of *ductile* members are calculated using the mean values of the material properties as obtained from the collected information, divided by the appropriate value of the Confidence Factor.

In the case of *brittle* members the values of the material properties are further divided by the usual partial factors.

The different procedures to be adopted for evaluating demands and capacities for the cases of linear or non-linear types of analysis are illustrated in Table 7.5.1.

Table 7.5.1 Summary of the verification procedure for ductile and brittle mechanisms.

		Linear Model (LM)		Non-linear Model	
		Demand	Capacity	Demand	Capacity
Type of element or mechanism (e/m)	Ductile	Acceptability of Linear Model (for checking of $\rho_i = D_i/C_i$ values)		From analysis. Use mean values of properties in model.	In terms of deformation. Use mean values of properties divided by CF.
		From analysis. Use mean values of properties in model.	In terms of strength. Use mean values of properties		
		Verifications (if LM accepted)			
		From analysis.	In terms of deformation. Use mean values of properties divided by CF.		
	Brittle	Verifications (if LM accepted)		From analysis. Use mean values of properties in model.	In terms of strength. Use mean values of properties divided by CF and by partial factor.
		If $\rho_i \leq 1$: from analysis.	In terms of strength. Use mean values of properties divided by CF and by partial factor.		
If $\rho_i > 1$: from equilibrium with strength of ductile e/m. Use mean values of properties multiplied by CF.					

7.5.3 VERIFICATION UNDER BI-DIRECTIONAL LOADING

A problem not explicitly dealt with in EN 1998-3 is how to carry out verification of both ductile and brittle elements under bi-directional loading. This is the normal condition under which members are subjected to due to the simultaneous application of multiple components of the seismic action, and

the lack of guidance is the direct result of the lack of knowledge (theoretical, as well as experimental) on the biaxial deformation and shear capacities at ultimate.

With reference to the deformation capacity, a limited experimental evidence (Fardis, 2006) supports the use of an “elliptical interaction” domain at ultimate (Figure 7.5.1). Proceeding as for equation (7.2) on a mode by mode basis, the bidirectional demand to capacity ratio (BDCR) would read:

$$BDCR_i = \sqrt{\left(\frac{\theta_{2i}}{\theta_{2u,i}}\right)^2 + \left(\frac{\theta_{3i}}{\theta_{3u,i}}\right)^2} \quad (7.4)$$

where θ_{2i} and θ_{3i} are the contributions of the i -th mode to chord-rotations in planes 1-2 and 1-3 (axis 1 being the longitudinal one), and $\theta_{2u,i} = \theta_{2u}(N_i)$ and $\theta_{3u,i} = \theta_{3u}(N_i)$ are the corresponding uniaxial capacities at ultimate. Using the SRSS rule to combine the modal contributions the verification consists in checking that $\sqrt{\sum_{i=1}^N BDCR_i^2} \leq 1$.

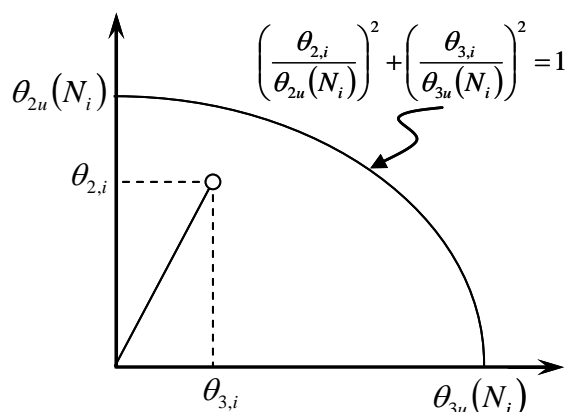

Fig. 7.5.1 Elliptical interaction diagram for chord-rotation at ultimate.

No comparable experimental evidence exists with regard an interaction domain for biaxial shear. It is proposed to adopt a similar format as that of equation (7.4).

7.6 Discussion

7.6.1 INTRODUCTION

The experience of several applications to real cases carried out in recent years has provided precious information on the practical applicability of EN 1998-3. The following discussion concentrates on one central problematic aspect of this code, which it shares with all other available assessment documents, i.e. the large dispersion characterizing the assessment outcomes. The sources of this dispersion are explored and a possible consistent procedure for dealing with the problem is outlined.

7.6.2 THE ANALYST'S DEGREES OF FREEDOM

As previously discussed, the present version of EN 1998-3 allows several analysis methods, together with respective applicability criteria, though it does not provide either indications on aspects such as *nonlinear modelling*, nor guidance on how to “aggregate” the results of the member-level verifications into an overall quantitative measure of satisfaction of globally defined LS's. It is on aspects like those mentioned that different analysts may make choices that turn out to be consequential on the assessment end results. This is shown in the next section, where a simple example of a plane RC frame (Rajeev, 2008) is employed to highlight the latitude of the results that can be obtained.

7.6.3 VARIABILITY IN THE RESULTS OF NOMINALLY “EQUIVALENT” ASSESSMENTS

Figure 7.6.1 shows a six-storeys, three-spans plane RC frame. Beams have constant cross-section 250mm×700mm, while columns' cross-section varies between 250mm×400mm at the top and 400mm×900mm at the bottom. Detailed information on sections and reinforcement details can be found in (Rajeev, 2008). As far as materials are concerned, mean strength values are $f_c = 20\text{MPa}$, $f_y = 275\text{MPa}$, and $f_m = 4.4\text{MPa}$ for the infills (a value that corresponds to clay hollow-core units with a void ratio of about 45%, that have a modulus $E_m = 750f_m$). The analyses reported in what follows assume a knowledge level KL3, which is paired with a CF=1.

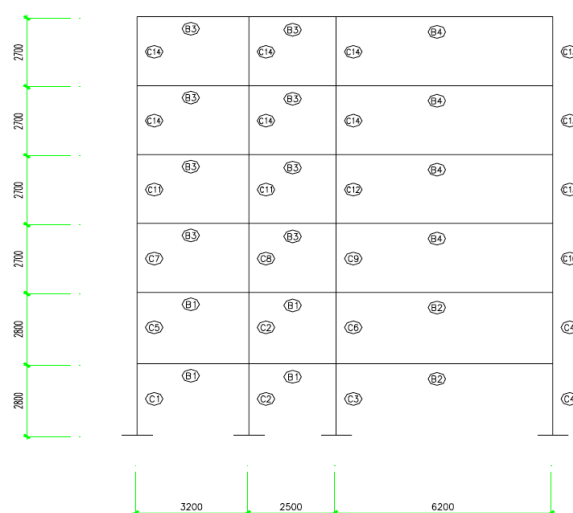

Fig. 7.6.1 Six-storeys plane RC frame.

The seismic assessment of the frame is performed fictitiously by a number of distinct analysts. Each analyst is assumed to make independent choices on a number of aspects.

For the sake of illustration not all the admissible choices are considered within this example. They refer only to *response analysis*, the *input data* and the *shear strength capacity model*. In particular five choices are considered:

- Response: both non-linear *static* (NLS) and *dynamic* (NLD) are considered (larger variability in the response might have been observed in case *linear* would also be included). Dynamic analyses have been carried out with a suite of seven spectrum-compatible records (Rajeev, 2008) that match the response spectrum used for the static analyses (dynamic results are the average over the seven records);

- Response: use of a standard fibre model with stable hysteretic behaviour, called *basic modelling* (B), versus use of a plastic hinge with section stress resultant-deformation degrading laws in both flexure and shear (the hinges drop load when flexural deformation reaches θ_u or shear deformation exceeds γ_u), denominated *advanced modelling* (A) The latter modelling option allows to follow the sequence of local failures and their consequences on the global behaviour.
- Response: inclusion (T) or exclusion (NT) from the model of non-structural infill panels strength/stiffness (non-linear modelling with equivalent bilinear compression-only struts with degrading behaviour);
- Input data: two values (ρ_{min} and ρ_{max}) for the geometric percentage of longitudinal reinforcement in the columns (values that are supposed to represent outcomes from two quantitatively equivalent but differently planned test/inspections campaigns);
- Shear strength capacity model: use of two different models, one by Biskinis et al (2003) (BF) which is included in the informative annex to EN 1998-3, the other by Kowalsky and Priestley (2000) (PK).

It can be observed that several more sources of uncertainty could have been included, such as, e.g., geometrical dimensions of members, joint reinforcement patterns and joint response and capacity models, floor slab mass, damping model and amount, etc.

It is apparent how a large importance is attached to uncertainty stemming from response-determination, as three out of five of the considered choices are related to it. The motivation for this weight comes from practical applications that have shown how, often, at nominal parity of information on the structure and modelling options changing the analysis method, or within the same method, changing the modelling options, leads to non negligible differences. In assessing the results presented in what follows it should be noted that they have been obtained without changing the software which in all cases is OpenSEES. Differences could have easily been larger in case different modelling options and analysis methods were associated to different analysis packages.

Finally, before going through the results two remarks are due.

The first one concerns the adopted *verification criterion*. A single global quantitative measure is used, which is considered to be more consistent with the verbal qualitative definition of the LS. The criterion is formulated in terms of the floor drifts and, when shear failure is not included in the analysis (all analyses with the B modelling option), also in terms of the member shear D/C ratio. The global D/C ratio, called Y (Jalayer et al, 2007a,b) is defined as:

$$Y = \max \left(\max_{floors} \frac{\theta}{\theta_u}, \max_{columns} \frac{V}{V_u} \right) \quad (7.5)$$

$$Y = \max_{floors} \frac{\theta}{\theta_u} \quad (7.6)$$

$$Y = \max_t \max \left(\max_{floors} \frac{\theta(t)}{\theta_u(t)}, \max_{columns} \frac{V(t)}{V_u(t)} \right) \quad (7.7)$$

$$Y = \max_t \max_{floors} \frac{\theta(t)}{\theta_u(t)} \quad (7.8)$$

where expressions (7.5) and (7.6) hold for static analysis, with *basic* and *advanced* modeling, respectively, while expressions (7.7) and (7.8) hold for dynamic analysis.

The second aspect concerns the choice of a model for the shear strength capacity different from that provided in the Informative Annex of EN 1998-3. This choice is motivated by the fact that, since the

Annexes are, as already mentioned, informative and several models exist for the shear strength of RC members, an analyst may feel that a particular model is more suited for predicting the shear strength of the particular structure under assessment.

Figure 7.6.2 shows the two portions of the tree used to represent the combination of the 5 binary choices that have led to the $2^5=32$ alternative models/analysts. The figure shows also, beside the corresponding “leaves”, the values of the global D/C ratio Y outcome of each assessment.

It is immediate to observe a large variation in the assessment outcomes, which fall in the interval [0.200, 2.157]: the extreme values differ by an order of magnitude.

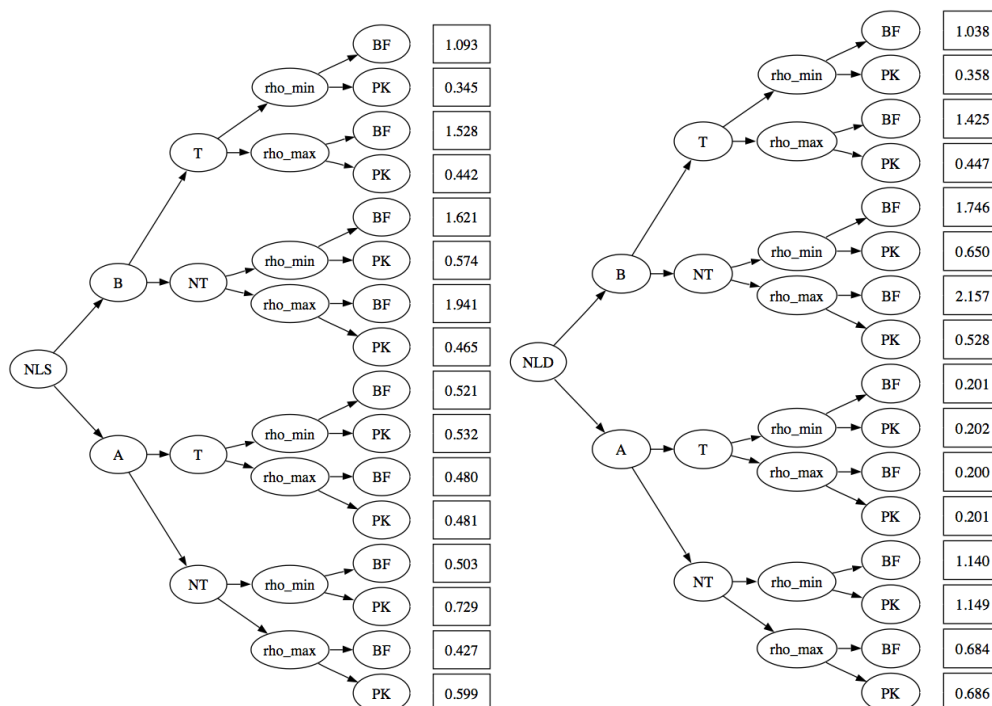

Fig. 7.6.2 Tree of analyses: for convenience of representation the full tree is separated into a non linear static portion (NLS, left) and a dynamic portion (NLD, right).

Next, in order to gain more insight into the influence of each choice in differentiating the assessment outcomes, the sample of 32 values of Y are considered iso-probable (no particular analysis is considered more likely than the others) and their cumulative distribution function is constructed. In particular, each of the following five plots shows the distribution of the 32 values as a reference (label “Ref.”), together with two distributions of 16 values each, obtained by dividing the total sample according to one of the five choices. Figure 7.6.3 shows the distribution obtained dividing by *method of analysis* (left plot, corresponding to the two sub-trees shown in Figure 7.6.2) and *geometric reinforcement ratio* (right). It can be observed how in both cases the distributions for the two subsets do not differ from the reference in a significant way. This means that neither the analysis method, nor the longitudinal reinforcement ratio of the columns provides significant contribution to the variability. As a side comment the resulting low significance of longitudinal reinforcement (varying between 0.8% and 1.2%) confirms results of previous analyses that have shown how, as far as limit states are formulated in terms of displacement/deformation quantities, ρ and more generally ρf_y have a relatively mild influence. In this particular case, moreover, the influence of this ratio is also masked by more influential choices such as those shown in Figure 7.6.4.

Specifically, the distribution plots in this figure show that basic modelling is consistently conservative (larger Y values) with respect to advanced modelling, as it is the EN 1998-3 shear strength model with respect to modified UCSD model, and the absence of the infills. Concerning the latter it can be

observed how the equivalent struts employed for their modelling have been connected to beam-column joints rather than to internal column elements close to the joints, and hence they do not directly contribute in increasing the column shears.

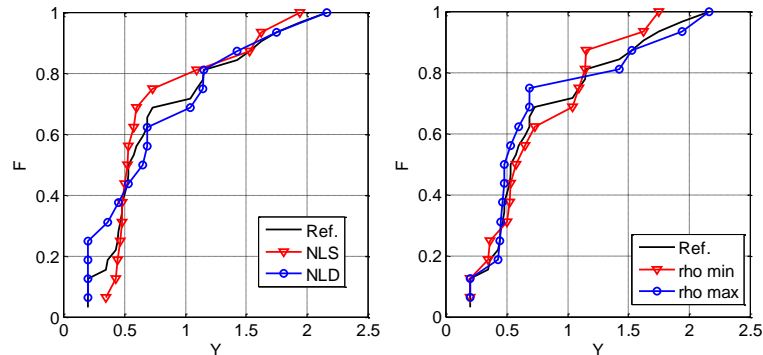

Fig. 7.6.3 Empirical CDF obtained by aggregating results by analysis method and reinforcement ratio.

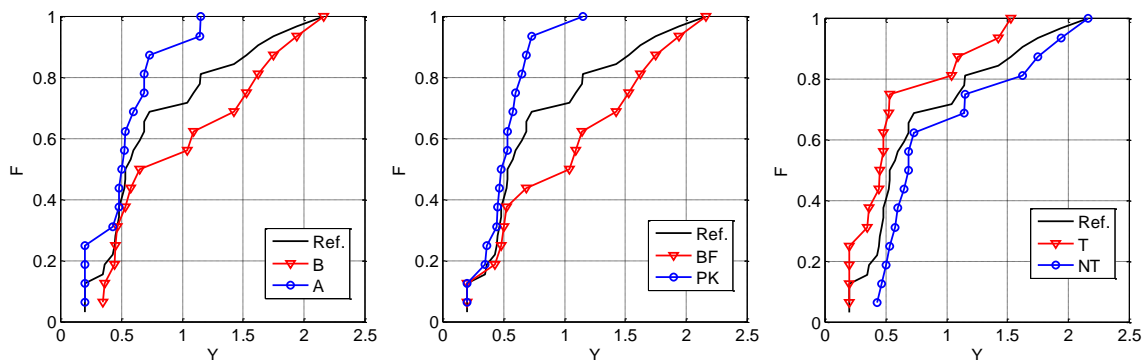

Fig. 7.6.4 Empirical CDF obtained by aggregating results by: modelling approach, shear strength capacity model, and inclusion/exclusion of masonry infills.

Comment

From the particular example examined it is clear that major influence on the variability of the outcomes is due to a number of fundamental uncertainties which are epistemic in nature. These are related to knowledge gaps on the response and capacity of members and hence can only be reduced through research in the mechanics, not by means of additional tests and inspections on the structure. As a consequence these uncertainties should be considered irreducible for the analyst and appropriately dealt with during assessment.

The next section outlines a possible procedure that starting from the recognition of the irreducible character of the above uncertainties, treats them explicitly by means of the “logic tree” technique.

7.6.4 PROPOSED ALTERNATIVE

Figure 7.6.5 shows the general flow chart of an assessment procedure for existing RC structures. The characterising elements of the procedure are:

- The reference analysis method is *non linear*. The role of *linear analysis* is that of a *preliminary tool*. A linear analysis may turn out to be sufficient to express a judgement in those few cases

where the structure possesses a clear over-capacity. In general, however, the function of linear analysis is to provide an approximate indication of the distribution and magnitude of deformations over the building height.

- Testing/inspections are planned based on the results of the preliminary analysis of the linear model, and aim at acquiring knowledge on material properties, details and geometry in the most critical areas, subject to the constraint imposed by the use of the building. It should be clear that the location of the tests is more important than their number.
- Based on the acquired knowledge, alternative models are set-up which reflect the options considered by the analyst to model uncertainties of the type presented in the previous section. Each option is also qualified with a subjective probability (see later).
- The assessment outcome consists in an approximate probability distribution of the global D/C ratio, from which statistics can be derived such as the mean, the dispersion, or a confidence interval.

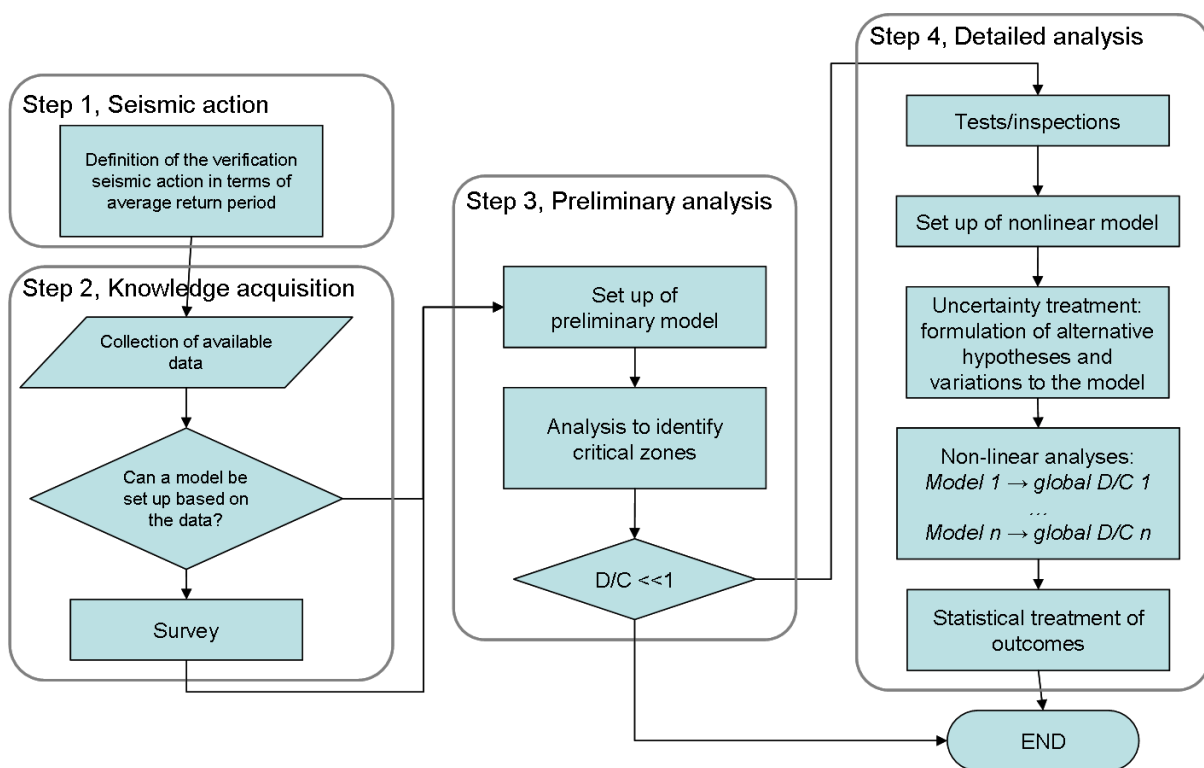

Fig. 7.6.5 Assessment procedure.

One possibility of managing the multiple models and their results is to employ the logic tree technique (NUREG, 1981). This is a statistical tool that allows the determination of the probability associated with a combination of alternative choices represented in the form of a tree. In the tree each branching point corresponds to one such choice, and each branch is assigned a subjective probability reflecting the degree of belief of the analyst in the corresponding alternative. The probabilities at each branching point sum up to one. The probability of the outcome at the end of the various branches (the “leaves”) is determined as the product of the probabilities of the preceding choices. The probabilities of the leaves also sum up to one.

The application of the logic tree is illustrated with reference to the example frame introduced in the previous section. The uncertainties considered in the construction of the tree are those that have shown to have more significance, i.e. the modelling strategy, the shear strength model and the

consideration of infills' contribution to response. The subjective probabilities weighting the choices are:

- Modelling: 0.6 for the *advanced* modelling, 0.4 for the *basic* one;
- Shear-strength model: 0.7 for EN 1998-3 model, 0.3 for the alternative one;
- Infills: 0.3 if present, 0.7 if absent.

Figure 7.6.6 shows the corresponding logic tree with assigned weight on the branches and the resulting weights of the final leaves. The square boxes beside the final leaves report the corresponding values of the global D/C ratio Y (all analyses are of the nonlinear static type and have been run with the minimum value of the geometric reinforcement ratio of the columns). Figure 7.6.7 shows the distribution of the Y values, together with the second moments values.

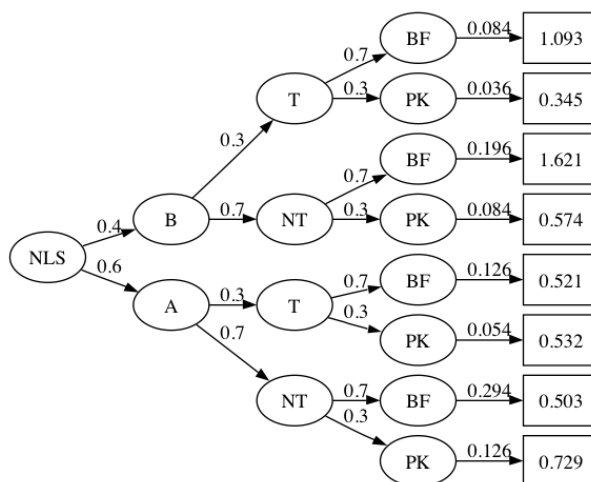

Fig. 7.6.6 Logic tree with indication of the probabilities assigned to each branch (over the branch) and of the resulting probabilities of the final leaves (on the arrow connecting the leaf with the corresponding assessment outcome, reported within a rectangle).

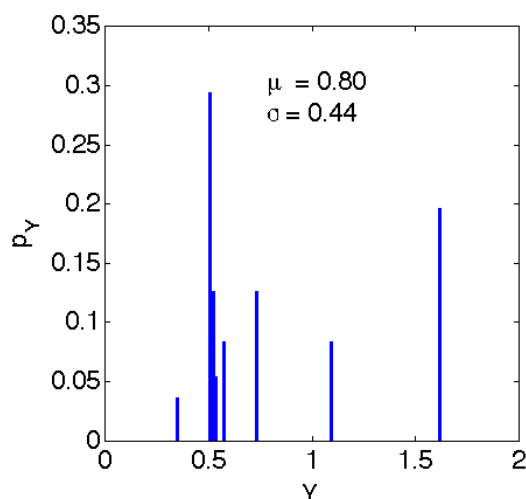

Fig. 7.6.7 Discrete probability distribution of Y .

The choices made for the alternatives and the corresponding subjective probabilities values lead in this case to a mean value lower than one, which implies satisfaction of the limit state, associated, however, with a relatively large value of the coefficient of variation, in the order of 50%.

In order to assess, within the limits of the example at hand, the robustness of the procedure with respect to the choice of the weights, mean and standard deviation of Y have been re-evaluated for two different weights values: in one case all choices have been considered iso-probable, and in the other one the weight attributed to the EN 1998-3 shear strength model has been raised to 0.9. Table 7.6.1 reports the results.

Table 7.6.1 Mean and standard deviation of Y for different weights assigned to tree branches.

Weights	Mean	Std. Dev.	CoV
Initial weights	0.80	0.44	55%
Isoprobable choices	0.74	0.48	65%
Weight of EC8-3 shear model = 0.9	0.86	0.39	45%

The table shows that statistical parameters remain quite stable with respect to weights variations. This fact, for how much is granted by the limited example, is important since the weights represent subjective probabilities not always easily established. Further, even if the example does not allow to demonstrate it, it is obvious that it is much more consequential for the procedure outcome, in that they determine the Y values, what uncertainties are included in the tree, and the specific alternative “levels” chosen for each branching point (e.g. in this example, the models selected as alternative descriptions of the shear strength).

7.7 Conclusions

The paper provides a brief overview of selected aspect of Part 3 of Eurocode 8. This document is characterised by several aspects that are in line with the present state-of-the-art in code-making, including it being an explicitly performance-based, displacement-based document, with a formal treatment of the epistemic uncertainty in the assessment. This structure makes it open to incorporate future necessary progresses in several areas where knowledge is still sorely missing. A major stress of the paper is in the attempt to highlight how the above knowledge gap leaves room for widely differing assessment outcomes. The entire Discussion section is devoted to this issue and a possible path to a solution is outlined.

Modelling uncertainty of epistemic nature is central to the assessment of an existing structure. The approach presently included in the code deals with such a problem by introducing a discrete number of so-called knowledge levels. At each level a value of the Confidence Factor is attached, value that increases with decreasing knowledge of the structure.

This approach has a limitation. Epistemic uncertainties in the assessment are of two types. One is in principle reducible through an increase in the testing/inspection activity, though in practice even such activity is severely hindered by the limited accessibility of the relevant areas, and more generally the continued use and integrity of the building. The second one, whose relevance is in many cases larger than that of the first one, is not related to the building being assessed but, rather, to the mechanical response and capacity models employed for the analysis. From the point of the view this kind of epistemic uncertainty is irreducible.

Of the two types of epistemic uncertainty just described, the former is amenable to a description in terms of random variables, representing e.g. material strengths, or reinforcement ratios, and hence can be dealt with through partial (confidence) factors. Uncertainty of the latter type cannot be overcome other than by introducing appropriately selected discrete alternatives for each of the most relevant models, based on the analyst previous experience.

An additional aspect that has been illustrated and commented in the paper can be at the origin of large differences in the assessment outcomes. This aspect is the lack of bi-univocal relationship between the qualitative definition of the ultimate limit states, which is clearly global, and the quantitative verification criteria that are specified at the member-level. The choice between different quantitative definitions of the global limit-state exceedance clearly belongs to the second type of epistemic uncertainty and could therefore be easily included within the tree.

In conclusion, a possible solution to the problem of explicit consistent treatment of the epistemic uncertainty could consist in replacing the current approach of the code, based on *single* analysis with “reduced” material strengths, with a procedure such as that in Section 7.6, which requires multiple analyses and employs a logic-tree approach to elaborate the results so as to obtain a statistical measure of the effect of the dominant uncertainties on the assessment outcome. Such a procedure would lead to an outcome which is both more reliable (the results would not be a point-estimate but a mean qualified with a dispersion) and articulated (the set of individual results is quite informative and allows a diagnosis on the factors affecting the outcomes).

The effort associated with such a procedure is recognisably larger than that required by the current code format. The opinion that this a larger modelling/computational effort is unavoidable in the case of existing structures is being increasingly accepted. The economic relevance of a more accurate and reliable assessment needs not to be over-stressed, since it is the base for fundamental decisions on the nature and impact of the structural retrofit interventions.

References

- Biskinis, D., G. Roupakias, and M.N. Fardis. 2003. *Cyclic deformation capacity of shear-critical RC elements. Proceedings, fib 2003 Symposium: Concrete Structures in Seismic Regions, Athens, Greece.*
- CEN. 2005. *European Standard EN 1998-1: 2005 Eurocode 8: Design of structures for earthquake resistance. Part 1: General rules, Seismic action and rules for buildings. European Committee for Standardization, Brussels, Belgium.*
- CEN. 2005. *European Standard EN 1998-3: 2005 Eurocode 8: Design of structures for earthquake resistance. Part 3: Assessment and retrofitting of buildings. European Committee for Standardization, Brussels, Belgium.*
- Chopra, A.K., and R.K. Goel. 2002. *A modal pushover analysis procedure for estimating seismic demands for buildings. Earthquake Engineering and Structural Dynamics* 31: 561-582.
- Chopra, A.K., and R.K. Goel. 2004. *A modal pushover analysis procedure to estimate seismic demands for unsymmetric-plan buildings. Earthquake Engineering and Structural Dynamics* 33: 903-927.
- Fajfar P, and P. Gaspersič. 1996. *The N2 method for seismic damage analysis of RC buildings. Earthquake Engineering and Structural Dynamics* 25: 31– 46.
- Fardis M. 2006. *Acceptable deformations of RC members at different performance levels under bidirectional loading. LessLoss Deliverable Report 64, URL <http://www.lessloss.org>*
- Franchin, P., P.E. Pinto, and P. Rajeev. 2010. *Confidence Factor?. Jnl Earthquake Engng, Taylor & Francis, 14(7): 989-1007.*
- Jalayer, F., P. Franchin, and P.E. Pinto. 2007. *A scalar damage measure for seismic reliability analysis of RC structures. Earthquake Engng & Struct. Dyn., Wiley, 36(13): 2059–2079.*
- Kowalsky, M., and M.J.N. Priestley. 2000. *Improved Analytical Model for Shear Strength of Circular Reinforced Concrete Columns in Seismic Regions. ACI Structural Journal* 97(3): 388–396.
- NUREG/CR-2300, 1981. *PRA Procedure Guide. US Nuclear Regulatory Commission, Washington, DC.*
- Rajeev, P. 2008. *Role of Confidence Factor in Seismic Assessment of Structures. PhD Thesis, ROSE School, Pavia, Italy*

ANNEXES

Annex 3A: Detailed design of beams, columns, walls and footings

3A 1. DESIGN OF BEAMS IN BENDING

3A 1.1 FRAME A

```

*-----*
* STOREY: 6 * BEAMS: 1 2 3 4 5
*-----*
* Concrete: C25 - Long. Reinforcement: S500 - Stirrups: S500 - Cover: 35 (mm) *
*-----*
          GEOMETRY - BENDING MOMENTS MED - LONGITUDINAL REINFORCEMENT
+-----+
|Beam:    1|Length l: 5.50m|X-section InvL | Depth h: 0.50m| Width bw: 0.25m |
|-----+-----|
|          |Top flange thickness (m): 0.18 (L end) 0.18 (centre) 0.18 (R end)|
|-----+-----|
| Location |Effect. | max MED | Required | Beam bars | Provided |Flexural|
|          |fl width|          |steel area|Contin Addit|steel area|capacity|
|-----+---(m)---+---(kNm)---+---(mm2)---+---(mm2)---+---(kNm)---|
|L end top | 0.25  |   85.2 |   464.  | 2Φ14   -- |   454.  |   83.4 |
|L end bot. | 0.43  |   40.8 |   287.  | 2Φ14   -- |   308.  |   58.5 |
|midspan   | 1.27  |   37.2 |   287.  | 2Φ14   -- |   308.  |   59.4 |
|R end top  | 0.25  |  112.6 |   627.  | 2Φ14  1Φ12|   607.  |  109.4 |
|R end bot. | 0.61  |   43.6 |   313.  | 2Φ14   -- |   308.  |   58.9 |
|Note: Top reinforcements include 250mm2/m of EC8s eff. slab width in tension |
+-----+
+-----+
|Beam:    2|Length l: 5.30m|X-section InvL | Depth h: 0.50m| Width bw: 0.25m |
|-----+-----|
|          |Top flange thickness (m): 0.18 (L end) 0.18 (centre) 0.18 (R end)|
|-----+-----|
| Location |Effect. | max MED | Required | Beam bars | Provided |Flexural|
|          |fl width|          |steel area|Contin Addit|steel area|capacity|
|-----+---(m)---+---(kNm)---+---(mm2)---+---(mm2)---+---(kNm)---|
|L end top | 0.25  |  124.5 |   700.  | 2Φ14  2Φ12|   720.  |  127.9 |
|L end bot. | 0.61  |   60.1 |   350.  | 2Φ14  1Φ20|   622.  |  117.2 |
|midspan   | 1.09  |   26.8 |   287.  | 2Φ14   -- |   308.  |   59.3 |
|R end top  | 0.25  |  129.1 |   728.  | 2Φ14  1Φ16|   695.  |  123.8 |
|R end bot. | 0.61  |   52.8 |   364.  | 2Φ14  1Φ20|   622.  |  117.2 |
|Note: Top reinforcements include 250mm2/m of EC8s eff. slab width in tension |
+-----+
+-----+

```

```

|Beam:      3|Length l: 5.30m|X-section InvL | Depth h: 0.50m| Width bw: 0.25m |
|-----+-----|
|           |Top flange thickness (m): 0.18 (L end) 0.18 (centre) 0.18 (R end)|
|-----+-----|
| Location |Effect. | max MEd | Required | Beam bars | Provided |Flexural|
|           |fl width|          |steel area|Contin Addit|steel area|capacity|
|-----+---(m)---+---(kNm)---+---(mm2)---+-----+---(mm2)---+---(kNm)---|
|L end top | 0.25  | 125.9  | 708.   | 2Φ14  1Φ16| 695.   | 123.8 |
|L end bot. | 0.61  | 55.9   | 354.   | 2Φ14  1Φ20| 622.   | 117.2 |
|midspan   | 1.09  | 25.4   | 287.   | 2Φ14  -- | 308.   | 59.3  |
|R end top  | 0.25  | 125.9  | 708.   | 2Φ14  1Φ16| 695.   | 123.8 |
|R end bot. | 0.61  | 55.9   | 354.   | 2Φ14  1Φ20| 622.   | 117.2 |
|Note: Top reinforcements include 250mm2/m of EC8s eff. slab width in tension |

```

```

|Beam:      4|Length l: 5.30m|X-section InvL | Depth h: 0.50m| Width bw: 0.25m |
|-----+-----|
|           |Top flange thickness (m): 0.18 (L end) 0.18 (centre) 0.18 (R end)|
|-----+-----|
| Location |Effect. | max MEd | Required | Beam bars | Provided |Flexural|
|           |fl width|          |steel area|Contin Addit|steel area|capacity|
|-----+---(m)---+---(kNm)---+---(mm2)---+-----+---(mm2)---+---(kNm)---|
|L end top | 0.25  | 129.1  | 728.   | 2Φ14  1Φ16| 695.   | 123.8 |
|L end bot. | 0.61  | 52.8   | 364.   | 2Φ14  1Φ20| 622.   | 117.2 |
|midspan   | 1.09  | 26.8   | 287.   | 2Φ14  -- | 308.   | 59.3  |
|R end top  | 0.25  | 124.5  | 700.   | 2Φ14  2Φ12| 720.   | 127.9 |
|R end bot. | 0.61  | 60.1   | 350.   | 2Φ14  1Φ20| 622.   | 117.2 |
|Note: Top reinforcements include 250mm2/m of EC8s eff. slab width in tension |

```

```

|Beam:      5|Length l: 5.50m|X-section InvL | Depth h: 0.50m| Width bw: 0.25m |
|-----+-----|
|           |Top flange thickness (m): 0.18 (L end) 0.18 (centre) 0.18 (R end)|
|-----+-----|
| Location |Effect. | max MEd | Required | Beam bars | Provided |Flexural|
|           |fl width|          |steel area|Contin Addit|steel area|capacity|
|-----+---(m)---+---(kNm)---+---(mm2)---+-----+---(mm2)---+---(kNm)---|
|L end top | 0.25  | 112.6  | 627.   | 2Φ14  1Φ12| 607.   | 109.4 |
|L end bot. | 0.61  | 43.6   | 313.   | 2Φ14  -- | 308.   | 58.9  |
|midspan   | 1.27  | 37.2   | 287.   | 2Φ14  -- | 308.   | 59.4  |
|R end top  | 0.25  | 85.2   | 464.   | 2Φ14  -- | 454.   | 83.4  |
|R end bot. | 0.43  | 40.8   | 287.   | 2Φ14  -- | 308.   | 58.5  |

```

Midspan	20.8	0.321	0.049		17.7	0.041	359.1	0.15		62	307	
R end top	38.0	0.308	0.133		32.2	0.113	249.2	0.10		285	534	
+-----+-----+-----+-----+-----+-----+-----+-----+-----+-----+-----+-----+												
Beam: 5												
+-----+-----+-----+-----+-----+-----+-----+-----+-----+-----+-----+-----+												
Location	Characteristic loads G+Q				Quasi-permanent loads G+ψ2Q				Steel for			
	Moment steel		concrete		Moment concrete		Crack		cracking			
	stress/fyk		stress/fck		stress/fck		spacing width		min provd			
	----- (kNm)		----- (kNm)		----- (kNm)		----- (mm)		----- (mm2) --			
L end top	40.7	0.402	0.172		34.5	0.146	275.4	0.14		291	420	
Midspan	28.9	0.444	0.062		24.5	0.053	359.1	0.20		62	307	
R end top	26.1	0.329	0.120		22.2	0.102	350.1	0.15		253	307	
+-----+-----+-----+-----+-----+-----+-----+-----+-----+-----+-----+-----+												

JOINT GEOMETRY - SHEAR FORCES - VERIFICATION IN SHEAR

Joint	Max Φ		J width		J hor. shear		J hor. shear		J hor. steel		J ver. steel
			bj		Vjh		strength		area Ash		area Asv
	----- (mm)		----- (m)		----- (kN)		----- (kN)		----- (mm2)		----- (mm2)
1	14		0.40		0.		809.		0.		0.
2	30		0.30		0.		1747.		0.		0.
3	30		0.30		0.		1765.		0.		0.
4	30		0.30		0.		1765.		0.		0.
5	30		0.30		0.		1747.		0.		0.
6	14		0.40		0.		809.		0.		0.
+-----+-----+-----+-----+-----+-----+-----+-----+-----+-----+-----+-----+											

* STOREY: 5 * BEAMS: 1 2 3 4 5

* Concrete: C25 - Long. Reinforcement: S500 - Stirrups: S500 - Cover: 35 (mm) *

GEOMETRY - BENDING MOMENTS MED - LONGITUDINAL REINFORCEMENT

Beam: 1	Length l: 5.50m X-section InvL Depth h: 0.50m Width bw: 0.25m										
	+-----+-----+-----+-----+-----+-----+-----+-----+-----+-----+-----+-----+										
	Top flange thickness (m): 0.18 (L end) 0.18 (centre) 0.18 (R end)										
	+-----+-----+-----+-----+-----+-----+-----+-----+-----+-----+-----+-----+										
Location	Effect.		max MEd		Required		Beam bars		Provided		Flexural
	fl width		steel area		Contin Addit		steel area		capacity		
	----- (m)		----- (kNm)		----- (mm2)		----- (mm2)		----- (kNm)		----- (kNm)
L end top	0.25		138.9		789.		2Φ14 2Φ14		762.		134.6

L end bot.	0.43	72.9	395.	2Φ14	1Φ14	462.	86.9
midspan	1.27	32.2	287.	2Φ14	--	308.	59.4
R end top	0.25	149.6	858.	2Φ14	3Φ12	833.	145.8
R end bot.	0.61	89.1	469.	2Φ14	1Φ20	622.	117.2

|Note: Top reinforcements include 250mm²/m of EC8s eff. slab width in tension |

-----+
+-----+
|Beam: 2|Length l: 5.30m|X-section InvL | Depth h: 0.50m| Width bw: 0.25m |

|-----+-----+-----+-----+-----+-----+-----+-----+-----+
| |Top flange thickness (m): 0.18 (L end) 0.18 (centre) 0.18 (R end)|

Location	Effect.	max MEd	Required	Beam bars	Provided	Flexural
fl width			steel area	Contin	Addit	steel area capacity
-----+-- (m) ---+-- (kNm) ---+-- (mm ²) ---+-----+-- (mm ²) ---+-- (kNm) ---						
L end top	0.25	163.9	952.	2Φ14	4Φ12	947. 163.1
L end bot.	0.61	101.8	538.	2Φ14	1Φ20	622. 117.2
midspan	1.09	27.0	287.	2Φ14	--	308. 59.3
R end top	0.25	171.5	1003.	2Φ14	3Φ14	956. 164.5
R end bot.	0.61	93.2	502.	2Φ14	1Φ20	622. 117.2

|Note: Top reinforcements include 250mm²/m of EC8s eff. slab width in tension |

-----+
+-----+
|Beam: 3|Length l: 5.30m|X-section InvL | Depth h: 0.50m| Width bw: 0.25m |

|-----+-----+-----+-----+-----+-----+-----+-----+-----+
| |Top flange thickness (m): 0.18 (L end) 0.18 (centre) 0.18 (R end)|

Location	Effect.	max MEd	Required	Beam bars	Provided	Flexural
fl width			steel area	Contin	Addit	steel area capacity
-----+-- (m) ---+-- (kNm) ---+-- (mm ²) ---+-----+-- (mm ²) ---+-- (kNm) ---						
L end top	0.25	167.8	978.	2Φ14	3Φ14	956. 164.5
L end bot.	0.61	98.4	520.	2Φ14	1Φ20	622. 117.2
midspan	1.09	25.8	287.	2Φ14	--	308. 59.3
R end top	0.25	167.8	978.	2Φ14	3Φ14	956. 164.5
R end bot.	0.61	98.4	520.	2Φ14	1Φ20	622. 117.2

|Note: Top reinforcements include 250mm²/m of EC8s eff. slab width in tension |

-----+
+-----+
|Beam: 4|Length l: 5.30m|X-section InvL | Depth h: 0.50m| Width bw: 0.25m |

|-----+-----+-----+-----+-----+-----+-----+-----+-----+
| |Top flange thickness (m): 0.18 (L end) 0.18 (centre) 0.18 (R end)|

Location	Effect.	max MEd	Required	Beam bars	Provided	Flexural
----------	---------	---------	----------	-----------	----------	----------

	fl width		steel area	Contin Addit	steel area	capacity
	---(m)---	---(kNm)---	---(mm2)---	---	---(mm2)---	---(kNm)---
L end top	0.25	171.5	1003.	2Φ14 3Φ14	956.	164.5
L end bot.	0.61	93.2	502.	2Φ14 1Φ20	622.	117.2
midspan	1.09	27.0	287.	2Φ14 --	308.	59.3
R end top	0.25	163.9	952.	2Φ14 4Φ12	947.	163.1
R end bot.	0.61	101.8	538.	2Φ14 1Φ20	622.	117.2

|Note: Top reinforcements include 250mm²/m of EC8s eff. slab width in tension |

|Beam: 5|Length l: 5.50m|X-section InvL | Depth h: 0.50m| Width bw: 0.25m |

|Top flange thickness (m): 0.18 (L end) 0.18 (centre) 0.18 (R end)|

Location	Effect.	max ME _d	Required	Beam bars	Provided	Flexural
	fl width		steel area	Contin Addit	steel area	capacity
	---(m)---	---(kNm)---	---(mm2)---	---	---(mm2)---	---(kNm)---
L end top	0.25	149.6	858.	2Φ14 3Φ12	833.	145.8
L end bot.	0.61	89.1	469.	2Φ14 1Φ20	622.	117.2
midspan	1.27	32.2	287.	2Φ14 --	308.	59.4
R end top	0.25	138.9	789.	2Φ14 2Φ14	762.	134.6
R end bot.	0.43	72.9	395.	2Φ14 1Φ14	462.	86.9

|Note: Top reinforcements include 250mm²/m of EC8s eff. slab width in tension |

SLS CHECKS: STRESS LIMITS, CRACK WIDTH CONTROL FOR W_{max}=0.3mm & min STEEL AREA

|Beam: 1

Location	Characteristic loads G+Q			Quasi-permanent loads G+ψ ₂ Q			Steel for	
	Moment	steel	concrete	Moment	concrete	Crack	cracking	
	stress/fyk	stress/fck	stress/fck	stress/fck	spacing	width	min provd	
	---(kNm)---	---	---	---(kNm)---	---	---(mm)---	---(mm2)---	
L end top	38.9	0.300	0.142	33.0	0.120	247.4	0.09 253 615	
Midspan	25.1	0.384	0.054	21.3	0.046	359.1	0.18 62 307	
R end top	35.6	0.261	0.120	30.2	0.102	230.3	0.08 282 647	

|Beam: 2

Location	Characteristic loads G+Q			Quasi-permanent loads G+ψ ₂ Q			Steel for	
	Moment	steel	concrete	Moment	concrete	Crack	cracking	
	stress/fyk	stress/fck	stress/fck	stress/fck	spacing	width	min provd	

	-- (kNm) -----			-- (kNm) -----			-- (mm) -----		-- (mm2) --	
L end top	36.6	0.220	0.116	31.0	0.099	215.4	0.06	279	760	
Midspan	21.0	0.323	0.049	17.8	0.042	359.1	0.15	62	307	
R end top	46.1	0.275	0.146	39.1	0.124	221.2	0.08	302	769	

-----+-----+-----+-----+-----+-----+-----+-----+-----+-----+
|Beam: 3 |

Location	Characteristic loads G+Q			Quasi-permanent loads G+ψ2Q			Steel for	
	Moment	steel	concrete	Moment	concrete	Crack	cracking	
	stress/fyk	stress/fck		stress/fck	spacing	width	min provd	

	-- (kNm) -----			-- (kNm) -----			-- (mm) -----		-- (mm2) --	
L end top	40.9	0.244	0.130	34.7	0.110	221.2	0.07	302	769	
Midspan	20.1	0.310	0.047	17.1	0.040	359.1	0.14	62	307	
R end top	40.9	0.244	0.130	34.7	0.110	221.2	0.07	302	769	

-----+-----+-----+-----+-----+-----+-----+-----+-----+-----+
|Beam: 4 |

Location	Characteristic loads G+Q			Quasi-permanent loads G+ψ2Q			Steel for	
	Moment	steel	concrete	Moment	concrete	Crack	cracking	
	stress/fyk	stress/fck		stress/fck	spacing	width	min provd	

	-- (kNm) -----			-- (kNm) -----			-- (mm) -----		-- (mm2) --	
L end top	46.1	0.275	0.146	39.1	0.124	221.2	0.08	302	769	
Midspan	21.0	0.323	0.049	17.8	0.042	359.1	0.15	62	307	
R end top	36.6	0.220	0.116	31.0	0.099	215.4	0.06	279	760	

-----+-----+-----+-----+-----+-----+-----+-----+-----+-----+
|Beam: 5 |

Location	Characteristic loads G+Q			Quasi-permanent loads G+ψ2Q			Steel for	
	Moment	steel	concrete	Moment	concrete	Crack	cracking	
	stress/fyk	stress/fck		stress/fck	spacing	width	min provd	

	-- (kNm) -----			-- (kNm) -----			-- (mm) -----		-- (mm2) --	
L end top	35.6	0.246	0.118	30.2	0.100	229.3	0.07	282	647	
Midspan	25.1	0.384	0.054	21.3	0.046	359.1	0.18	62	307	
R end top	38.9	0.281	0.139	33.0	0.118	246.1	0.09	253	615	

-----+-----+-----+-----+-----+-----+-----+-----+-----+-----+
JOINT GEOMETRY - SHEAR FORCES - VERIFICATION IN SHEAR

Joint	Max Φ	J width	J hor. shear	J hor. shear	J hor. steel	J ver. steel
		bj	Vjh	strength	area Ash	area Asv

	-- (mm) -----	+--- (m) -----	+--- (kN) -----	+--- (kN) -----	+--- (mm2) -----	+--- (mm2) -----
1	14	0.40	0.	768.	0.	0.

2	32	0.30	0.	1635.	0.	0.
3	32	0.30	0.	1673.	0.	0.
4	32	0.30	0.	1673.	0.	0.
5	32	0.30	0.	1635.	0.	0.
6	14	0.40	0.	768.	0.	0.

-----+

* STOREY: 4 * BEAMS: 1 2 3 4 5

* Concrete: C25 - Long. Reinforcement: S500 - Stirrups: S500 - Cover: 35 (mm) *

GEOMETRY - BENDING MOMENTS MED - LONGITUDINAL REINFORCEMENT

-----+

|Beam: 1|Length l: 5.50m|X-section InvL | Depth h: 0.50m| Width bw: 0.25m |

|-----+

| |Top flange thickness (m): 0.18 (L end) 0.18 (centre) 0.18 (R end)|

|-----+

Location	Effect.	max MED	Required	Beam bars	Provided	Flexural
fl width			steel area	Contin Addit	steel area	capacity
-----	-----	-----	-----	-----	-----	-----
(m)	(kNm)	(kNm)	(mm2)		(mm2)	(kNm)
L end top	0.25	140.5	800.	2Φ14 2Φ14	762.	134.6
L end bot.	0.43	79.0	419.	2Φ14 1Φ14	462.	86.9
midspan	1.27	32.8	287.	2Φ14 --	308.	59.4
R end top	0.25	155.9	899.	2Φ14 2Φ16	896.	155.5
R end bot.	0.61	92.7	489.	2Φ14 1Φ20	622.	117.2

|-----+

|Note: Top reinforcements include 250mm2/m of EC8s eff. slab width in tension |

|-----+

|-----+

|Beam: 2|Length l: 5.30m|X-section InvL | Depth h: 0.50m| Width bw: 0.25m |

|-----+

| |Top flange thickness (m): 0.18 (L end) 0.18 (centre) 0.18 (R end)|

|-----+

Location	Effect.	max MED	Required	Beam bars	Provided	Flexural
fl width			steel area	Contin Addit	steel area	capacity
-----	-----	-----	-----	-----	-----	-----
(m)	(kNm)	(kNm)	(mm2)		(mm2)	(kNm)
L end top	0.25	170.4	995.	2Φ14 3Φ16	1097.	193.7
L end bot.	0.61	106.9	566.	2Φ14 1Φ20	622.	117.2
midspan	1.09	26.9	287.	2Φ14 --	308.	59.3
R end top	0.25	176.5	1037.	2Φ14 2Φ18	1003.	177.2
R end bot.	0.61	99.4	525.	2Φ14 1Φ20	622.	117.2

|-----+

|Note: Top reinforcements include 250mm2/m of EC8s eff. slab width in tension |

|-----+

```

+-----+
+-----+
|Beam:      3|Length l: 5.30m|X-section InvL | Depth h: 0.50m| Width bw: 0.25m |
|-----+-----+
|           |Top flange thickness (m): 0.18 (L end) 0.18 (centre) 0.18 (R end)|
|-----+-----+
| Location |Effect. | max MEd | Required | Beam bars | Provided |Flexural|
|           |fl width|          |steel area|Contin Addit|steel area|capacity|
|-----+---(m)---+---(kNm)---+---(mm2)---+---(mm2)---+---(kNm)---|
|L end top | 0.25  | 173.1  | 1014.  | 2Φ14   2Φ18| 1003.  | 177.2 |
|L end bot. | 0.61  | 103.7  | 548.   | 2Φ14   1Φ20| 622.   | 117.2 |
|midspan   | 1.09  | 25.8   | 287.   | 2Φ14   --  | 308.   | 59.3  |
|R end top  | 0.25  | 173.1  | 1014.  | 2Φ14   2Φ18| 1003.  | 177.2 |
|R end bot. | 0.61  | 103.7  | 548.   | 2Φ14   1Φ20| 622.   | 117.2 |
|Note: Top reinforcements include 250mm2/m of EC8s eff. slab width in tension |
+-----+

```

```

+-----+
+-----+
|Beam:      4|Length l: 5.30m|X-section InvL | Depth h: 0.50m| Width bw: 0.25m |
|-----+-----+
|           |Top flange thickness (m): 0.18 (L end) 0.18 (centre) 0.18 (R end)|
|-----+-----+
| Location |Effect. | max MEd | Required | Beam bars | Provided |Flexural|
|           |fl width|          |steel area|Contin Addit|steel area|capacity|
|-----+---(m)---+---(kNm)---+---(mm2)---+---(mm2)---+---(kNm)---|
|L end top | 0.25  | 176.5  | 1037.  | 2Φ14   2Φ18| 1003.  | 177.2 |
|L end bot. | 0.61  | 99.4   | 525.   | 2Φ14   1Φ20| 622.   | 117.2 |
|midspan   | 1.09  | 26.9   | 287.   | 2Φ14   --  | 308.   | 59.3  |
|R end top  | 0.25  | 170.4  | 995.   | 2Φ14   3Φ16| 1097.  | 193.7 |
|R end bot. | 0.61  | 106.9  | 566.   | 2Φ14   1Φ20| 622.   | 117.2 |
|Note: Top reinforcements include 250mm2/m of EC8s eff. slab width in tension |
+-----+

```

```

+-----+
+-----+
|Beam:      5|Length l: 5.50m|X-section InvL | Depth h: 0.50m| Width bw: 0.25m |
|-----+-----+
|           |Top flange thickness (m): 0.18 (L end) 0.18 (centre) 0.18 (R end)|
|-----+-----+
| Location |Effect. | max MEd | Required | Beam bars | Provided |Flexural|
|           |fl width|          |steel area|Contin Addit|steel area|capacity|
|-----+---(m)---+---(kNm)---+---(mm2)---+---(mm2)---+---(kNm)---|
|L end top | 0.25  | 155.9  | 899.   | 2Φ14   2Φ16| 896.   | 155.5 |
|L end bot. | 0.61  | 92.7   | 489.   | 2Φ14   1Φ20| 622.   | 117.2 |
|midspan   | 1.27  | 32.8   | 287.   | 2Φ14   --  | 308.   | 59.4  |
+-----+

```

|R end top | 0.25 | 140.5 | 800. | 2Φ14 2Φ14| 762. | 134.6 |
 |R end bot. | 0.43 | 79.0 | 419. | 2Φ14 1Φ14| 462. | 86.9 |
 |Note: Top reinforcements include 250mm²/m of EC8s eff. slab width in tension |

+-----+
 +-----+
 SLS CHECKS: STRESS LIMITS, CRACK WIDTH CONTROL FOR Wmax=0.3mm & min STEEL AREA

+-----+
 |Beam: 1 |

Location	Characteristic loads G+Q			Quasi-permanent loads G+ψ2Q			Steel for	
	Moment	steel	concrete	Moment	concrete	Crack	cracking	
	stress/fyk stress/fck			stress/fck spacing		width	min provd	
-----+	(kNm)-----+		-----+	(kNm)-----+		-----+	(mm)-----+	
L end top	36.2	0.279	0.132	30.7	0.112	247.4	0.09	253 615
Midspan	25.6	0.392	0.055	21.7	0.047	359.1	0.18	62 307
R end top	37.3	0.252	0.123	31.6	0.104	235.4	0.08	323 709

+-----+
 |Beam: 2 |

Location	Characteristic loads G+Q			Quasi-permanent loads G+ψ2Q			Steel for	
	Moment	steel	concrete	Moment	concrete	Crack	cracking	
	stress/fyk stress/fck			stress/fck spacing		width	min provd	
-----+	(kNm)-----+		-----+	(kNm)-----+		-----+	(mm)-----+	
L end top	37.4	0.193	0.113	31.7	0.096	214.0	0.05	327 911
Midspan	20.9	0.322	0.049	17.7	0.041	359.1	0.15	62 307
R end top	45.4	0.257	0.142	38.5	0.120	227.8	0.07	345 816

+-----+
 |Beam: 3 |

Location	Characteristic loads G+Q			Quasi-permanent loads G+ψ2Q			Steel for	
	Moment	steel	concrete	Moment	concrete	Crack	cracking	
	stress/fyk stress/fck			stress/fck spacing		width	min provd	
-----+	(kNm)-----+		-----+	(kNm)-----+		-----+	(mm)-----+	
L end top	41.0	0.232	0.128	34.7	0.108	227.8	0.07	345 816
Midspan	20.1	0.309	0.047	17.0	0.040	359.1	0.14	62 307
R end top	41.0	0.232	0.128	34.7	0.108	227.8	0.07	345 816

+-----+
 |Beam: 4 |

Location	Characteristic loads G+Q			Quasi-permanent loads G+ψ2Q			Steel for	
	Moment	steel	concrete	Moment	concrete	Crack	cracking	
	stress/fyk stress/fck			stress/fck spacing		width	min provd	

	(m)	(kNm)	(mm ²)	(mm ²)	(kNm)
L end top	0.25	142.9	815.	2Φ14 3Φ12	793. 139.5
L end bot.	0.43	83.1	441.	2Φ14 1Φ14	462. 86.9
midspan	1.27	32.6	287.	2Φ14 --	308. 59.4
R end top	0.25	161.0	933.	2Φ14 2Φ16	896. 155.5
R end bot.	0.61	95.3	503.	2Φ14 1Φ20	622. 117.2

|Note: Top reinforcements include 250mm²/m of EC8s eff. slab width in tension |

|Beam: 2|Length l: 5.30m|X-section InvL | Depth h: 0.50m| Width bw: 0.25m |

|Top flange thickness (m): 0.18 (L end) 0.18 (centre) 0.18 (R end)|

Location	Effect.	max MEd	Required	Beam bars	Provided	Flexural
	fl width		steel area	Contin Addit	steel area	capacity
	(m)	(kNm)	(mm ²)	(mm ²)	(kNm)	

L end top	0.25	175.2	1028.	2Φ14 3Φ16	1097.	193.7
L end bot.	0.61	110.7	586.	2Φ14 1Φ20	622.	117.2
midspan	1.09	26.8	287.	2Φ14 --	308.	59.3
R end top	0.25	180.3	1063.	2Φ14 2Φ18	1003.	177.2
R end bot.	0.61	104.1	551.	2Φ14 1Φ20	622.	117.2

|Note: Top reinforcements include 250mm²/m of EC8s eff. slab width in tension |

|Beam: 3|Length l: 5.30m|X-section InvL | Depth h: 0.50m| Width bw: 0.25m |

|Top flange thickness (m): 0.18 (L end) 0.18 (centre) 0.18 (R end)|

Location	Effect.	max MEd	Required	Beam bars	Provided	Flexural
	fl width		steel area	Contin Addit	steel area	capacity
	(m)	(kNm)	(mm ²)	(mm ²)	(kNm)	

L end top	0.25	177.2	1042.	2Φ14 2Φ18	1003.	177.2
L end bot.	0.61	107.8	571.	2Φ14 1Φ20	622.	117.2
midspan	1.09	25.8	287.	2Φ14 --	308.	59.3
R end top	0.25	177.2	1042.	2Φ14 2Φ18	1003.	177.2
R end bot.	0.61	107.8	571.	2Φ14 1Φ20	622.	117.2

|Note: Top reinforcements include 250mm²/m of EC8s eff. slab width in tension |

|Beam: 4|Length l: 5.30m|X-section InvL | Depth h: 0.50m| Width bw: 0.25m |

|Top flange thickness (m): 0.18 (L end) 0.18 (centre) 0.18 (R end)|

Location	Effect.	max MEd	Required	Beam bars	Provided	Flexural
fl width			steel area	Contin Addit	steel area	capacity
--- (m) ---	--- (kNm) ---	--- (mm2) ---	--- (mm2) ---	--- (kNm) ---		
L end top	0.25	180.3	1063.	2Φ14 2Φ18	1003.	177.2
L end bot.	0.61	104.1	551.	2Φ14 1Φ20	622.	117.2
midspan	1.09	26.8	287.	2Φ14 --	308.	59.3
R end top	0.25	175.2	1028.	2Φ14 3Φ16	1097.	193.7
R end bot.	0.61	110.7	586.	2Φ14 1Φ20	622.	117.2

Note: Top reinforcements include 250mm²/m of EC8s eff. slab width in tension

Beam: 5 | Length l: 5.50m | X-section InvL | Depth h: 0.50m | Width bw: 0.25m

Top flange thickness (m): 0.18 (L end) 0.18 (centre) 0.18 (R end)

Location	Effect.	max MEd	Required	Beam bars	Provided	Flexural
fl width			steel area	Contin Addit	steel area	capacity
--- (m) ---	--- (kNm) ---	--- (mm2) ---	--- (mm2) ---	--- (kNm) ---		
L end top	0.25	161.0	933.	2Φ14 2Φ16	896.	155.5
L end bot.	0.61	95.3	503.	2Φ14 1Φ20	622.	117.2
midspan	1.27	32.6	287.	2Φ14 --	308.	59.4
R end top	0.25	142.9	815.	2Φ14 3Φ12	793.	139.5
R end bot.	0.43	83.1	441.	2Φ14 1Φ14	462.	86.9

Note: Top reinforcements include 250mm²/m of EC8s eff. slab width in tension

SLS CHECKS: STRESS LIMITS, CRACK WIDTH CONTROL FOR Wmax=0.3mm & min STEEL AREA

Beam: 1

Location	Characteristic loads G+Q	Quasi-permanent loads G+ψ2Q	Steel for						
Moment	steel	concrete	Moment concrete						
stress/fyk	stress/fck	stress/fck	Crack spacing width						
--- (kNm) ---	--- (kNm) ---	--- (kNm) ---	--- (mm) ---						
L end top	35.2	0.259	0.127	29.9	0.107	234.2	0.08	237	647
Midspan	25.4	0.389	0.055	21.5	0.046	359.1	0.18	62	307
R end top	38.7	0.261	0.127	32.8	0.108	235.4	0.08	323	709

Beam: 2

Location | Characteristic loads G+Q | Quasi-permanent loads G+ψ2Q | Steel for

	Moment	steel	concrete	Moment	concrete	Crack	cracking	
	stress/fyk	stress/fck		stress/fck	spacing	width	min provd	
	(kNm)			(kNm)	(mm)		(mm2) --	
L end top	38.0	0.196	0.115	32.2	0.098	214.0	0.05	327 911
Midspan	20.9	0.321	0.049	17.7	0.041	359.1	0.15	62 307
R end top	44.9	0.254	0.140	38.1	0.119	227.8	0.07	345 816

|Beam: 3 |

Location	Characteristic loads G+Q			Quasi-permanent loads G+ψ2Q			Steel for	
	Moment	steel	concrete	Moment	concrete	Crack	cracking	
	stress/fyk	stress/fck		stress/fck	spacing	width	min provd	
	(kNm)			(kNm)	(mm)		(mm2) --	
L end top	40.9	0.232	0.128	34.7	0.108	227.8	0.07	345 816
Midspan	20.1	0.310	0.047	17.1	0.040	359.1	0.14	62 307
R end top	40.9	0.232	0.128	34.7	0.108	227.8	0.07	345 816

|Beam: 4 |

Location	Characteristic loads G+Q			Quasi-permanent loads G+ψ2Q			Steel for	
	Moment	steel	concrete	Moment	concrete	Crack	cracking	
	stress/fyk	stress/fck		stress/fck	spacing	width	min provd	
	(kNm)			(kNm)	(mm)		(mm2) --	
L end top	44.9	0.254	0.140	38.1	0.119	227.8	0.07	345 816
Midspan	20.9	0.321	0.049	17.7	0.041	359.1	0.15	62 307
R end top	38.0	0.196	0.115	32.2	0.098	214.0	0.05	327 911

|Beam: 5 |

Location	Characteristic loads G+Q			Quasi-permanent loads G+ψ2Q			Steel for	
	Moment	steel	concrete	Moment	concrete	Crack	cracking	
	stress/fyk	stress/fck		stress/fck	spacing	width	min provd	
	(kNm)			(kNm)	(mm)		(mm2) --	
L end top	38.7	0.247	0.125	32.8	0.106	234.3	0.07	323 709
Midspan	25.4	0.389	0.055	21.5	0.046	359.1	0.18	62 307
R end top	35.2	0.244	0.124	29.9	0.105	233.1	0.07	237 647

JOINT GEOMETRY - SHEAR FORCES - VERIFICATION IN SHEAR

Joint	Max Φ	J width	J hor. shear	J hor. shear	J hor. steel	J ver. steel
		bj	Vjh	strength	area Ash	area Asv

	(mm)	(m)	(kN)	(kN)	(mm ²)	(mm ²)
1	14	0.40	0.	679.	0.	0.
2	34	0.30	0.	1386.	0.	0.
3	34	0.30	0.	1473.	0.	0.
4	34	0.30	0.	1473.	0.	0.
5	34	0.30	0.	1386.	0.	0.
6	14	0.40	0.	679.	0.	0.

-----*

* STOREY: 2 * BEAMS: 1 2 3 4 5

-----*

* Concrete: C25 - Long. Reinforcement: S500 - Stirrups: S500 - Cover: 35 (mm) *

-----*

GEOMETRY - BENDING MOMENTS MED - LONGITUDINAL REINFORCEMENT

Beam: 1 Length l: 5.50m X-section InvL Depth h: 0.50m Width bw: 0.25m							
Top flange thickness (m): 0.18 (L end) 0.18 (centre) 0.18 (R end)							
Location	Effect.	max MEd	Required	Beam bars	Provided	Flexural	
	fl width		steel area	Contin Addit	steel area	capacity	
	(m)	(kNm)	(mm ²)		(mm ²)	(kNm)	
L end top	0.25	138.1	785.	2Φ14 2Φ14	762.	134.6	
L end bot.	0.43	80.2	426.	2Φ14 1Φ14	462.	86.9	
midspan	1.27	32.1	287.	2Φ14 --	308.	59.4	
R end top	0.25	157.5	910.	2Φ14 2Φ16	896.	155.5	
R end bot.	0.61	88.7	467.	2Φ14 1Φ20	622.	117.2	
Note: Top reinforcements include 250mm ² /m of EC8s eff. slab width in tension							

Beam: 2 Length l: 5.30m X-section InvL Depth h: 0.50m Width bw: 0.25m							
Top flange thickness (m): 0.18 (L end) 0.18 (centre) 0.18 (R end)							
Location	Effect.	max MEd	Required	Beam bars	Provided	Flexural	
	fl width		steel area	Contin Addit	steel area	capacity	
	(m)	(kNm)	(mm ²)		(mm ²)	(kNm)	
L end top	0.25	169.7	991.	2Φ14 3Φ16	1097.	193.7	
L end bot.	0.61	103.8	549.	2Φ14 1Φ20	622.	117.2	
midspan	1.09	26.8	287.	2Φ14 --	308.	59.3	
R end top	0.25	173.6	1018.	2Φ14 2Φ18	1003.	177.2	

```

|R end bot. | 0.61 | 98.7 | 521. | 2Φ14 1Φ20| 622. | 117.2 |
|Note: Top reinforcements include 250mm2/m of EC8s eff. slab width in tension |
+-----+
+-----+
|Beam: 3|Length l: 5.30m|X-section InvL | Depth h: 0.50m| Width bw: 0.25m |
|-----+-----|
| |Top flange thickness (m): 0.18 (L end) 0.18 (centre) 0.18 (R end)|
|-----+-----|
| Location |Effect. | max MEd | Required | Beam bars | Provided |Flexural|
| |fl width| |steel area |Contin Addit |steel area|capacity|
|-----+---(m)---+---(kNm)---+---(mm2)---+-----+---(mm2)---+---(kNm)---|
|L end top | 0.25 | 171.1 | 1000. | 2Φ14 2Φ18| 1003. | 177.2 |
|L end bot. | 0.61 | 101.7 | 538. | 2Φ14 1Φ20| 622. | 117.2 |
|midspan | 1.09 | 25.9 | 287. | 2Φ14 -- | 308. | 59.3 |
|R end top | 0.25 | 171.1 | 1000. | 2Φ14 2Φ18| 1003. | 177.2 |
|R end bot. | 0.61 | 101.7 | 538. | 2Φ14 1Φ20| 622. | 117.2 |
|Note: Top reinforcements include 250mm2/m of EC8s eff. slab width in tension |
+-----+
+-----+
|Beam: 4|Length l: 5.30m|X-section InvL | Depth h: 0.50m| Width bw: 0.25m |
|-----+-----|
| |Top flange thickness (m): 0.18 (L end) 0.18 (centre) 0.18 (R end)|
|-----+-----|
| Location |Effect. | max MEd | Required | Beam bars | Provided |Flexural|
| |fl width| |steel area |Contin Addit |steel area|capacity|
|-----+---(m)---+---(kNm)---+---(mm2)---+-----+---(mm2)---+---(kNm)---|
|L end top | 0.25 | 173.6 | 1018. | 2Φ14 2Φ18| 1003. | 177.2 |
|L end bot. | 0.61 | 98.7 | 521. | 2Φ14 1Φ20| 622. | 117.2 |
|midspan | 1.09 | 26.8 | 287. | 2Φ14 -- | 308. | 59.3 |
|R end top | 0.25 | 169.7 | 991. | 2Φ14 3Φ16| 1097. | 193.7 |
|R end bot. | 0.61 | 103.8 | 549. | 2Φ14 1Φ20| 622. | 117.2 |
|Note: Top reinforcements include 250mm2/m of EC8s eff. slab width in tension |
+-----+
+-----+
|Beam: 5|Length l: 5.50m|X-section InvL | Depth h: 0.50m| Width bw: 0.25m |
|-----+-----|
| |Top flange thickness (m): 0.18 (L end) 0.18 (centre) 0.18 (R end)|
|-----+-----|
| Location |Effect. | max MEd | Required | Beam bars | Provided |Flexural|
| |fl width| |steel area |Contin Addit |steel area|capacity|
|-----+---(m)---+---(kNm)---+---(mm2)---+-----+---(mm2)---+---(kNm)---|
|L end top | 0.25 | 157.5 | 910. | 2Φ14 2Φ16| 896. | 155.5 |

```

	Moment steel	concrete	Moment concrete	Crack	cracking
	stress/fyk	stress/fck	stress/fck	spacing	width
	(kNm)		(kNm)	(mm)	(mm ²)
L end top	44.1	0.250	0.138	37.4	0.117
Midspan	20.9	0.321	0.049	17.7	0.041
R end top	38.8	0.200	0.118	32.9	0.100

Beam: 5

Location	Characteristic loads G+Q	Quasi-permanent loads G+ψ2Q	Steel for		
	Moment steel	concrete	cracking		
	stress/fyk	stress/fck	stress/fck		
	(kNm)		(kNm)		
			spacing		
			width		
			(mm)		
			(mm ²)		
L end top	40.5	0.259	0.131	34.4	0.111
Midspan	25.0	0.384	0.054	21.2	0.046
R end top	34.1	0.247	0.122	28.9	0.103

JOINT GEOMETRY - SHEAR FORCES - VERIFICATION IN SHEAR

Joint	Max Φ	J width	J hor. shear	J hor. shear	J hor. steel	J ver. steel
		b _j	V _{jh}	strength	area A _{sh}	area A _{sv}
	(mm)	(m)	(kN)	(kN)	(mm ²)	(mm ²)
1	14	0.40	0.	633.	0.	0.
2	36	0.30	0.	1244.	0.	0.
3	34	0.30	0.	1365.	0.	0.
4	34	0.30	0.	1365.	0.	0.
5	36	0.30	0.	1244.	0.	0.
6	14	0.40	0.	633.	0.	0.

* STOREY: 1 * BEAMS: 1 2 3 4 5

* Concrete: C25 - Long. Reinforcement: S500 - Stirrups: S500 - Cover: 35 (mm) *

GEOMETRY - BENDING MOMENTS MED - LONGITUDINAL REINFORCEMENT

Beam: 1 | Length l: 5.50m | X-section InvL | Depth h: 0.50m | Width bw: 0.25m |

|-----|

| Top flange thickness (m): 0.18 (L end) 0.18 (centre) 0.18 (R end) |

|-----|

Location	Effect.	max MEd	Required	Beam bars	Provided	Flexural
fl width			steel area	Contin Addit	steel area	capacity
(m)	(kNm)	(mm2)	(mm2)		(mm2)	(kNm)
L end top	0.25	116.5	650.	2Φ14 2Φ12	856.	149.3
L end bot.	0.43	68.6	362.	2Φ14 1Φ14	462.	86.9
midspan	1.27	33.3	287.	2Φ14 --	308.	59.4
R end top	0.25	146.4	837.	2Φ14 1Φ20	808.	141.9
R end bot.	0.61	70.7	419.	2Φ14 1Φ20	622.	117.2

Note: Top reinforcements include 250mm²/m of EC8s eff. slab width in tension

Beam: 2 | Length l: 5.30m | X-section InvL | Depth h: 0.50m | Width bw: 0.25m

Top flange thickness (m): 0.18 (L end) 0.18 (centre) 0.18 (R end)

Location	Effect.	max MEd	Required	Beam bars	Provided	Flexural
fl width			steel area	Contin Addit	steel area	capacity
(m)	(kNm)	(mm2)	(mm2)		(mm2)	(kNm)
L end top	0.25	157.8	912.	2Φ14 1Φ20	808.	141.9
L end bot.	0.61	89.3	470.	2Φ14 1Φ20	622.	117.2
midspan	1.09	26.6	287.	2Φ14 --	308.	59.3
R end top	0.25	159.0	920.	2Φ14 2Φ16	896.	155.5
R end bot.	0.61	86.3	460.	2Φ14 1Φ20	622.	117.2

Note: Top reinforcements include 250mm²/m of EC8s eff. slab width in tension

Beam: 3 | Length l: 5.30m | X-section InvL | Depth h: 0.50m | Width bw: 0.25m

Top flange thickness (m): 0.18 (L end) 0.18 (centre) 0.18 (R end)

Location	Effect.	max MEd	Required	Beam bars	Provided	Flexural
fl width			steel area	Contin Addit	steel area	capacity
(m)	(kNm)	(mm2)	(mm2)		(mm2)	(kNm)
L end top	0.25	156.9	906.	2Φ14 2Φ16	896.	155.5
L end bot.	0.61	87.7	461.	2Φ14 1Φ20	622.	117.2
midspan	1.09	25.9	287.	2Φ14 --	308.	59.3
R end top	0.25	156.9	906.	2Φ14 2Φ16	896.	155.5
R end bot.	0.61	87.7	461.	2Φ14 1Φ20	622.	117.2

Note: Top reinforcements include 250mm²/m of EC8s eff. slab width in tension

Beam: 4 | Length l: 5.30m | X-section InvL | Depth h: 0.50m | Width bw: 0.25m

-----+-----							
Top flange thickness (m): 0.18 (L end) 0.18 (centre) 0.18 (R end)							
-----+-----							
Location	Effect.	max MEd	Required	Beam bars	Provided	Flexural	
fl width			steel area	Contin Addit	steel area	capacity	
-----+-- (m) ---+-- (kNm) ---+-- (mm2) ---+-----+-- (mm2) ---+-- (kNm) ---							
L end top	0.25	159.0	920.	2Φ14 2Φ16	896.	155.5	
L end bot.	0.61	86.3	460.	2Φ14 1Φ20	622.	117.2	
midspan	1.09	26.6	287.	2Φ14 --	308.	59.3	
R end top	0.25	157.8	912.	2Φ14 1Φ20	808.	141.9	
R end bot.	0.61	89.3	470.	2Φ14 1Φ20	622.	117.2	
Note: Top reinforcements include 250mm ² /m of EC8s eff. slab width in tension							
+-----+-----							
Beam: 5 Length l: 5.50m X-section InvL Depth h: 0.50m Width bw: 0.25m							
-----+-----							
Top flange thickness (m): 0.18 (L end) 0.18 (centre) 0.18 (R end)							
-----+-----							
Location	Effect.	max MEd	Required	Beam bars	Provided	Flexural	
fl width			steel area	Contin Addit	steel area	capacity	
-----+-- (m) ---+-- (kNm) ---+-- (mm2) ---+-----+-- (mm2) ---+-- (kNm) ---							
L end top	0.25	146.4	837.	2Φ14 1Φ20	808.	141.9	
L end bot.	0.61	70.7	419.	2Φ14 1Φ20	622.	117.2	
midspan	1.27	33.3	287.	2Φ14 --	308.	59.4	
R end top	0.25	116.5	650.	2Φ14 2Φ12	856.	149.3	
R end bot.	0.43	68.6	362.	2Φ14 1Φ14	462.	86.9	
Note: Top reinforcements include 250mm ² /m of EC8s eff. slab width in tension							
+-----+-----							
+-----+-----							
SLS CHECKS: STRESS LIMITS, CRACK WIDTH CONTROL FOR W _{max} =0.3mm & min STEEL AREA							
+-----+-----+-----+-----+-----+-----+-----+-----							
Beam: 1							
+-----+-----+-----+-----+-----+-----+-----+-----							
Location	Characteristic loads G+Q	Quasi-permanent loads G+ψ ₂ Q	Steel for				
Moment	steel	concrete	Moment concrete	Crack	cracking		
stress/fyk	stress/fck	stress/fck	spacing	width	min provd		
-----+-- (kNm) -----+-- (kNm) -----+-- (mm) -----+-- (mm2) ---							
L end top	28.2	0.191	0.099	23.9	0.084	253.2	0.06 299 709
Midspan	25.9	0.398	0.056	22.0	0.047	359.1	0.18 62 307
R end top	44.6	0.339	0.152	37.8	0.129	258.7	0.11 348 622
+-----+-----+-----+-----+-----+-----+-----+-----							
Beam: 2							

Location	Characteristic loads G+Q			Quasi-permanent loads G+ψ2Q				Steel for		
	Moment	steel	concrete	Moment	concrete	Crack	cracking			
	stress/fyk	stress/fck		stress/fck	spacing	width	min provd			
	(kNm)			(kNm)				(mm)		
L end top	40.4	0.288	0.135	34.3	0.115	257.2	0.09	348	622	
Midspan	20.7	0.319	0.048	17.6	0.041	359.1	0.15	62	307	
R end top	42.9	0.274	0.139	36.4	0.118	234.3	0.08	323	709	

|Beam: 3

Location	Characteristic loads G+Q			Quasi-permanent loads G+ψ2Q				Steel for		
	Moment	steel	concrete	Moment	concrete	Crack	cracking			
	stress/fyk	stress/fck		stress/fck	spacing	width	min provd			
	(kNm)			(kNm)				(mm)		
L end top	40.8	0.261	0.132	34.6	0.112	234.3	0.08	323	709	
Midspan	20.2	0.311	0.047	17.1	0.040	359.1	0.14	62	307	
R end top	40.8	0.261	0.132	34.6	0.112	234.3	0.08	323	709	

|Beam: 4

Location	Characteristic loads G+Q			Quasi-permanent loads G+ψ2Q				Steel for		
	Moment	steel	concrete	Moment	concrete	Crack	cracking			
	stress/fyk	stress/fck		stress/fck	spacing	width	min provd			
	(kNm)			(kNm)				(mm)		
L end top	42.9	0.274	0.139	36.4	0.118	234.3	0.08	323	709	
Midspan	20.7	0.319	0.048	17.6	0.041	359.1	0.15	62	307	
R end top	40.4	0.288	0.135	34.3	0.115	257.2	0.09	348	622	

|Beam: 5

Location	Characteristic loads G+Q			Quasi-permanent loads G+ψ2Q				Steel for		
	Moment	steel	concrete	Moment	concrete	Crack	cracking			
	stress/fyk	stress/fck		stress/fck	spacing	width	min provd			
	(kNm)			(kNm)				(mm)		
L end top	44.6	0.318	0.149	37.8	0.127	257.2	0.10	348	622	
Midspan	25.9	0.398	0.056	22.0	0.047	359.1	0.18	62	307	
R end top	28.2	0.181	0.097	23.9	0.082	251.9	0.06	299	709	

JOINT GEOMETRY - SHEAR FORCES - VERIFICATION IN SHEAR

Joint	Max Φ	J width	J hor. shear	J hor. shear	J hor. steel	J ver. steel
		b_j	V_{jh}	strength	area A_{sh}	area A_{sv}
+	+	+	+	+	+	+
-----	-----	-----	-----	-----	-----	-----
(mm)	(mm)	(m)	(kN)	(kN)	(mm ²)	(mm ²)
1	14	0.40	0.	590.	0.	0.
2	36	0.30	0.	1092.	0.	0.
3	36	0.30	0.	1254.	0.	0.
4	36	0.30	0.	1254.	0.	0.
5	36	0.30	0.	1092.	0.	0.
6	14	0.40	0.	590.	0.	0.

3A 1.2 FRAME B

```

*-----*
* STOREY: 6 * BEAMS: 6 7
*-----*
* Concrete: C25 - Long. Reinforcement: S500 - Stirrups: S500 - Cover: 35(mm) *
*-----*
          GEOMETRY - BENDING MOMENTS MED - LONGITUDINAL REINFORCEMENT
+-----+
|Beam: 6|Length l: 5.60m|X-section T | Depth h: 0.50m| Width bw: 0.25m |
|-----+-----|
|          |Top flange thickness (m): 0.18 (L end) 0.18 (centre) 0.18 (R end)|
|-----+-----|
| Location |Effect. | max MED | Required | Beam bars | Provided |Flexural|
|          |fl width|          | steel area| Contin Addit | steel area|capacity|
|-----+---(m)---+---(kNm)---+---(mm2)---+-----+---(mm2)---+---(kNm)---|
|L end top | 0.25 | 206.6 | 1251. | 2 $\Phi$ 14 5 $\Phi$ 12| 1241. | 217.9 |
|L end bot. | 0.61 | 7.1 | 625. | 2 $\Phi$ 14 2 $\Phi$ 14| 616. | 116.0 |
|midspan | 2.29 | 60.4 | 312. | 2 $\Phi$ 14 1 $\Phi$ 14| 462. | 89.2 |
|R end top | 0.25 | 117.7 | 709. | 2 $\Phi$ 14 -- | 730. | 129.5 |
|R end bot. | 0.97 | 53.8 | 355. | 2 $\Phi$ 14 -- | 462. | 88.5 |
|Note: Top reinforcements include 250mm2/m of EC8s eff. slab width in tension |
+-----+
+-----+
|Beam: 7|Length l: 5.50m|X-section T | Depth h: 0.50m| Width bw: 0.25m |
|-----+-----|
|          |Top flange thickness (m): 0.18 (L end) 0.18 (centre) 0.18 (R end)|
|-----+-----|
| Location |Effect. | max MED | Required | Beam bars | Provided |Flexural|

```

	fl width		steel area	Contin	Addit	steel area	capacity
	(m)	(kNm)	(mm ²)			(mm ²)	(kNm)
L end top	0.25	127.5	718.	2Φ14	--	730.	129.5
L end bot.	0.97	22.9	359.	2Φ14	--	462.	88.5
midspan	2.29	69.1	357.	2Φ14	1Φ14	462.	89.2
R end top	0.25	157.8	912.	2Φ14	3Φ12	890.	154.4
R end bot.	0.61	22.0	456.	2Φ14	--	462.	87.7

Note: Top reinforcements include 250mm²/m of EC8s eff. slab width in tension |
Note:1. Addit. bot. midspan bars extended: 1Φ14 to L end - 1Φ14 to R end |
2. Addit. bot. midspan bars extended to Right end of beam 1: 1Φ14 |

SLS CHECKS: STRESS LIMITS, CRACK WIDTH CONTROL FOR Wmax=0.3mm & min STEEL AREA

Location	Characteristic loads G+Q	Quasi-permanent loads G+ψ2Q	Steel for
	Moment steel	Moment concrete	cracking
	stress/fyk	stress/fck	Crack spacing width
	(kNm)	(kNm)	(mm)
L end top	117.5	99.7	205.0
Midspan	47.0	39.9	296.6
R end top	37.8	32.0	296.0

Location	Characteristic loads G+Q	Quasi-permanent loads G+ψ2Q	Steel for
	Moment steel	Moment concrete	cracking
	stress/fyk	stress/fck	Crack spacing width
	(kNm)	(kNm)	(mm)
L end top	61.7	52.3	291.2
Midspan	53.7	45.6	296.6
R end top	80.1	67.9	225.8

JOINT GEOMETRY - SHEAR FORCES - VERIFICATION IN SHEAR

Joint	Max Φ	J width	J hor. shear	J hor. shear	J hor. steel	J ver. steel
		bj	Vjh	strength	area Ash	area Asv
	(mm)	(m)	(kN)	(kN)	(mm ²)	(mm ²)
1	14	0.40	0.	800.	0.	0.
2	22	0.50	0.	2013.	0.	0.

```
| 3| 22 | 0.50 | 0. | 1654. | 0. | 0. |
+-----+-----+-----+-----+-----+-----+-----+
```

```
*-----*
* STOREY: 5 * BEAMS: 6 7
*-----*
* Concrete: C25 - Long. Reinforcement: S500 - Stirrups: S500 - Cover: 35 (mm) *
*-----*
```

GEOMETRY - BENDING MOMENTS MED - LONGITUDINAL REINFORCEMENT

```
+-----+
|Beam: 6|Length l: 5.60m|X-section T | Depth h: 0.50m| Width bw: 0.25m |
|-----+-----+-----+-----+-----+-----+-----+
| |Top flange thickness (m): 0.18 (L end) 0.18 (centre) 0.18 (R end)|
|-----+-----+-----+-----+-----+-----+-----+
| Location |Effect. | max MED | Required | Beam bars | Provided |Flexural|
| |fl width| |steel area |Contin Addit |steel area|capacity|
|-----+--- (m) ---+--- (kNm) ---+--- (mm2) ---+-----+--- (mm2) ---+--- (kNm) ---|
|L end top | 0.25 | 266.6 | 1731. | 2Φ14 9Φ12| 1693. | 294.0 |
|L end bot. | 0.61 | 29.4 | 866. | 2Φ14 4Φ14| 924. | 171.4 |
|midspan | 2.29 | 55.1 | 287. | 2Φ14 -- | 308. | 59.6 |
|R end top | 0.25 | 152.4 | 876. | 2Φ14 1Φ14| 884. | 153.6 |
|R end bot. | 0.97 | 112.3 | 589. | 2Φ14 1Φ20| 622. | 118.6 |
|Note: Top reinforcements include 250mm2/m of EC8s eff. slab width in tension |
+-----+
+-----+
```

```
|Beam: 7|Length l: 5.50m|X-section T | Depth h: 0.50m| Width bw: 0.
25m |
|-----+-----+-----+-----+-----+-----+-----+
| |Top flange thickness (m): 0.18 (L end) 0.18 (centre) 0.18 (R end)|
|-----+-----+-----+-----+-----+-----+-----+
| Location |Effect. | max MED | Required | Beam bars | Provided |Flexural|
| |fl width| |steel area |Contin Addit |steel area|capacity|
|-----+--- (m) ---+--- (kNm) ---+--- (mm2) ---+-----+--- (mm2) ---+--- (kNm) ---|
|L end top | 0.25 | 171.4 | 1002. | 2Φ14 2Φ14| 1038. | 183.4 |
|L end bot. | 0.97 | 75.3 | 501. | 2Φ14 1Φ20| 622. | 118.6 |
|midspan | 2.29 | 59.9 | 309. | 2Φ14 1Φ14| 462. | 89.2 |
|R end top | 0.25 | 218.6 | 1340. | 2Φ14 3Φ18| 1314. | 230.4 |
|R end bot. | 0.61 | 49.9 | 670. | 2Φ14 2Φ20| 936. | 173.6 |
|Note: Top reinforcements include 250mm2/m of EC8s eff. slab width in tension |
+-----+
+-----+
```

SLS CHECKS: STRESS LIMITS, CRACK WIDTH CONTROL FOR Wmax=0.3mm & min STEEL AREA

+-----+-----+-----+-----+-----+									
Beam: 6									
+-----+-----+-----+-----+-----+									
Location	Characteristic loads G+Q			Quasi-permanent loads G+ψ2Q			Steel for		
	Moment	steel	concrete	Moment	concrete	Crack	cracking		
	stress/fyk		stress/fck	stress/fck		spacing	width	min provd	
	-(kNm)			-(kNm)			-(mm)		-(mm2)--
L end top	139.7	0.512	0.348	118.6	0.295	183.3	0.12	92	1325
Midspan	42.9	0.647	0.069	36.4	0.059	359.1	0.30	62	307
R end top	23.7	0.216	0.086	20.0	0.073	255.8	0.07	222	461

+-----+-----+-----+-----+-----+									
Beam: 7									
+-----+-----+-----+-----+-----+									
Location	Characteristic loads G+Q			Quasi-permanent loads G+ψ2Q			Steel for		
	Moment	steel	concrete	Moment	concrete	Crack	cracking		
	stress/fyk		stress/fck	stress/fck		spacing	width	min provd	
	-(kNm)			-(kNm)			-(mm)		-(mm2)--
L end top	56.6	0.363	0.184	48.0	0.156	228.6	0.11	222	615
Midspan	46.6	0.474	0.061	39.5	0.052	296.6	0.18	62	461
R end top	99.4	0.410	0.254	84.3	0.216	208.8	0.11	293	1071

JOINT GEOMETRY - SHEAR FORCES - VERIFICATION IN SHEAR

+-----+-----+-----+-----+-----+									
Joint	Max Φ	J width	J hor. shear	J hor. shear	J hor. steel	J ver. steel			
		bj	Vjh	strength	area Ash	area Asv			
	(mm)	(m)	(kN)	(kN)	(mm2)	(mm2)			
1	14	0.40	0.	739.	0.	0.			
2	24	0.50	0.	1824.	0.	0.			
3	22	0.50	0.	1538.	0.	0.			

* STOREY: 4 * BEAMS: 6 7

* Concrete: C25 - Long. Reinforcement: S500 - Stirrups: S500 - Cover: 35 (mm) *

GEOMETRY - BENDING MOMENTS MED - LONGITUDINAL REINFORCEMENT

+-----+-----+-----+-----+-----+									
Beam: 6 Length l: 5.60m X-section T Depth h: 0.50m Width bw: 0.25m									
+-----+-----+-----+-----+-----+									
Top flange thickness (m): 0.18 (L end) 0.18 (centre) 0.18 (R end)									

Location	Effect.	max MEd	Required	Beam bars	Provided	Flexural
fl width			steel area	Contin Addit	steel area	capacity
--- (m) ---	--- (kNm) ---	--- (mm2) ---	--- (mm2) ---	--- (kNm) ---		
L end top	0.25	266.1	1727.	2Φ14 9Φ12	1693.	294.0
L end bot.	0.61	42.8	864.	2Φ14 4Φ14	924.	171.4
midspan	2.29	56.4	291.	2Φ14 1Φ14	462.	89.2
R end top	0.25	162.4	942.	2Φ14 1Φ16	931.	160.8
R end bot.	0.97	111.7	585.	2Φ14 1Φ20	622.	118.6

|Note: Top reinforcements include 250mm²/m of EC8s eff. slab width in tension |

|Beam: 7|Length l: 5.50m|X-section T | Depth h: 0.50m| Width bw: 0.25m |

|Top flange thickness (m): 0.18 (L end) 0.18 (centre) 0.18 (R end)|

Location	Effect.	max MEd	Required	Beam bars	Provided	Flexural
fl width			steel area	Contin Addit	steel area	capacity
--- (m) ---	--- (kNm) ---	--- (mm2) ---	--- (mm2) ---	--- (kNm) ---		
L end top	0.25	178.3	1049.	2Φ14 2Φ16	1132.	199.7
L end bot.	0.97	77.0	525.	2Φ14 1Φ20	622.	118.6
midspan	2.29	61.4	317.	2Φ14 1Φ14	462.	89.2
R end top	0.25	219.6	1348.	2Φ14 3Φ18	1314.	230.4
R end bot.	0.61	60.1	674.	2Φ14 2Φ20	936.	173.6

|Note: Top reinforcements include 250mm²/m of EC8s eff. slab width in tension |

SLS CHECKS: STRESS LIMITS, CRACK WIDTH CONTROL FOR Wmax=0.3mm & min STEEL AREA

|Beam: 6

Location	Characteristic loads G+Q	Quasi-permanent loads G+ψ2Q	Steel for
Moment steel concrete	Moment concrete	Crack	cracking
stress/fyk stress/fck	stress/fck	spacing width	min provd
--- (kNm) ---	--- (kNm) ---	--- (mm) ---	--- (mm2) ---
L end top	131.5 0.482 0.328	111.7 0.278	183.3 0.11 92 1325
Midspan	43.9 0.446 0.058	37.2 0.049	296.6 0.17 62 461
R end top	30.0 0.253 0.106	25.3 0.090	252.1 0.08 241 508

|Beam: 7

|Location | Characteristic loads G+Q | Quasi-permanent loads G+ψ2Q |Steel for|

	Moment steel	concrete	Moment concrete	Crack	cracking
	stress/fyk	stress/fck	stress/fck	spacing	width min provd
	(kNm)		(kNm)	(mm)	(mm2)
L end top	59.7	0.344	0.187	50.6	0.159 223.6 0.10 250 709
Midspan	47.8	0.486	0.063	40.5	0.053 296.6 0.18 62 461
R end top	94.0	0.388	0.241	79.8	0.204 208.8 0.10 293 1071

JOINT GEOMETRY - SHEAR FORCES - VERIFICATION IN SHEAR

Joint	Max Φ	J width	J hor. shear	J hor. shear	J hor. steel	J ver. steel
		b _j	V _{jh}	strength	area A _{sh}	area A _{sv}
	(mm)	(m)	(kN)	(kN)	(mm2)	(mm2)
1	14	0.40	0.	672.	0.	0.
2	24	0.50	0.	1609.	0.	0.
3	24	0.50	0.	1412.	0.	0.

* STOREY: 3 * BEAMS: 6 7

* Concrete: C25 - Long. Reinforcement: S500 - Stirrups: S500 - Cover: 35 (mm) *

GEOMETRY - BENDING MOMENTS M_{Ed} - LONGITUDINAL REINFORCEMENT

Location	Effect.	max M _{Ed}	Required	Beam bars	Provided	Flexural
	fl width	(kNm)	steel area	Contin Addit	steel area	capacity
	(m)	(kNm)	(mm2)		(mm2)	(kNm)
L end top	0.25	267.5	1740.	2 Φ 14 7 Φ 14	1753.	303.4
L end bot.	0.61	50.7	870.	2 Φ 14 4 Φ 14	924.	171.4
midspan	2.29	56.1	290.	2 Φ 14 1 Φ 14	462.	89.2
R end top	0.25	169.8	992.	2 Φ 14 1 Φ 18	985.	168.8
R end bot.	0.97	112.0	587.	2 Φ 14 1 Φ 20	622.	118.6

|Note: Top reinforcements include 250mm²/m of EC8s eff. slab width in tension |

|Beam: 7|Length l: 5.50m|X-section T | Depth h: 0.50m| Width bw: 0.25m |

Top flange thickness (m): 0.18 (L end) 0.18 (centre) 0.18 (R end)							
Location	Effect.	max MEd	Required	Beam bars	Provided	Flexural	
fl width			steel area	Contin	Addit	steel area	capacity
(m)	(kNm)	(kNm)	(mm ²)			(mm ²)	(kNm)
L end top	0.25	184.1	1090.	2Φ14	2Φ18	1239.	217.6
L end bot.	0.97	79.1	545.	2Φ14	1Φ20	622.	118.6
midspan	2.29	60.8	314.	2Φ14	1Φ14	462.	89.2
R end top	0.25	222.8	1372.	2Φ14	3Φ18	1314.	230.4
R end bot.	0.61	65.6	686.	2Φ14	2Φ20	936.	173.6

|Note: Top reinforcements include 250mm²/m of EC8s eff. slab width in tension |

SLS CHECKS: STRESS LIMITS, CRACK WIDTH CONTROL FOR Wmax=0.3mm & min STEEL AREA

Beam: 6									
Location	Characteristic loads G+Q	Quasi-permanent loads G+ψ2Q	Steel for						
Moment	steel	concrete	Moment concrete	Crack	cracking				
stress/fyk	stress/fck		stress/fck	spacing	width	min provd			
(kNm)			(kNm)	(mm)		(mm ²)			
L end top	127.7	0.450	0.315	108.4	0.267	185.9	0.11	121	1385
Midspan	43.6	0.444	0.057	37.0	0.049	296.6	0.17	62	461
R end top	34.2	0.265	0.118	28.9	0.100	248.4	0.08	263	562

Beam: 7									
Location	Characteristic loads G+Q	Quasi-permanent loads G+ψ2Q	Steel for						
Moment	steel	concrete	Moment concrete	Crack	cracking				
stress/fyk	stress/fck		stress/fck	spacing	width	min provd			
(kNm)			(kNm)	(mm)		(mm ²)			
L end top	61.9	0.320	0.188	52.5	0.159	218.8	0.09	279	816
Midspan	47.3	0.481	0.062	40.2	0.053	296.6	0.18	62	461
R end top	92.7	0.382	0.237	78.6	0.201	208.8	0.10	293	1071

JOINT GEOMETRY - SHEAR FORCES - VERIFICATION IN SHEAR

Joint	Max Φ	J width	J hor. shear	J hor. shear	J hor. steel	J ver. steel		
		bj	Vjh	strength	area Ash	area Asv		
(mm)	(mm)	(m)	(kN)	(kN)	(mm ²)	(mm ²)		
1	14	0.40	0.	598.	0.	0.		

```

| 2| 26 | 0.50 | 0. | 1358. | 0. | 0. |
| 3| 24 | 0.50 | 0. | 1273. | 0. | 0. |
+-----+-----+-----+-----+-----+-----+-----+

```

```

*-----*
* STOREY: 2 * BEAMS: 6 7
*-----*
* Concrete: C25 - Long. Reinforcement: S500 - Stirrups: S500 - Cover: 35 (mm) *
*-----*

```

GEOMETRY - BENDING MOMENTS MED - LONGITUDINAL REINFORCEMENT

```

+-----+
|Beam: 6|Length l: 5.60m|X-section T | Depth h: 0.50m| Width bw: 0.25m |
|-----+-----+-----+-----+-----+-----+-----+
| |Top flange thickness (m): 0.18 (L end) 0.18 (centre) 0.18 (R end)|
|-----+-----+-----+-----+-----+-----+-----+
| Location |Effect. | max MED | Required | Beam bars | Provided |Flexural|
| |fl width| |steel area |Contin Addit |steel area|capacity|
|-----+--- (m) ---+--- (kNm) ---+--- (mm2) ---+-----+--- (mm2) ---+--- (kNm) ---|
|L end top | 0.25 | 256.2 | 1642. | 2Φ14 6Φ14| 1599. | 278.7 |
|L end bot. | 0.61 | 49.1 | 821. | 2Φ14 3Φ16| 911. | 169.1 |
|midspan | 2.29 | 55.9 | 289. | 2Φ14 -- | 308. | 59.6 |
|R end top | 0.25 | 170.2 | 994. | 2Φ14 1Φ18| 985. | 168.8 |
|R end bot. | 0.97 | 102.1 | 534. | 2Φ14 1Φ20| 622. | 118.6 |
|Note: Top reinforcements include 250mm2/m of EC8s eff. slab width in tension |
+-----+

```

```

+-----+
|Beam: 7|Length l: 5.50m|X-section T | Depth h: 0.50m| Width bw: 0.25m |
|-----+-----+-----+-----+-----+-----+-----+
| |Top flange thickness (m): 0.18 (L end) 0.18 (centre) 0.18 (R end)|
|-----+-----+-----+-----+-----+-----+-----+
| Location |Effect. | max MED | Required | Beam bars | Provided |Flexural|
| |fl width| |steel area |Contin Addit |steel area|capacity|
|-----+--- (m) ---+--- (kNm) ---+--- (mm2) ---+-----+--- (mm2) ---+--- (kNm) ---|
|L end top | 0.25 | 183.2 | 1083. | 2Φ14 2Φ18| 1239. | 217.6 |
|L end bot. | 0.97 | 72.8 | 542. | 2Φ14 1Φ20| 622. | 118.6 |
|midspan | 2.29 | 60.3 | 312. | 2Φ14 1Φ14| 462. | 89.2 |
|R end top | 0.25 | 216.2 | 1322. | 2Φ14 3Φ18| 1314. | 230.4 |
|R end bot. | 0.61 | 63.1 | 661. | 2Φ14 2Φ20| 936. | 173.6 |
|Note: Top reinforcements include 250mm2/m of EC8s eff. slab width in tension |
+-----+

```

SLS CHECKS: STRESS LIMITS, CRACK WIDTH CONTROL FOR $W_{max}=0.3mm$ & min STEEL AREA

+-----+-----+-----+-----+-----+									
Beam: 6									
+-----+-----+-----+-----+-----+									
Location	Characteristic loads G+Q			Quasi-permanent loads G+ψ2Q			Steel for		
	Moment	steel	concrete	Moment	concrete	Crack	cracking		
	stress/fyk		stress/fck	stress/fck		spacing	width	min provd	
	-(kNm)			-(kNm)			-(mm)		-(mm2)--
L end top	122.0	0.478	0.310	103.5	0.264	191.7	0.12	121	1231
Midspan	43.5	0.656	0.070	36.9	0.059	359.1	0.30	62	307
R end top	40.2	0.312	0.139	34.1	0.117	248.4	0.10	263	562

+-----+-----+-----+-----+-----+									
Beam: 7									
+-----+-----+-----+-----+-----+									
Location	Characteristic loads G+Q			Quasi-permanent loads G+ψ2Q			Steel for		
	Moment	steel	concrete	Moment	concrete	Crack	cracking		
	stress/fyk		stress/fck	stress/fck		spacing	width	min provd	
	-(kNm)			-(kNm)			-(mm)		-(mm2)--
L end top	65.0	0.336	0.198	55.2	0.168	218.8	0.09	279	816
Midspan	47.0	0.478	0.062	39.8	0.052	296.6	0.18	62	461
R end top	90.3	0.372	0.231	76.6	0.196	208.8	0.10	293	1071

JOINT GEOMETRY - SHEAR FORCES - VERIFICATION IN SHEAR

+-----+-----+-----+-----+-----+									
Joint	Max Φ	J width	J hor. shear	J hor. shear	J hor. steel	J ver. steel			
		bj	Vjh	strength	area Ash	area Asv			
	(mm)	(m)	(kN)	(kN)	(mm2)	(mm2)			
1	16	0.40	0.	515.	0.	0.			
2	28	0.50	0.	1048.	0.	0.			
3	26	0.50	0.	1119.	0.	0.			

* STOREY: 1 * BEAMS: 6 7

* Concrete: C25 - Long. Reinforcement: S500 - Stirrups: S500 - Cover: 35 (mm) *

GEOMETRY - BENDING MOMENTS MED - LONGITUDINAL REINFORCEMENT

+-----+-----+-----+-----+-----+									
Beam: 6 Length l: 5.60m X-section T Depth h: 0.50m Width bw: 0.25m									
+-----+-----+-----+-----+-----+									
Top flange thickness (m): 0.18 (L end) 0.18 (centre) 0.18 (R end)									

Location	Effect.	max MEd	Required	Beam bars	Provided	Flexural
fl width			steel area	Contin Addit	steel area	capacity
--- (m) ---	--- (kNm) ---	--- (mm2) ---	--- (mm2) ---	--- (mm2) ---	--- (kNm) ---	
L end top	0.25	230.4	1431.	2Φ14 5Φ14	1445.	251.9
L end bot.	0.61	42.5	716.	2Φ14 2Φ16	710.	133.2
midspan	2.29	56.8	293.	2Φ14 1Φ14	462.	89.2
R end top	0.25	158.9	919.	2Φ14 1Φ16	931.	160.8
R end bot.	0.97	74.0	460.	2Φ14 1Φ20	622.	118.6

|Note: Top reinforcements include 250mm²/m of EC8s eff. slab width in tension |

|Beam: 7|Length l: 5.50m|X-section T | Depth h: 0.50m| Width bw: 0.25m |

|Top flange thickness (m): 0.18 (L end) 0.18 (centre) 0.18 (R end)|

Location	Effect.	max MEd	Required	Beam bars	Provided	Flexural
fl width			steel area	Contin Addit	steel area	capacity
--- (m) ---	--- (kNm) ---	--- (mm2) ---	--- (mm2) ---	--- (mm2) ---	--- (kNm) ---	
L end top	0.25	166.3	968.	2Φ14 1Φ16	931.	160.8
L end bot.	0.97	47.3	484.	2Φ14 1Φ20	622.	118.6
midspan	2.29	60.9	315.	2Φ14 1Φ14	462.	89.2
R end top	0.25	191.3	1140.	2Φ14 3Φ16	1154.	203.3
R end bot.	0.61	48.2	570.	2Φ14 1Φ20	622.	117.2

|Note: Top reinforcements include 250mm²/m of EC8s eff. slab width in tension |

SLS CHECKS: STRESS LIMITS, CRACK WIDTH CONTROL FOR Wmax=0.3mm & min STEEL AREA

|Beam: 6 |

Location	Characteristic loads G+Q	Quasi-permanent loads G+ψ2Q	Steel for						
Moment	steel stress/fyk	concrete stress/fck	Moment concrete stress/fck						
--- (kNm) ---	--- (kNm) ---	--- (kNm) ---	Crack spacing width min provd						
--- (kNm) ---	--- (kNm) ---	--- (kNm) ---	--- (mm) --- (mm2) ---						
L end top	110.6	0.491	0.312	93.9	0.265	198.1	0.12	121	1077
Midspan	44.2	0.450	0.058	37.5	0.049	296.6	0.17	62	461
R end top	50.1	0.423	0.177	42.5	0.150	252.1	0.14	241	508

|Beam: 7 |

|Location | Characteristic loads G+Q | Quasi-permanent loads G+ψ2Q | Steel for|

	Moment steel	concrete	Moment concrete	Crack	cracking
	stress/fyk	stress/fck	stress/fck	spacing	width min provd
	(kNm)		(kNm)	(mm)	(mm2)
L end top	70.1	0.517	0.237	59.5	0.201 249.3 0.16 241 508
Midspan	47.4	0.482	0.062	40.2	0.053 296.6 0.18 62 461
R end top	84.3	0.400	0.250	71.5	0.212 212.7 0.11 271 911

JOINT GEOMETRY - SHEAR FORCES - VERIFICATION IN SHEAR

Joint	Max Φ	J width	J hor. shear	J hor. shear	J hor. steel	J ver. steel
		b _j	V _{jh}	strength	area A _{sh}	area A _{sv}
	(mm)	(m)	(kN)	(kN)	(mm2)	(mm2)
1	16	0.40	0.	419.	0.	0.
2	30	0.50	0.	570.	0.	0.
3	26	0.50	0.	943.	0.	0.

* STOREY: 0 * BEAMS: 6 7

* Concrete: C25 - Long. Reinforcement: S500 - Stirrups: S500 - Cover: 35 (mm) *

GEOMETRY - BENDING MOMENTS M_{Ed} - LONGITUDINAL REINFORCEMENT

Location	Effect.	max M _{Ed}	Required	Beam bars	Provided	Flexural
	fl width	(kNm)	steel area	Contin Addit	steel area	capacity
	(m)	(kNm)	(mm2)		(mm2)	(kNm)
L end top	0.25	132.7	750.	2 Φ 10 3 Φ 16	760.	134.3
L end bot.	0.61	-57.3	149.	2 Φ 10 --	157.	30.3
midspan	2.29	54.8	283.	2 Φ 10 1 Φ 14	311.	60.2
R end top	0.25	85.4	466.	2 Φ 10 1 Φ 20	785.	138.3
R end bot.	0.97	-17.3	149.	2 Φ 10 --	157.	30.4

Beam:	7 Length l:	5.50m X-section	T	Depth h:	0.50m Width bw:	0.25m
		Top flange thickness (m): 0.18 (L end) 0.18 (centre) 0.18 (R end)				

Location	Effect.	max MED	Required	Beam bars	Provided	Flexural
fl width			steel area	Contin Addit	steel area	capacity
--- (m) ---	--- (kNm) ---	--- (mm ²) ---	--- (mm ²) ---	--- (mm ²) ---	--- (kNm) ---	
L end top	0.25	102.8	568.	2Φ10 1Φ20	785.	138.3
L end bot.	0.97	-26.3	149.	2Φ10 --	157.	30.4
midspan	2.29	60.0	310.	2Φ10 1Φ14	311.	60.2
R end top	0.25	108.4	601.	2Φ10 2Φ16	559.	101.4
R end bot.	0.61	-26.8	149.	2Φ10 --	157.	30.3

SLS CHECKS: STRESS LIMITS, CRACK WIDTH CONTROL FOR Wmax=0.3mm & min STEEL AREA

Location	Characteristic loads G+Q	Quasi-permanent loads G+ψ2Q	Steel for
Moment	steel	concrete	Moment concrete
stress/fyk	stress/fck	stress/fck	spacing width
--- (kNm) ---	--- (kNm) ---	--- (kNm) ---	--- (mm) ---
L end top	103.2	0.633	0.399
Midspan	42.7	0.638	0.068
R end top	60.6	0.362	0.233

Location	Characteristic loads G+Q	Quasi-permanent loads G+ψ2Q	Steel for
Moment	steel	concrete	Moment concrete
stress/fyk	stress/fck	stress/fck	spacing width
--- (kNm) ---	--- (kNm) ---	--- (kNm) ---	--- (mm) ---
L end top	76.1	0.414	0.284
Midspan	46.7	0.698	0.075
R end top	79.7	0.558	0.321

* STOREY: -1 * BEAMS: 6 7

* Concrete: C25 - Long. Reinforcement: S500 - Stirrups: S500 - Cover: 35 (mm) *

GEOMETRY - BENDING MOMENTS MED - LONGITUDINAL REINFORCEMENT

Beam: 6 Length l: 5.60m X-section T Depth h: 0.50m Width bw: 0.25m							
-----+-----							
Top flange thickness (m): 0.18 (L end) 0.18 (centre) 0.18 (R end)							
-----+-----							
Location	Effect.	max MEd	Required	Beam bars	Provided	Flexural	
fl width			steel area	Contin Addit	steel area	capacity	
-----+-- (m) -----+-- (kNm) -----+-- (mm2) -----+-- (mm2) -----+-- (kNm) --							
L end top	0.25	111.2	618.	2Φ10 3Φ14	619.	111.3	
L end bot.	0.61	-71.5	149.	2Φ10 --	157.	30.3	
midspan	2.29	56.7	293.	2Φ10 1Φ14	311.	60.2	
R end top	0.25	95.7	526.	2Φ10 3Φ12	609.	109.8	
R end bot.	0.97	-61.1	149.	2Φ10 --	157.	30.4	

Beam: 7 Length l: 5.50m X-section T Depth h: 0.50m Width bw: 0.25m							
-----+-----							
Top flange thickness (m): 0.18 (L end) 0.18 (centre) 0.18 (R end)							
-----+-----							
Location	Effect.	max MEd	Required	Beam bars	Provided	Flexural	
fl width			steel area	Contin Addit	steel area	capacity	
-----+-- (m) -----+-- (kNm) -----+-- (mm2) -----+-- (mm2) -----+-- (kNm) --							
L end top	0.25	107.0	593.	2Φ10 4Φ12	609.	109.8	
L end bot.	0.97	-66.8	149.	2Φ10 --	157.	30.4	
midspan	2.29	59.3	306.	2Φ10 1Φ14	311.	60.2	
R end top	0.25	94.6	519.	2Φ10 3Φ12	496.	90.7	
R end bot.	0.61	-57.9	149.	2Φ10 --	157.	30.3	

SLS CHECKS: STRESS LIMITS, CRACK WIDTH CONTROL FOR Wmax=0.3mm & min STEEL AREA

Beam: 6								
-----+-----								
Location	Characteristic loads G+Q			Quasi-permanent loads G+ψ2Q			Steel for	
	Moment	steel	concrete	Moment	concrete	Crack	cracking	
	stress/fyk		stress/fck	stress/fck		spacing	width	min provd
-----+-- (kNm) -----+-- (kNm) -----+-- (mm) -----+-- (mm2) --								
L end top	86.5	0.630	0.353	73.4	0.300	227.3	0.18	465 618
Midspan	44.1	0.659	0.071	37.4	0.060	321.8	0.27	62 311
R end top	74.5	0.549	0.306	63.2	0.259	211.8	0.15	586 609

Beam: 7							
-----+-----							

	(m)	(kNm)	(mm ²)	(mm ²)	(kNm)
L end top	0.25	117.0	653.	2Φ14	494. 90.3
L end bot.	0.61	56.6	327.	2Φ14	308. 58.9
midspan	1.09	27.3	287.	2Φ14	308. 59.3
R end top	0.25	124.9	702.	2Φ14 1Φ14	648. 116.2
R end bot.	0.61	46.0	351.	2Φ14 1Φ20	622. 117.2

|Note: Top reinforcements include 250mm²/m of EC8s eff. slab width in tension |

|Beam: 12|Length l: 5.30m|X-section InvL | Depth h: 0.50m| Width bw: 0.25m |

|Top flange thickness (m): 0.18 (L end) 0.18 (centre) 0.18 (R end)|

Location	Effect.	max MEd	Required	Beam bars	Provided	Flexural
	fl width		steel area	Contin Addit	steel area	capacity

L end top	0.25	120.9	677.	2Φ14 1Φ14	648.	116.2
L end bot.	0.61	50.6	339.	2Φ14	308.	58.9
midspan	1.09	25.1	287.	2Φ14	308.	59.3
R end top	0.25	120.9	677.	2Φ14 1Φ14	648.	116.2
R end bot.	0.61	50.6	339.	2Φ14	308.	58.9

|Note: Top reinforcements include 250mm²/m of EC8s eff. slab width in tension |

|Beam: 13|Length l: 5.30m|X-section InvL | Depth h: 0.50m| Width bw: 0.25m |

|Top flange thickness (m): 0.18 (L end) 0.18 (centre) 0.18 (R end)|

Location	Effect.	max MEd	Required	Beam bars	Provided	Flexural
	fl width		steel area	Contin Addit	steel area	capacity

L end top	0.25	124.9	702.	2Φ14 1Φ14	648.	116.2
L end bot.	0.61	46.0	351.	2Φ14 1Φ20	622.	117.2
midspan	1.09	27.3	287.	2Φ14	308.	59.3
R end top	0.25	117.0	653.	2Φ14 1Φ12	648.	116.2
R end bot.	0.61	56.6	327.	2Φ14	308.	58.9

|Note: Top reinforcements include 250mm²/m of EC8s eff. slab width in tension |

|Beam: 14|Length l: 5.50m|X-section InvL | Depth h: 0.50m| Width bw: 0.25m |

|Top flange thickness (m): 0.18 (L end) 0.18 (centre) 0.18 (R end)|

Location	Effect.	max MEd	Required	Beam bars	Provided	Flexural
fl width			steel area	Contin Addit	steel area	capacity
--- (m) ---	--- (kNm) ---	--- (mm ²) ---	--- (mm ²) ---	--- (mm ²) ---	--- (kNm) ---	
L end top	0.25	101.2	558.	2Φ14	-- 494.	90.3
L end bot.	0.61	45.3	287.	2Φ14	-- 308.	58.9
midspan	1.27	38.7	287.	2Φ14	-- 308.	59.4
R end top	0.25	85.7	467.	2Φ14	-- 454.	83.4
R end bot.	0.43	32.4	287.	2Φ14	-- 308.	58.5

|Note: Top reinforcements include 250mm²/m of EC8s eff. slab width in tension |

SLS CHECKS: STRESS LIMITS, CRACK WIDTH CONTROL FOR W_{max}=0.3mm & min STEEL AREA

Location	Characteristic loads G+Q	Quasi-permanent loads G+ψ ₂ Q	Steel for						
Moment	steel	concrete	cracking						
stress/fyk	stress/fck	stress/fck	spacing width						
--- (kNm) ---	--- (kNm) ---	--- (mm) ---	--- (mm ²) ---						
L end top	31.4	0.443	0.151	26.7	0.128	353.9	0.20	253	307
Midspan	30.1	0.462	0.065	25.6	0.055	359.1	0.21	62	307
R end top	33.0	0.466	0.159	28.0	0.134	330.4	0.20	302	307

Location	Characteristic loads G+Q	Quasi-permanent loads G+ψ ₂ Q	Steel for						
Moment	steel	concrete	cracking						
stress/fyk	stress/fck	stress/fck	spacing width						
--- (kNm) ---	--- (kNm) ---	--- (mm) ---	--- (mm ²) ---						
L end top	35.6	0.448	0.164	30.2	0.139	327.0	0.19	302	307
Midspan	21.3	0.327	0.050	18.0	0.042	359.1	0.15	62	307
R end top	46.5	0.425	0.169	39.5	0.144	273.7	0.15	302	461

Location	Characteristic loads G+Q	Quasi-permanent loads G+ψ ₂ Q	Steel for						
Moment	steel	concrete	cracking						
stress/fyk	stress/fck	stress/fck	spacing width						
--- (kNm) ---	--- (kNm) ---	--- (mm) ---	--- (mm ²) ---						
L end top	41.5	0.381	0.171	35.2	0.145	269.4	0.13	302	461
Midspan	19.6	0.301	0.046	16.6	0.039	359.1	0.14	62	307

R end top	41.5	0.381	0.171		35.2	0.145	269.4	0.13		302	461
+-----+-----+-----+-----+-----+-----+-----+-----+-----+-----+-----+-----+											
Beam: 13											
+-----+-----+-----+-----+-----+-----+-----+-----+-----+-----+-----+-----+											
Location	Characteristic loads G+Q			Quasi-permanent loads G+ψ2Q			Steel for				
	Moment steel		concrete	Moment concrete		Crack	cracking				
	stress/fyk		stress/fck	stress/fck		spacing	width	min provd			
-----+--	(kNm)		-----+--	(kNm)		-----	(mm)	-----+-- (mm2)--			
L end top	46.5	0.425	0.169		39.5	0.144	273.7	0.15		302	461
Midspan	21.3	0.327	0.050		18.0	0.042	359.1	0.15		62	307
R end top	35.6	0.327	0.147		30.2	0.125	275.6	0.11		315	461

Beam: 14											
+-----+-----+-----+-----+-----+-----+-----+-----+-----+-----+-----+-----+											
Location	Characteristic loads G+Q			Quasi-permanent loads G+ψ2Q			Steel for				
	Moment steel		concrete	Moment concrete		Crack	cracking				
	stress/fyk		stress/fck	stress/fck		spacing	width	min provd			
-----+--	(kNm)		-----+--	(kNm)		-----	(mm)	-----+-- (mm2)--			
L end top	33.0	0.303	0.136		28.0	0.115	275.6	0.11		315	461
Midspan	30.1	0.462	0.065		25.6	0.055	359.1	0.21		62	307
R end top	31.4	0.394	0.145		26.7	0.123	350.1	0.18		253	307

JOINT GEOMETRY - SHEAR FORCES - VERIFICATION IN SHEAR

Joint	Max Φ	J width	J hor. shear	J hor. shear	J hor. steel	J ver. steel
		bj	Vjh	strength	area Ash	area Asv
-----+--	(mm)	+--- (m)	----- (kN)	----- (kN)	----- (mm2)	----- (mm2)
	1	14	0.40	0.	807.	0.
	2	30	0.30	0.	1749.	0.
	3	30	0.30	0.	1765.	0.
	4	30	0.30	0.	1765.	0.
	5	30	0.30	0.	1749.	0.
	6	14	0.40	0.	807.	0.

* STOREY: 5 * BEAMS: 10 11 12 13 14

* Concrete: C25 - Long. Reinforcement: S500 - Stirrups: S500 - Cover: 35 (mm) *

GEOMETRY - BENDING MOMENTS MED - LONGITUDINAL REINFORCEMENT

```

+-----+
|Beam:   10|Length l: 5.50m|X-section InvL | Depth h: 0.50m| Width bw: 0.25m |
|-----+-----|
|           |Top flange thickness (m): 0.18 (L end) 0.18 (centre) 0.18 (R end)|
|-----+-----|
| Location |Effect. | max MEd | Required | Beam bars | Provided |Flexural|
|           |fl width|          | steel area |Contin Addit | steel area|capacity|
|-----+---(m)---+---(kNm)---+---(mm2)---+-----+---(mm2)---+---(kNm)---|
|L end top | 0.25  |  138.5 |   787.  | 2Φ14   2Φ14|   762.  | 134.6 |
|L end bot. | 0.43  |   58.7 |   393.  | 2Φ14   1Φ14|   462.  |  86.9 |
|midspan   | 1.27  |   33.1 |   287.  | 2Φ14   --  |   308.  |  59.4 |
|R end top  | 0.25  |  133.2 |   754.  | 2Φ14   1Φ18|   749.  | 132.4 |
|R end bot. | 0.61  |   89.0 |   469.  | 2Φ14   1Φ20|   622.  | 117.2 |
|Note: Top reinforcements include 250mm2/m of EC8s eff. slab width in tension |
+-----+

```

```

+-----+
|Beam:   11|Length l: 5.30m|X-section InvL | Depth h: 0.50m| Width bw: 0.25m |
|-----+-----|
|           |Top flange thickness (m): 0.18 (L end) 0.18 (centre) 0.18 (R end)|
|-----+-----|
| Location |Effect. | max MEd | Required | Beam bars | Provided |Flexural|
|           |fl width|          | steel area |Contin Addit | steel area|capacity|
|-----+---(m)---+---(kNm)---+---(mm2)---+-----+---(mm2)---+---(kNm)---|
|L end top | 0.25  |  153.4 |   883.  | 2Φ14   2Φ18|  1003.  | 177.2 |
|L end bot. | 0.61  |   94.6 |   499.  | 2Φ14   1Φ20|   622.  | 117.2 |
|midspan   | 1.09  |   27.2 |   287.  | 2Φ14   --  |   308.  |  59.3 |
|R end top  | 0.25  |  163.9 |   952.  | 2Φ14   2Φ16|   896.  | 155.5 |
|R end bot. | 0.61  |   83.1 |   476.  | 2Φ14   1Φ20|   622.  | 117.2 |
|Note: Top reinforcements include 250mm2/m of EC8s eff. slab width in tension |
+-----+

```

```

+-----+
|Beam:   12|Length l: 5.30m|X-section InvL | Depth h: 0.50m| Width bw: 0.25m |
|-----+-----|
|           |Top flange thickness (m): 0.18 (L end) 0.18 (centre) 0.18 (R end)|
|-----+-----|
| Location |Effect. | max MEd | Required | Beam bars | Provided |Flexural|
|           |fl width|          | steel area |Contin Addit | steel area|capacity|
|-----+---(m)---+---(kNm)---+---(mm2)---+-----+---(mm2)---+---(kNm)---|
|L end top | 0.25  |  159.4 |   922.  | 2Φ14   2Φ16|   896.  | 155.5 |
|L end bot. | 0.61  |   89.9 |   473.  | 2Φ14   1Φ20|   622.  | 117.2 |
|midspan   | 1.09  |   25.8 |   287.  | 2Φ14   --  |   308.  |  59.3 |
|R end top  | 0.25  |  159.4 |   922.  | 2Φ14   2Φ16|   896.  | 155.5 |
+-----+

```

R end bot.	0.61	89.9	473.	2Φ14	1Φ20	622.	117.2
Note: Top reinforcements include 250mm ² /m of EC8s eff. slab width in tension							
+-----+							
+-----+							
Beam:	13	Length l: 5.30m	X-section InvL	Depth h: 0.50m	Width bw: 0.25m		
-----+							
Top flange thickness (m): 0.18 (L end) 0.18 (centre) 0.18 (R end)							
-----+							
Location	Effect.	max MEd	Required	Beam bars	Provided	Flexural	
	fl width		steel area	Contin Addit	steel area	capacity	
-----+---(m)---+---(kNm)---+---(mm ²)---+-----+---(mm ²)---+---(kNm)---							
L end top	0.25	163.9	952.	2Φ14	2Φ16	896.	155.5
L end bot.	0.61	83.1	476.	2Φ14	1Φ20	622.	117.2
midspan	1.09	27.2	287.	2Φ14	--	308.	59.3
R end top	0.25	153.4	883.	2Φ14	2Φ18	1003.	177.2
R end bot.	0.61	94.6	499.	2Φ14	1Φ20	622.	117.2
Note: Top reinforcements include 250mm ² /m of EC8s eff. slab width in tension							
+-----+							
+-----+							
Beam:	14	Length l: 5.50m	X-section InvL	Depth h: 0.50m	Width bw: 0.25m		
-----+							
Top flange thickness (m): 0.18 (L end) 0.18 (centre) 0.18 (R end)							
-----+							
Location	Effect.	max MEd	Required	Beam bars	Provided	Flexural	
	fl width		steel area	Contin Addit	steel area	capacity	
-----+---(m)---+---(kNm)---+---(mm ²)---+-----+---(mm ²)---+---(kNm)---							
L end top	0.25	133.2	754.	2Φ14	1Φ18	749.	132.4
L end bot.	0.61	89.0	469.	2Φ14	1Φ20	622.	117.2
midspan	1.27	33.1	287.	2Φ14	--	308.	59.4
R end top	0.25	138.5	787.	2Φ14	2Φ14	762.	134.6
R end bot.	0.43	58.7	393.	2Φ14	1Φ14	462.	86.9
Note: Top reinforcements include 250mm ² /m of EC8s eff. slab width in tension							
+-----+							
+-----+							
SLS CHECKS: STRESS LIMITS, CRACK WIDTH CONTROL FOR Wmax=0.3mm & min STEEL AREA							
+-----+							
+-----+							
Beam:	10						
-----+							
Location	Characteristic loads G+Q	Quasi-permanent loads G+ψ2Q	Steel for				
	Moment steel	concrete	Moment concrete	Crack	cracking		
	stress/fyk	stress/fck	stress/fck	spacing	width	min provd	
-----+---(kNm)---+---(kNm)---+---(mm)---+---(mm ²)---							

L end top	46.9	0.361	0.171		39.9	0.145	247.4	0.11		253	615
Midspan	25.8	0.396	0.056		21.9	0.047	359.1	0.18		62	307
R end top	26.2	0.218	0.092		22.1	0.078	264.1	0.07		333	562

+-----+-----+-----+-----+-----+-----+-----+-----+-----+-----+
|Beam: 11 |

Location	Characteristic loads G+Q				Quasi-permanent loads G+ψ2Q			Steel for			
	Moment	steel	concrete		Moment	concrete	Crack	cracking			
	stress/fyk stress/fck		stress/fck spacing width		min provd						
-----+--	(kNm)	-----+--	(kNm)	-----+--	(mm)	-----+--	(mm2)	--			
L end top	34.6	0.196	0.108		29.4	0.092	227.8	0.06		345	816
Midspan	21.2	0.326	0.049		18.0	0.042	359.1	0.15		62	307
R end top	47.6	0.304	0.154		40.4	0.131	234.3	0.09		323	709

+-----+-----+-----+-----+-----+-----+-----+-----+-----+-----+
|Beam: 12 |

Location	Characteristic loads G+Q				Quasi-permanent loads G+ψ2Q			Steel for			
	Moment	steel	concrete		Moment	concrete	Crack	cracking			
	stress/fyk stress/fck		stress/fck spacing width		min provd						
-----+--	(kNm)	-----+--	(kNm)	-----+--	(mm)	-----+--	(mm2)	--			
L end top	41.0	0.262	0.133		34.7	0.112	234.3	0.08		323	709
Midspan	20.1	0.309	0.047		17.0	0.040	359.1	0.14		62	307
R end top	41.0	0.262	0.133		34.7	0.112	234.3	0.08		323	709

+-----+-----+-----+-----+-----+-----+-----+-----+-----+-----+
|Beam: 13 |

Location	Characteristic loads G+Q				Quasi-permanent loads G+ψ2Q			Steel for			
	Moment	steel	concrete		Moment	concrete	Crack	cracking			
	stress/fyk stress/fck		stress/fck spacing width		min provd						
-----+--	(kNm)	-----+--	(kNm)	-----+--	(mm)	-----+--	(mm2)	--			
L end top	47.6	0.304	0.154		40.4	0.131	234.3	0.09		323	709
Midspan	21.2	0.326	0.049		18.0	0.042	359.1	0.15		62	307
R end top	34.6	0.196	0.108		29.4	0.092	227.8	0.06		345	816

+-----+-----+-----+-----+-----+-----+-----+-----+-----+-----+
|Beam: 14 |

Location	Characteristic loads G+Q				Quasi-permanent loads G+ψ2Q			Steel for			
	Moment	steel	concrete		Moment	concrete	Crack	cracking			
	stress/fyk stress/fck		stress/fck spacing width		min provd						
-----+--	(kNm)	-----+--	(kNm)	-----+--	(mm)	-----+--	(mm2)	--			
L end top	26.2	0.203	0.090		22.1	0.076	262.5	0.07		333	562
Midspan	25.8	0.396	0.056		21.9	0.047	359.1	0.18		62	307

|R end top| 46.9 0.339 0.168 | 39.9 0.143 246.1 0.11 | 253 615|

+-----+-----+-----+-----+-----+-----+-----+-----+-----+
+-----+-----+-----+-----+-----+-----+-----+-----+-----+

JOINT GEOMETRY - SHEAR FORCES - VERIFICATION IN SHEAR

+-----+-----+-----+-----+-----+-----+-----+-----+-----+

Joint	Max Φ	J width bj	J hor. shear Vjh	J hor. shear strength	J hor. steel area Ash	J ver. steel area Asv
	(mm)	(m)	(kN)	(kN)	(mm ²)	(mm ²)
1	14	0.40	0.	764.	0.	0.
2	32	0.30	0.	1639.	0.	0.
3	32	0.30	0.	1673.	0.	0.
4	32	0.30	0.	1673.	0.	0.
5	32	0.30	0.	1639.	0.	0.
6	14	0.40	0.	764.	0.	0.

+-----+-----+-----+-----+-----+-----+-----+-----+-----+

* STOREY: 4 * BEAMS: 10 11 12 13 14

* Concrete: C25 - Long. Reinforcement: S500 - Stirrups: S500 - Cover: 35 (mm) *

GEOMETRY - BENDING MOMENTS MED - LONGITUDINAL REINFORCEMENT

+-----+-----+-----+-----+-----+-----+-----+-----+-----+

|Beam: 10|Length l: 5.50m|X-section InvL | Depth h: 0.50m| Width bw: 0.25m |

|-----+-----+-----+-----+-----+-----+-----+-----+-----|

| Top flange thickness (m): 0.18 (L end) 0.18 (centre) 0.18 (R end) |

|-----+-----+-----+-----+-----+-----+-----+-----+-----|

Location	Effect. fl width	max MED	Required steel area	Beam bars Contin Addit	Provided steel area	Flexural capacity
	(m)	(kNm)	(mm ²)		(mm ²)	(kNm)

|L end top | 0.25 | 138.4 | 786. | 2 Φ 14 2 Φ 14| 762. | 134.6 |

|L end bot. | 0.43 | 63.8 | 393. | 2 Φ 14 1 Φ 14| 462. | 86.9 |

|midspan | 1.27 | 33.9 | 287. | 2 Φ 14 -- | 308. | 59.4 |

|R end top | 0.25 | 138.1 | 785. | 2 Φ 14 1 Φ 18| 749. | 132.4 |

|R end bot. | 0.61 | 90.8 | 478. | 2 Φ 14 1 Φ 20| 622. | 117.2 |

|Note: Top reinforcements include 250mm²/m of EC8s eff. slab width in tension |

+-----+-----+-----+-----+-----+-----+-----+-----+-----+

+-----+-----+-----+-----+-----+-----+-----+-----+-----+

|Beam: 11|Length l: 5.30m|X-section InvL | Depth h: 0.50m| Width bw: 0.25m |

|-----+-----+-----+-----+-----+-----+-----+-----+-----|

| Top flange thickness (m): 0.18 (L end) 0.18 (centre) 0.18 (R end) |

|-----+-----+-----+-----+-----+-----+-----+-----+-----|

Location	Effect.	max MEd	Required	Beam bars	Provided	Flexural
fl width			steel area	Contin Addit	steel area	capacity
-----+-- (m) -----+-- (kNm) -----+-- (mm2) -----+-- (mm2) -----+-- (kNm) --						
L end top	0.25	157.9	912.	2Φ14 2Φ18	1003.	177.2
L end bot.	0.61	97.8	517.	2Φ14 1Φ20	622.	117.2
midspan	1.09	27.2	287.	2Φ14 --	308.	59.3
R end top	0.25	167.0	973.	2Φ14 2Φ16	896.	155.5
R end bot.	0.61	87.3	487.	2Φ14 1Φ20	622.	117.2

|Note: Top reinforcements include 250mm²/m of EC8s eff. slab width in tension |

+-----+
+-----+
|Beam: 12|Length l: 5.30m|X-section InvL | Depth h: 0.50m| Width bw: 0.25m |

|-----+
| |Top flange thickness (m): 0.18 (L end) 0.18 (centre) 0.18 (R end)|

Location	Effect.	max MEd	Required	Beam bars	Provided	Flexural
fl width			steel area	Contin Addit	steel area	capacity
-----+-- (m) -----+-- (kNm) -----+-- (mm2) -----+-- (mm2) -----+-- (kNm) --						
L end top	0.25	162.8	945.	2Φ14 2Φ16	896.	155.5
L end bot.	0.61	93.2	491.	2Φ14 1Φ20	622.	117.2
midspan	1.09	25.7	287.	2Φ14 --	308.	59.3
R end top	0.25	162.8	945.	2Φ14 2Φ16	896.	155.5
R end bot.	0.61	93.2	491.	2Φ14 1Φ20	622.	117.2

|Note: Top reinforcements include 250mm²/m of EC8s eff. slab width in tension |

+-----+
+-----+
|Beam: 13|Length l: 5.30m|X-section InvL | Depth h: 0.50m| Width bw: 0.25m |

|-----+
| |Top flange thickness (m): 0.18 (L end) 0.18 (centre) 0.18 (R end)|

Location	Effect.	max MEd	Required	Beam bars	Provided	Flexural
fl width			steel area	Contin Addit	steel area	capacity
-----+-- (m) -----+-- (kNm) -----+-- (mm2) -----+-- (mm2) -----+-- (kNm) --						
L end top	0.25	167.0	973.	2Φ14 2Φ16	896.	155.5
L end bot.	0.61	87.3	487.	2Φ14 1Φ20	622.	117.2
midspan	1.09	27.2	287.	2Φ14 --	308.	59.3
R end top	0.25	157.9	912.	2Φ14 2Φ18	1003.	177.2
R end bot.	0.61	97.8	517.	2Φ14 1Φ20	622.	117.2

|Note: Top reinforcements include 250mm²/m of EC8s eff. slab width in tension |

+-----+
+-----+
|Beam: 14|Length l: 5.50m|X-section InvL | Depth h: 0.50m| Width bw: 0.25m |

-----+-----							
Top flange thickness (m): 0.18 (L end) 0.18 (centre) 0.18 (R end)							
-----+-----							
Location	Effect.	max MEd	Required	Beam bars	Provided	Flexural	
	fl width		steel area	Contin Addit	steel area	capacity	
-----+-- (m)-----+-- (kNm)-----+-- (mm2)-----+-- (mm2)-----+-- (kNm)-----							
L end top	0.25	138.1	785.	2Φ14 1Φ18	749.	132.4	
L end bot.	0.61	90.8	478.	2Φ14 1Φ20	622.	117.2	
midspan	1.27	33.9	287.	2Φ14 --	308.	59.4	
R end top	0.25	138.4	786.	2Φ14 2Φ14	762.	134.6	
R end bot.	0.43	63.8	393.	2Φ14 1Φ14	462.	86.9	
Note: Top reinforcements include 250mm ² /m of EC8s eff. slab width in tension							
+-----+-----+							
+-----+-----+							
SLS CHECKS: STRESS LIMITS, CRACK WIDTH CONTROL FOR Wmax=0.3mm & min STEEL AREA							
+-----+-----+							
Beam: 10							
+-----+-----+							
Location	Characteristic loads G+Q			Quasi-permanent loads G+ψ2Q			Steel for
	Moment	steel	concrete	Moment	concrete	Crack	cracking
	stress/fyk	stress/fck		stress/fck	spacing	width	min provd
-----+-- (kNm)-----+-- (kNm)-----+-- (mm)-----+-- (mm2)-----							
L end top	43.9	0.338	0.160	37.3	0.136	247.4	0.11 253 615
Midspan	26.4	0.404	0.057	22.4	0.048	359.1	0.18 62 307
R end top	28.0	0.233	0.099	23.7	0.083	264.1	0.08 333 562
+-----+-----+							
Beam: 11							
+-----+-----+							
Location	Characteristic loads G+Q			Quasi-permanent loads G+ψ2Q			Steel for
	Moment	steel	concrete	Moment	concrete	Crack	cracking
	stress/fyk	stress/fck		stress/fck	spacing	width	min provd
-----+-- (kNm)-----+-- (kNm)-----+-- (mm)-----+-- (mm2)-----							
L end top	35.4	0.200	0.110	30.0	0.094	227.8	0.06 345 816
Midspan	21.1	0.326	0.049	17.9	0.042	359.1	0.15 62 307
R end top	47.0	0.300	0.152	39.9	0.129	234.3	0.09 323 709
+-----+-----+							
Beam: 12							
+-----+-----+							
Location	Characteristic loads G+Q			Quasi-permanent loads G+ψ2Q			Steel for
	Moment	steel	concrete	Moment	concrete	Crack	cracking
	stress/fyk	stress/fck		stress/fck	spacing	width	min provd
-----+-- (kNm)-----+-- (kNm)-----+-- (mm)-----+-- (mm2)-----							

L end top	41.0	0.262	0.133		34.8	0.113	234.3	0.08		323	709
Midspan	20.0	0.308	0.047		17.0	0.040	359.1	0.14		62	307
R end top	41.0	0.262	0.133		34.8	0.113	234.3	0.08		323	709

+-----+-----+-----+-----+-----+-----+-----+-----+-----+
|Beam: 13 |

Location	Characteristic loads G+Q			Quasi-permanent loads G+ψ2Q			Steel for				
	Moment	steel	concrete	Moment	concrete	Crack	cracking				
	stress/fyk		stress/fck	stress/fck		spacing	width	min provd			
-----+	(kNm)		-----+	(kNm)		----- (mm)	-----+	(mm2)--			
L end top	47.0	0.300	0.152		39.9	0.129	234.3	0.09		323	709
Midspan	21.1	0.326	0.049		17.9	0.042	359.1	0.15		62	307
R end top	35.4	0.200	0.110		30.0	0.094	227.8	0.06		345	816

+-----+-----+-----+-----+-----+-----+-----+-----+-----+
|Beam: 14 |

Location	Characteristic loads G+Q			Quasi-permanent loads G+ψ2Q			Steel for				
	Moment	steel	concrete	Moment	concrete	Crack	cracking				
	stress/fyk		stress/fck	stress/fck		spacing	width	min provd			
-----+	(kNm)		-----+	(kNm)		----- (mm)	-----+	(mm2)--			
L end top	28.0	0.217	0.096		23.7	0.082	262.5	0.07		333	562
Midspan	26.4	0.404	0.057		22.4	0.048	359.1	0.18		62	307
R end top	43.9	0.318	0.157		37.3	0.133	246.1	0.10		253	615

+-----+-----+-----+-----+-----+-----+-----+-----+-----+
+-----+-----+-----+-----+-----+-----+-----+-----+-----+
JOINT GEOMETRY - SHEAR FORCES - VERIFICATION IN SHEAR

Joint	Max Φ	J width	J hor. shear	J hor. shear	J hor. steel	J ver. steel
		bj	Vjh	strength	area Ash	area Asv
-----+	(mm)+	--- (m)---	--- (kN)---	--- (kN)---	--- (mm2)---	--- (mm2)---
1	14	0.40	0.	719.	0.	0.
2	34	0.30	0.	1522.	0.	0.
3	32	0.30	0.	1577.	0.	0.
4	32	0.30	0.	1577.	0.	0.
5	34	0.30	0.	1522.	0.	0.
6	14	0.40	0.	719.	0.	0.

* STOREY: 3 * BEAMS: 10 11 12 13 14

* Concrete: C25 - Long. Reinforcement: S500 - Stirrups: S500 - Cover: 35 (mm) *

GEOMETRY - BENDING MOMENTS MED - LONGITUDINAL REINFORCEMENT

+-----+

|Beam: 10|Length l: 5.50m|X-section InvL | Depth h: 0.50m| Width bw: 0.25m |

|-----|

| |Top flange thickness (m): 0.18 (L end) 0.18 (centre) 0.18 (R end)|

|-----|

Location	Effect.	max MED	Required	Beam bars	Provided	Flexural
fl width			steel area	Contin Addit	steel area	capacity
-----	---	---	---	-----	---	---
(m)	(kNm)	(kNm)	(mm2)	(mm2)	(mm2)	(kNm)
L end top	0.25	139.8	795.	2Φ14 2Φ14	762.	134.6
L end bot.	0.43	66.7	398.	2Φ14 1Φ14	462.	86.9
midspan	1.27	33.6	287.	2Φ14 --	308.	59.4
R end top	0.25	141.7	807.	2Φ14 1Φ20	808.	141.9
R end bot.	0.61	92.2	486.	2Φ14 1Φ20	622.	117.2

|-----|

|L end top | 0.25 | 139.8 | 795. | 2Φ14 2Φ14| 762. | 134.6 |

|L end bot. | 0.43 | 66.7 | 398. | 2Φ14 1Φ14| 462. | 86.9 |

|midspan | 1.27 | 33.6 | 287. | 2Φ14 -- | 308. | 59.4 |

|R end top | 0.25 | 141.7 | 807. | 2Φ14 1Φ20| 808. | 141.9 |

|R end bot. | 0.61 | 92.2 | 486. | 2Φ14 1Φ20| 622. | 117.2 |

|Note: Top reinforcements include 250mm2/m of EC8s eff. slab width in tension |

+-----+

+-----+

|Beam: 11|Length l: 5.30m|X-section InvL | Depth h: 0.50m| Width bw: 0.25m |

|-----|

| |Top flange thickness (m): 0.18 (L end) 0.18 (centre) 0.18 (R end)|

|-----|

Location	Effect.	max MED	Required	Beam bars	Provided	Flexural
fl width			steel area	Contin Addit	steel area	capacity
-----	---	---	---	-----	---	---
(m)	(kNm)	(kNm)	(mm2)	(mm2)	(mm2)	(kNm)
L end top	0.25	161.0	933.	2Φ14 2Φ20	1122.	198.0
L end bot.	0.61	100.1	529.	2Φ14 1Φ20	622.	117.2
midspan	1.09	27.1	287.	2Φ14 --	308.	59.3
R end top	0.25	169.4	989.	2Φ14 3Φ14	956.	164.5
R end bot.	0.61	90.4	494.	2Φ14 1Φ20	622.	117.2

|-----|

|L end top | 0.25 | 161.0 | 933. | 2Φ14 2Φ20| 1122. | 198.0 |

|L end bot. | 0.61 | 100.1 | 529. | 2Φ14 1Φ20| 622. | 117.2 |

|midspan | 1.09 | 27.1 | 287. | 2Φ14 -- | 308. | 59.3 |

|R end top | 0.25 | 169.4 | 989. | 2Φ14 3Φ14| 956. | 164.5 |

|R end bot. | 0.61 | 90.4 | 494. | 2Φ14 1Φ20| 622. | 117.2 |

|Note: Top reinforcements include 250mm2/m of EC8s eff. slab width in tension |

+-----+

+-----+

|Beam: 12|Length l: 5.30m|X-section InvL | Depth h: 0.50m| Width bw: 0.25m |

|-----|

| |Top flange thickness (m): 0.18 (L end) 0.18 (centre) 0.18 (R end)|

|-----|

Location	Effect.	max MED	Required	Beam bars	Provided	Flexural
fl width			steel area	Contin Addit	steel area	capacity
-----	---	---	---	-----	---	---
(m)	(kNm)	(kNm)	(mm2)	(mm2)	(mm2)	(kNm)
L end top	0.25	165.4	962.	2Φ14 3Φ14	956.	164.5
L end bot.	0.61	95.8	506.	2Φ14 1Φ20	622.	117.2

|-----|

|L end top | 0.25 | 165.4 | 962. | 2Φ14 3Φ14| 956. | 164.5 |

|L end bot. | 0.61 | 95.8 | 506. | 2Φ14 1Φ20| 622. | 117.2 |

midspan	1.09	25.7	287.	2Φ14	--	308.	59.3
R end top	0.25	165.4	962.	2Φ14	3Φ14	956.	164.5
R end bot.	0.61	95.8	506.	2Φ14	1Φ20	622.	117.2

|Note: Top reinforcements include 250mm²/m of EC8s eff. slab width in tension |

|Beam: 13|Length l: 5.30m|X-section InvL | Depth h: 0.50m| Width bw: 0.25m |

|Top flange thickness (m): 0.18 (L end) 0.18 (centre) 0.18 (R end)|

Location	Effect.	max MEd	Required	Beam bars	Provided	Flexural
fl width			steel area	Contin Addit	steel area	capacity
--- (m) ---	--- (kNm) ---	--- (mm ²) ---	--- (mm ²) ---	--- (mm ²) ---	--- (kNm) ---	
L end top	0.25	169.4	989.	2Φ14	3Φ14	956. 164.5
L end bot.	0.61	90.4	494.	2Φ14	1Φ20	622. 117.2
midspan	1.09	27.1	287.	2Φ14	--	308. 59.3
R end top	0.25	161.0	933.	2Φ14	2Φ20	1122. 198.0
R end bot.	0.61	100.1	529.	2Φ14	1Φ20	622. 117.2

|Note: Top reinforcements include 250mm²/m of EC8s eff. slab width in tension |

|Beam: 14|Length l: 5.50m|X-section InvL | Depth h: 0.50m| Width bw: 0.25m |

|Top flange thickness (m): 0.18 (L end) 0.18 (centre) 0.18 (R end)|

Location	Effect.	max MEd	Required	Beam bars	Provided	Flexural
fl width			steel area	Contin Addit	steel area	capacity
--- (m) ---	--- (kNm) ---	--- (mm ²) ---	--- (mm ²) ---	--- (mm ²) ---	--- (kNm) ---	
L end top	0.25	141.7	807.	2Φ14	1Φ20	808. 141.9
L end bot.	0.61	92.2	486.	2Φ14	1Φ20	622. 117.2
midspan	1.27	33.6	287.	2Φ14	--	308. 59.4
R end top	0.25	139.8	795.	2Φ14	2Φ14	762. 134.6
R end bot.	0.43	66.7	398.	2Φ14	1Φ14	462. 86.9

|Note: Top reinforcements include 250mm²/m of EC8s eff. slab width in tension |

SLS CHECKS: STRESS LIMITS, CRACK WIDTH CONTROL FOR W_{max}=0.3mm & min STEEL AREA

|Beam: 10

Location	Characteristic loads G+Q	Quasi-permanent loads G+ψ2Q	Steel for
	Moment steel	concrete Moment concrete	Crack cracking

	stress/fyk	stress/fck	stress/fyk	stress/fck	spacing	width	min	provd
	(kNm)		(kNm)		(mm)		(mm2)	
L end top	43.0	0.331	0.157	36.6	0.133	247.4	0.10	253 615
Midspan	26.2	0.401	0.056	22.2	0.048	359.1	0.18	62 307
R end top	29.3	0.223	0.100	24.8	0.085	258.7	0.07	348 622
+-----+-----+-----+-----+								
Beam: 11								
+-----+-----+-----+-----+								
Location	Characteristic loads G+Q			Quasi-permanent loads G+ψ2Q			Steel for	
	Moment	steel	concrete	Moment	concrete	Crack	cracking	
	stress/fyk	stress/fck	stress/fyk	stress/fck	spacing	width	min provd	
	(kNm)		(kNm)		(mm)		(mm2)	
L end top	35.9	0.181	0.108	30.5	0.092	221.8	0.05	360 936
Midspan	21.1	0.325	0.049	17.9	0.042	359.1	0.15	62 307
R end top	46.5	0.277	0.147	39.5	0.125	221.2	0.08	302 769
+-----+-----+-----+-----+								
Beam: 12								
+-----+-----+-----+-----+								
Location	Characteristic loads G+Q			Quasi-permanent loads G+ψ2Q			Steel for	
	Moment	steel	concrete	Moment	concrete	Crack	cracking	
	stress/fyk	stress/fck	stress/fyk	stress/fck	spacing	width	min provd	
	(kNm)		(kNm)		(mm)		(mm2)	
L end top	41.0	0.244	0.130	34.8	0.110	221.2	0.07	302 769
Midspan	20.0	0.308	0.047	17.0	0.040	359.1	0.14	62 307
R end top	41.0	0.244	0.130	34.8	0.110	221.2	0.07	302 769
+-----+-----+-----+-----+								
Beam: 13								
+-----+-----+-----+-----+								
Location	Characteristic loads G+Q			Quasi-permanent loads G+ψ2Q			Steel for	
	Moment	steel	concrete	Moment	concrete	Crack	cracking	
	stress/fyk	stress/fck	stress/fyk	stress/fck	spacing	width	min provd	
	(kNm)		(kNm)		(mm)		(mm2)	
L end top	46.5	0.277	0.147	39.5	0.125	221.2	0.08	302 769
Midspan	21.1	0.325	0.049	17.9	0.042	359.1	0.15	62 307
R end top	35.9	0.181	0.108	30.5	0.092	221.8	0.05	360 936
+-----+-----+-----+-----+								
Beam: 14								
+-----+-----+-----+-----+								
Location	Characteristic loads G+Q			Quasi-permanent loads G+ψ2Q			Steel for	
	Moment	steel	concrete	Moment	concrete	Crack	cracking	
	stress/fyk	stress/fck	stress/fyk	stress/fck	spacing	width	min provd	
	(kNm)		(kNm)		(mm)		(mm2)	

Top flange thickness (m): 0.18 (L end) 0.18 (centre) 0.18 (R end)							
-----+-----							
Location	Effect.	max MEd	Required	Beam bars	Provided	Flexural	
fl width			steel area	Contin	Addit	steel area	capacity
-----+-- (m) -----+-- (kNm) -----+-- (mm2) -----+-----+-- (mm2) -----+-- (kNm) --							
L end top	0.25	156.1	901.	2Φ14	3Φ14	956.	164.5
L end bot.	0.61	94.0	496.	2Φ14	1Φ20	622.	117.2
midspan	1.09	27.1	287.	2Φ14	--	308.	59.3
R end top	0.25	163.4	949.	2Φ14	2Φ16	896.	155.5
R end bot.	0.61	85.6	474.	2Φ14	1Φ20	622.	117.2
Note: Top reinforcements include 250mm2/m of EC8s eff. slab width in tension							
+-----+-----+							

|Beam: 12|Length l: 5.30m|X-section InvL | Depth h: 0.50m| Width bw: 0.25m |

Top flange thickness (m): 0.18 (L end) 0.18 (centre) 0.18 (R end)							
-----+-----							
Location	Effect.	max MEd	Required	Beam bars	Provided	Flexural	
fl width			steel area	Contin	Addit	steel area	capacity
-----+-- (m) -----+-- (kNm) -----+-- (mm2) -----+-----+-- (mm2) -----+-- (kNm) --							
L end top	0.25	159.8	925.	2Φ14	2Φ16	896.	155.5
L end bot.	0.61	90.3	476.	2Φ14	1Φ20	622.	117.2
midspan	1.09	25.8	287.	2Φ14	--	308.	59.3
R end top	0.25	159.8	925.	2Φ14	2Φ16	896.	155.5
R end bot.	0.61	90.3	476.	2Φ14	1Φ20	622.	117.2
Note: Top reinforcements include 250mm2/m of EC8s eff. slab width in tension							
+-----+-----+							

|Beam: 13|Length l: 5.30m|X-section InvL | Depth h: 0.50m| Width bw: 0.25m |

Top flange thickness (m): 0.18 (L end) 0.18 (centre) 0.18 (R end)							
-----+-----							
Location	Effect.	max MEd	Required	Beam bars	Provided	Flexural	
fl width			steel area	Contin	Addit	steel area	capacity
-----+-- (m) -----+-- (kNm) -----+-- (mm2) -----+-----+-- (mm2) -----+-- (kNm) --							
L end top	0.25	163.4	949.	2Φ14	2Φ16	896.	155.5
L end bot.	0.61	85.6	474.	2Φ14	1Φ20	622.	117.2
midspan	1.09	27.1	287.	2Φ14	--	308.	59.3
R end top	0.25	156.1	901.	2Φ14	3Φ14	956.	164.5
R end bot.	0.61	94.0	496.	2Φ14	1Φ20	622.	117.2
Note: Top reinforcements include 250mm2/m of EC8s eff. slab width in tension							
+-----+-----+							

```

+-----+
|Beam:   14|Length l: 5.50m|X-section InvL | Depth h: 0.50m| Width bw: 0.25m |
|-----+-----+-----+-----+-----+-----+-----+
|           |Top flange thickness (m): 0.18 (L end) 0.18 (centre) 0.18 (R end)|
|-----+-----+-----+-----+-----+-----+
| Location |Effect. | max MEd | Required | Beam bars | Provided |Flexural|
|           |fl width|          | steel area |Contin Addit | steel area|capacity|
|-----+---(m)---+---(kNm)---+---(mm2)---+-----+---(mm2)---+---(kNm)---|
|L end top | 0.25  |  138.6 |   787.  | 2Φ14   2Φ14|   802.  | 140.9 |
|L end bot. | 0.61  |   86.3 |   454.  | 2Φ14   1Φ20|   622.  | 117.2 |
|midspan   | 1.27  |   33.2 |   287.  | 2Φ14   --  |   308.  |  59.4 |
|R end top  | 0.25  |  135.2 |   766.  | 2Φ14   2Φ14|   762.  | 134.6 |
|R end bot. | 0.43  |   63.7 |   383.  | 2Φ14   1Φ14|   462.  |  86.9 |
|Note: Top reinforcements include 250mm2/m of EC8s eff. slab width in tension |
+-----+

```

SLS CHECKS: STRESS LIMITS, CRACK WIDTH CONTROL FOR $W_{max}=0.3\text{mm}$ & min STEEL AREA

```

+-----+
|Beam:   10
+-----+
|Location | Characteristic loads G+Q | Quasi-permanent loads G+ψ2Q |Steel for|
|           |Moment steel   concrete |Moment concrete   Crack   | cracking|
|           | stress/fyk stress/fck| stress/fck spacing width |min provd|
|-----+---(kNm)---+-----+---(kNm)---+-----+---(mm)---+---(mm2)---|
|L end top| 42.1  0.324  0.154 | 35.8  0.130  247.4  0.10 | 253 615|
| Midspan | 25.8  0.396  0.056 | 21.9  0.047  359.1  0.18 |  62 307|
|R end top| 30.9  0.237  0.106 | 26.1  0.090  242.6  0.07 | 302 615|
+-----+

```

```

+-----+
|Beam:   11
+-----+
|Location | Characteristic loads G+Q | Quasi-permanent loads G+ψ2Q |Steel for|
|           |Moment steel   concrete |Moment concrete   Crack   | cracking|
|           | stress/fyk stress/fck| stress/fck spacing width |min provd|
|-----+---(kNm)---+-----+---(kNm)---+-----+---(mm)---+---(mm2)---|
|L end top| 36.6  0.218  0.116 | 31.1  0.098  221.2  0.06 | 302 769|
| Midspan | 21.1  0.325  0.049 | 17.9  0.042  359.1  0.15 |  62 307|
|R end top| 45.8  0.293  0.148 | 38.9  0.126  234.3  0.09 | 323 709|
+-----+

```

```

+-----+
|Beam:   12
+-----+
|Location | Characteristic loads G+Q | Quasi-permanent loads G+ψ2Q |Steel for|
|           |Moment steel   concrete |Moment concrete   Crack   | cracking|
+-----+

```

	stress/fyk	stress/fck	stress/fyk	stress/fck	stress/fck	spacing	width	min	provd
	(kNm)		(kNm)		(kNm)	(mm)		(mm2)	
L end top	41.0	0.261	0.133	34.7	0.112	234.3	0.08	323	709
Midspan	20.1	0.309	0.047	17.0	0.040	359.1	0.14	62	307
R end top	41.0	0.261	0.133	34.7	0.112	234.3	0.08	323	709

|Beam: 13

Location	Characteristic loads G+Q			Quasi-permanent loads G+ψ2Q			Steel for		
	Moment	steel	concrete	Moment	concrete	Crack	cracking		
	stress/fyk	stress/fck	stress/fyk	stress/fck	stress/fck	spacing	width	min	provd
	(kNm)		(kNm)		(kNm)	(mm)		(mm2)	
L end top	45.8	0.293	0.148	38.9	0.126	234.3	0.09	323	709
Midspan	21.1	0.325	0.049	17.9	0.042	359.1	0.15	62	307
R end top	36.6	0.218	0.116	31.1	0.098	221.2	0.06	302	769

|Beam: 14

Location	Characteristic loads G+Q			Quasi-permanent loads G+ψ2Q			Steel for		
	Moment	steel	concrete	Moment	concrete	Crack	cracking		
	stress/fyk	stress/fck	stress/fyk	stress/fck	stress/fck	spacing	width	min	provd
	(kNm)		(kNm)		(kNm)	(mm)		(mm2)	
L end top	30.9	0.223	0.104	26.1	0.088	241.4	0.07	302	615
Midspan	25.8	0.396	0.056	21.9	0.047	359.1	0.18	62	307
R end top	42.1	0.304	0.150	35.8	0.128	246.1	0.10	253	615

JOINT GEOMETRY - SHEAR FORCES - VERIFICATION IN SHEAR

Joint	Max Φ	J width	J hor. shear	J hor. shear	J hor. steel	J ver. steel
		bj	Vjh	strength	area Ash	area Asv
	(mm)	(m)	(kN)	(kN)	(mm2)	(mm2)
1	14	0.40	0.	621.	0.	0.
2	36	0.30	0.	1259.	0.	0.
3	34	0.30	0.	1368.	0.	0.
4	34	0.30	0.	1368.	0.	0.
5	36	0.30	0.	1259.	0.	0.
6	14	0.40	0.	621.	0.	0.

* STOREY: 1 * BEAMS: 10 11 12 13 14

 * Concrete: C25 - Long. Reinforcement: S500 - Stirrups: S500 - Cover: 35 (mm) *

GEOMETRY - BENDING MOMENTS MED - LONGITUDINAL REINFORCEMENT

+-----+							
Beam: 10 Length l: 5.50m X-section InvL Depth h: 0.50m Width bw: 0.25m							
-----+							
Top flange thickness (m): 0.18 (L end) 0.18 (centre) 0.18 (R end)							
-----+							
Location	Effect.	max MEd	Required	Beam bars	Provided	Flexural	
fl width			steel area	Contin Addit	steel area	capacity	
-----	---	---	---	-----	---	---	---
(m)		(kNm)	(mm2)		(mm2)		(kNm)
L end top	0.25	114.3	636.	2Φ14 1Φ14	608.	109.6	
L end bot.	0.43	52.7	318.	2Φ14 --	308.	58.5	
midspan	1.27	34.4	287.	2Φ14 --	308.	59.4	
R end top	0.25	126.1	709.	2Φ14 1Φ16	695.	123.8	
R end bot.	0.61	67.1	355.	2Φ14 1Φ20	622.	117.2	
Note: Top reinforcements include 250mm2/m of EC8s eff. slab width in tension							

+-----+							
Beam: 11 Length l: 5.30m X-section InvL Depth h: 0.50m Width bw: 0.25m							
-----+							
Top flange thickness (m): 0.18 (L end) 0.18 (centre) 0.18 (R end)							
-----+							
Location	Effect.	max MEd	Required	Beam bars	Provided	Flexural	
fl width			steel area	Contin Addit	steel area	capacity	
-----	---	---	---	-----	---	---	---
(m)		(kNm)	(mm2)		(mm2)		(kNm)
L end top	0.25	141.1	804.	2Φ14 2Φ16	896.	155.5	
L end bot.	0.61	76.6	402.	2Φ14 1Φ20	622.	117.2	
midspan	1.09	26.9	287.	2Φ14 --	308.	59.3	
R end top	0.25	146.1	836.	2Φ14 1Φ20	808.	141.9	
R end bot.	0.61	70.3	418.	2Φ14 1Φ20	622.	117.2	
Note: Top reinforcements include 250mm2/m of EC8s eff. slab width in tension							

+-----+							
Beam: 12 Length l: 5.30m X-section InvL Depth h: 0.50m Width bw: 0.25m							
-----+							
Top flange thickness (m): 0.18 (L end) 0.18 (centre) 0.18 (R end)							
-----+							
Location	Effect.	max MEd	Required	Beam bars	Provided	Flexural	
fl width			steel area	Contin Addit	steel area	capacity	
-----	---	---	---	-----	---	---	---
(m)		(kNm)	(mm2)		(mm2)		(kNm)

L end top	0.25	143.1	816.	2Φ14	1Φ20	808.	141.9
L end bot.	0.61	73.7	408.	2Φ14	1Φ20	622.	117.2
midspan	1.09	25.8	287.	2Φ14	--	308.	59.3
R end top	0.25	143.1	816.	2Φ14	1Φ20	808.	141.9
R end bot.	0.61	73.7	408.	2Φ14	1Φ20	622.	117.2

|Note: Top reinforcements include 250mm²/m of EC8s eff. slab width in tension |

-----+
-----+

|Beam: 13|Length l: 5.30m|X-section InvL | Depth h: 0.50m| Width bw: 0.25m |

|-----+-----|

| |Top flange thickness (m): 0.18 (L end) 0.18 (centre) 0.18 (R end)|

|-----+-----|

Location	Effect.	max MEd	Required	Beam bars	Provided	Flexural
fl width			steel area	Contin Addit	steel area	capacity
-----+-- (m) -----+-- (kNm) -----+-- (mm ²) -----+-- (mm ²) -----+-- (kNm) --						

L end top	0.25	146.1	836.	2Φ14	1Φ20	808.	141.9
L end bot.	0.61	70.3	418.	2Φ14	1Φ20	622.	117.2
midspan	1.09	26.9	287.	2Φ14	--	308.	59.3
R end top	0.25	141.1	804.	2Φ14	2Φ16	896.	155.5
R end bot.	0.61	76.6	402.	2Φ14	1Φ20	622.	117.2

|Note: Top reinforcements include 250mm²/m of EC8s eff. slab width in tension |

-----+
-----+

|Beam: 14|Length l: 5.50m|X-section InvL | Depth h: 0.50m| Width bw: 0.25m |

|-----+-----|

| |Top flange thickness (m): 0.18 (L end) 0.18 (centre) 0.18 (R end)|

|-----+-----|

Location	Effect.	max MEd	Required	Beam bars	Provided	Flexural
fl width			steel area	Contin Addit	steel area	capacity
-----+-- (m) -----+-- (kNm) -----+-- (mm ²) -----+-- (mm ²) -----+-- (kNm) --						

L end top	0.25	126.1	709.	2Φ14	1Φ16	695.	123.8
L end bot.	0.61	67.1	355.	2Φ14	1Φ20	622.	117.2
midspan	1.27	34.4	287.	2Φ14	--	308.	59.4
R end top	0.25	114.3	636.	2Φ14	1Φ14	608.	109.6
R end bot.	0.43	52.7	318.	2Φ14	--	308.	58.5

|Note: Top reinforcements include 250mm²/m of EC8s eff. slab width in tension |

-----+
-----+

SLS CHECKS: STRESS LIMITS, CRACK WIDTH CONTROL FOR Wmax=0.3mm & min STEEL AREA

|-----+-----|

|Beam: 10 |

|-----+-----|

Location	Characteristic loads G+Q			Quasi-permanent loads G+ψ2Q				Steel for	
	Moment	steel	concrete	Moment	concrete	Crack		cracking	
		stress/fyk	stress/fck		stress/fck	spacing	width	min	provd
	(kNm)			(kNm)		(mm)		(mm2)	
L end top	36.2	0.361	0.154	30.8	0.131	282.5	0.13	253	461
Midspan	26.8	0.411	0.058	22.7	0.049	359.1	0.19	62	307
R end top	34.9	0.317	0.127	29.5	0.107	269.7	0.11	316	508

Beam: 11

Location	Characteristic loads G+Q			Quasi-permanent loads G+ψ2Q				Steel for	
	Moment	steel	concrete	Moment	concrete	Crack		cracking	
		stress/fyk	stress/fck		stress/fck	spacing	width	min	provd
	(kNm)			(kNm)		(mm)		(mm2)	
L end top	38.1	0.243	0.123	32.3	0.104	234.3	0.07	323	709
Midspan	21.0	0.323	0.049	17.8	0.041	359.1	0.15	62	307
R end top	44.7	0.319	0.150	37.9	0.127	257.2	0.10	348	622

Beam: 12

Location	Characteristic loads G+Q			Quasi-permanent loads G+ψ2Q				Steel for	
	Moment	steel	concrete	Moment	concrete	Crack		cracking	
		stress/fyk	stress/fck		stress/fck	spacing	width	min	provd
	(kNm)			(kNm)		(mm)		(mm2)	
L end top	40.9	0.292	0.137	34.7	0.116	257.2	0.10	348	622
Midspan	20.1	0.309	0.047	17.0	0.040	359.1	0.14	62	307
R end top	40.9	0.292	0.137	34.7	0.116	257.2	0.10	348	622

Beam: 13

Location	Characteristic loads G+Q			Quasi-permanent loads G+ψ2Q				Steel for	
	Moment	steel	concrete	Moment	concrete	Crack		cracking	
		stress/fyk	stress/fck		stress/fck	spacing	width	min	provd
	(kNm)			(kNm)		(mm)		(mm2)	
L end top	44.7	0.319	0.150	37.9	0.127	257.2	0.10	348	622
Midspan	21.0	0.323	0.049	17.8	0.041	359.1	0.15	62	307
R end top	38.1	0.243	0.123	32.3	0.104	234.3	0.07	323	709

Beam: 14

Location	Characteristic loads G+Q			Quasi-permanent loads G+ψ2Q				Steel for	
	Moment	steel	concrete	Moment	concrete	Crack		cracking	

	stress/fyk	stress/fck	stress/fck	spacing	width	min	provd
	(kNm)	(kNm)	(kNm)	(mm)	(mm)	(mm)	(mm ²)
L end top	34.9	0.294	0.123	29.5	0.104	268.0	0.10 316 508
Midspan	26.8	0.411	0.058	22.7	0.049	359.1	0.19 62 307
R end top	36.2	0.333	0.149	30.8	0.127	280.3	0.12 253 461

JOINT GEOMETRY - SHEAR FORCES - VERIFICATION IN SHEAR

Joint	Max Φ	J width	J hor. shear	J hor. shear	J hor. steel	J ver. steel
		b _j	V _{jh}	strength	area A _{sh}	area A _{sv}
(mm)	(mm)	(m)	(kN)	(kN)	(mm ²)	(mm ²)
1	14	0.40	0.	574.	0.	0.
2	36	0.30	0.	1112.	0.	0.
3	36	0.30	0.	1257.	0.	0.
4	36	0.30	0.	1257.	0.	0.
5	36	0.30	0.	1112.	0.	0.
6	14	0.40	0.	574.	0.	0.

* STOREY: 0 * BEAMS: 10 11 12 13 14

* Concrete: C25 - Long. Reinforcement: S500 - Stirrups: S500 - Cover: 35 (mm) *

GEOMETRY - BENDING MOMENTS MED - LONGITUDINAL REINFORCEMENT

Location	Effect.	max MED	Required	Beam bars	Provided	Flexural
fl width		(kNm)	steel area	Contin	Addit	steel area capacity
(m)		(kNm)	(mm ²)	(mm ²)	(mm ²)	(kNm)
L end top	0.25	115.6	645.	2 Φ 10	3 Φ 14	619. 111.3
L end bot.	0.43	-53.9	149.	2 Φ 10	--	157. 30.2
midspan	1.27	56.0	290.	2 Φ 10	1 Φ 14	311. 60.0
R end top	0.25	92.7	508.	2 Φ 10	1 Φ 20	785. 138.3
R end bot.	0.61	-30.1	149.	2 Φ 10	--	157. 30.3

Beam: 11 | Length l: 5.30m | X-section InvL | Depth h: 0.50m | Width bw: 0.25m |

```

|-----+-----|
|           |Top flange thickness (m): 0.18 (L end) 0.18 (centre) 0.18 (R end)|
|-----+-----|
| Location |Effect. | max MEd | Required | Beam bars   | Provided |Flexural|
|           |fl width|          | steel area| Contin Addit| steel area|capacity|
|-----+---(m)---+---(kNm)---+---(mm2)---+-----+---(mm2)---+---(kNm)---|
|L end top  | 0.25   | 105.7   | 585.    | 2Φ10  1Φ20| 785.   | 138.3 |
|L end bot. | 0.61   | -29.1   | 149.    | 2Φ10   -- | 157.   | 30.3  |
|midspan    | 1.09   | 53.8    | 279.    | 2Φ10  1Φ14| 311.   | 59.9  |
|R end top  | 0.25   | 110.7   | 615.    | 2Φ10  2Φ16| 559.   | 101.4 |
|R end bot. | 0.61   | -35.0   | 149.    | 2Φ10   -- | 157.   | 30.3  |
+-----+-----+

```

Beam: 12 | Length l: 5.30m | X-section InvL | Depth h: 0.50m | Width bw: 0.25m |

```

|-----+-----|
|           |Top flange thickness (m): 0.18 (L end) 0.18 (centre) 0.18 (R end)|
|-----+-----|
| Location |Effect. | max MEd | Required | Beam bars   | Provided |Flexural|
|           |fl width|          | steel area| Contin Addit| steel area|capacity|
|-----+---(m)---+---(kNm)---+---(mm2)---+-----+---(mm2)---+---(kNm)---|
|L end top  | 0.25   | 109.3   | 606.    | 2Φ10  2Φ16| 559.   | 101.4 |
|L end bot. | 0.61   | -33.3   | 149.    | 2Φ10   -- | 157.   | 30.3  |
|midspan    | 1.09   | 53.7    | 279.    | 2Φ10  1Φ14| 311.   | 59.9  |
|R end top  | 0.25   | 109.3   | 606.    | 2Φ10  2Φ16| 559.   | 101.4 |
|R end bot. | 0.61   | -33.3   | 149.    | 2Φ10   -- | 157.   | 30.3  |
+-----+-----+

```

Beam: 13 | Length l: 5.30m | X-section InvL | Depth h: 0.50m | Width bw: 0.25m |

```

|-----+-----|
|           |Top flange thickness (m): 0.18 (L end) 0.18 (centre) 0.18 (R end)|
|-----+-----|
| Location |Effect. | max MEd | Required | Beam bars   | Provided |Flexural|
|           |fl width|          | steel area| Contin Addit| steel area|capacity|
|-----+---(m)---+---(kNm)---+---(mm2)---+-----+---(mm2)---+---(kNm)---|
|L end top  | 0.25   | 110.7   | 615.    | 2Φ10  2Φ16| 559.   | 101.4 |
|L end bot. | 0.61   | -35.0   | 149.    | 2Φ10   -- | 157.   | 30.3  |
|midspan    | 1.09   | 53.8    | 279.    | 2Φ10  1Φ14| 311.   | 59.9  |
|R end top  | 0.25   | 105.7   | 585.    | 2Φ10  1Φ20| 785.   | 138.3 |
|R end bot. | 0.61   | -29.1   | 149.    | 2Φ10   -- | 157.   | 30.3  |
+-----+-----+

```

Beam: 14 | Length l: 5.50m | X-section InvL | Depth h: 0.50m | Width bw: 0.25m |

-----+-----							
Top flange thickness (m): 0.18 (L end) 0.18 (centre) 0.18 (R end)							
-----+-----							
Location	Effect.	max MEd	Required	Beam bars	Provided	Flexural	
	fl width		steel area	Contin Addit	steel area	capacity	
-----+-- (m)-----+-- (kNm)-----+-- (mm2)-----+-- (mm2)-----+-- (kNm)-----							
L end top	0.25	92.7	508.	2Φ10 1Φ20	785.	138.3	
L end bot.	0.61	-30.1	149.	2Φ10 --	157.	30.3	
midspan	1.27	56.0	290.	2Φ10 1Φ14	311.	60.0	
R end top	0.25	115.6	645.	2Φ10 3Φ14	619.	111.3	
R end bot.	0.43	-53.9	149.	2Φ10 --	157.	30.2	

SLS CHECKS: STRESS LIMITS, CRACK WIDTH CONTROL FOR Wmax=0.3mm & min STEEL AREA

-----+-----									
Beam: 10									
-----+-----									
Location	Characteristic loads G+Q			Quasi-permanent loads G+ψ2Q			Steel for		
	Moment	steel	concrete	Moment	concrete	Crack	cracking		
	stress/fyk	stress/fck		stress/fck	spacing	width	min provd		
-----+-- (kNm)-----+-- (kNm)-----+-- (mm)-----+-- (mm2)-----									
L end top	89.9	0.697	0.375	76.4	0.318	234.0	0.21	380	618
Midspan	43.6	0.661	0.094	37.0	0.080	321.8	0.27	62	311
R end top	72.1	0.452	0.281	61.1	0.238	229.3	0.13	536	785

-----+-----									
Beam: 11									
-----+-----									
Location	Characteristic loads G+Q			Quasi-permanent loads G+ψ2Q			Steel for		
	Moment	steel	concrete	Moment	concrete	Crack	cracking		
	stress/fyk	stress/fck		stress/fck	spacing	width	min provd		
-----+-- (kNm)-----+-- (kNm)-----+-- (mm)-----+-- (mm2)-----									
L end top	79.5	0.474	0.305	67.4	0.259	228.3	0.14	536	785
Midspan	41.9	0.638	0.098	35.6	0.083	321.8	0.26	62	311
R end top	85.9	0.680	0.361	72.9	0.306	243.4	0.21	482	559

-----+-----									
Beam: 12									
-----+-----									
Location	Characteristic loads G+Q			Quasi-permanent loads G+ψ2Q			Steel for		
	Moment	steel	concrete	Moment	concrete	Crack	cracking		
	stress/fyk	stress/fck		stress/fck	spacing	width	min provd		
-----+-- (kNm)-----+-- (kNm)-----+-- (mm)-----+-- (mm2)-----									
L end top	84.0	0.665	0.353	71.3	0.299	243.4	0.21	482	559

Midspan	41.8	0.637	0.098		35.5	0.083	321.8	0.26		62	311
R end top	84.0	0.665	0.353		71.3	0.299	243.4	0.21		482	559

Beam: 13

Location	Characteristic loads G+Q			Quasi-permanent loads G+ψ2Q			Steel for				
	Moment	steel	concrete	Moment	concrete	Crack	cracking				
	stress/fyk	stress/fck		stress/fck	spacing	width	min provd				
	(kNm)			(kNm)			(mm)	(mm2)			
L end top	85.9	0.680	0.361		72.9	0.306	243.4	0.21		482	559
Midspan	41.9	0.638	0.098		35.6	0.083	321.8	0.26		62	311
R end top	79.5	0.474	0.305		67.4	0.259	228.3	0.14		536	785

* STOREY: -1 * BEAMS: 10 11 12 13 14

* Concrete: C25 - Long. Reinforcement: S500 - Stirrups: S500 - Cover: 35 (mm) *

GEOMETRY - BENDING MOMENTS MED - LONGITUDINAL REINFORCEMENT

Beam: 10	Length l: 5.50m X-section InvL Depth h: 0.50m Width bw: 0.25m										
	Top flange thickness (m): 0.18 (L end) 0.18 (centre) 0.18 (R end)										
Location	Effect.	max MEd	Required	Beam bars	Provided	Flexural					
	fl width		steel area	Contin	Addit	steel area capacity					
	(m)	(kNm)	(mm2)	(mm2)		(kNm)					
L end top	0.25	104.9	580.	2Φ10	2Φ16	559. 101.4					
L end bot.	0.43	-68.8	149.	2Φ10	--	157. 30.2					
midspan	1.27	56.8	295.	2Φ10	1Φ14	311. 60.0					

R end top	0.25	101.7	561.	2Φ10	2Φ16	559.	101.4	
R end bot.	0.61	-65.3	149.	2Φ10	--	157.	30.3	
+-----+								
+-----+								
Beam:	11	Length l: 5.30m		X-section InvL		Depth h: 0.50m	Width bw: 0.25m	
-----+								
Top flange thickness (m): 0.18 (L end) 0.18 (centre) 0.18 (R end)								
-----+								
Location	Effect.	max MEd	Required	Beam bars	Provided	Flexural		
	fl width		steel area	Contin	Addit	steel area	capacity	
-----+	---(m)	---(kNm)	---(mm2)	---+	-----	---(mm2)	---+	---(kNm)---
L end top	0.25	105.0	580.	2Φ10	2Φ16	559.	101.4	
L end bot.	0.61	-65.9	149.	2Φ10	--	157.	30.3	
midspan	1.09	53.4	277.	2Φ10	1Φ14	311.	59.9	
R end top	0.25	108.4	601.	2Φ10	2Φ16	559.	101.4	
R end bot.	0.61	-68.3	149.	2Φ10	--	157.	30.3	
+-----+								
+-----+								
Beam:	12	Length l: 5.30m		X-section InvL		Depth h: 0.50m	Width bw: 0.25m	
-----+								
Top flange thickness (m): 0.18 (L end) 0.18 (centre) 0.18 (R end)								
-----+								
Location	Effect.	max MEd	Required	Beam bars	Provided	Flexural		
	fl width		steel area	Contin	Addit	steel area	capacity	
-----+	---(m)	---(kNm)	---(mm2)	---+	-----	---(mm2)	---+	---(kNm)---
L end top	0.25	107.9	598.	2Φ10	2Φ16	559.	101.4	
L end bot.	0.61	-68.4	149.	2Φ10	--	157.	30.3	
midspan	1.09	53.9	279.	2Φ10	1Φ14	311.	59.9	
R end top	0.25	107.9	598.	2Φ10	2Φ16	559.	101.4	
R end bot.	0.61	-68.4	149.	2Φ10	--	157.	30.3	
+-----+								
+-----+								
Beam:	13	Length l: 5.30m		X-section InvL		Depth h: 0.50m	Width bw: 0.25m	
-----+								
Top flange thickness (m): 0.18 (L end) 0.18 (centre) 0.18 (R end)								
-----+								
Location	Effect.	max MEd	Required	Beam bars	Provided	Flexural		
	fl width		steel area	Contin	Addit	steel area	capacity	
-----+	---(m)	---(kNm)	---(mm2)	---+	-----	---(mm2)	---+	---(kNm)---
L end top	0.25	108.4	601.	2Φ10	2Φ16	559.	101.4	
L end bot.	0.61	-68.3	149.	2Φ10	--	157.	30.3	
midspan	1.09	53.4	277.	2Φ10	1Φ14	311.	59.9	

R end top	0.25	105.0	580.	2Φ10	2Φ16	559.	101.4		
R end bot.	0.61	-65.9	149.	2Φ10	--	157.	30.3		
+-----+									
+-----+									
Beam:	14	Length l:	5.50m	X-section	InvL	Depth h:	0.50m	Width bw:	0.25m

Top flange thickness (m): 0.18 (L end) 0.18 (centre) 0.18 (R end)									

Location	Effect.	max MEd	Required	Beam bars	Provided	Flexural			
	fl width		steel area	Contin	Addit	steel area	capacity		
-----+	---+	---+	---+	---+	---+	---+	---+	---	
L end top	0.25	101.7	561.	2Φ10	2Φ16	559.	101.4		
L end bot.	0.61	-65.3	149.	2Φ10	--	157.	30.3		
midspan	1.27	56.8	295.	2Φ10	1Φ14	311.	60.0		
R end top	0.25	104.9	580.	2Φ10	2Φ16	559.	101.4		
R end bot.	0.43	-68.8	149.	2Φ10	--	157.	30.2		
+-----+									
+-----+									
SLS CHECKS: STRESS LIMITS, CRACK WIDTH CONTROL FOR Wmax=0.3mm & min STEEL AREA									
+-----+									
+-----+									
Beam:	10								

Location	Characteristic loads G+Q	Quasi-permanent loads G+ψ2Q	Steel for						
	Moment steel	concrete	Moment concrete	Crack	cracking				
	stress/fyk	stress/fck	stress/fck	spacing	width	min provd			
-----+	---+	---+	---+	---+	---+	---+	---+	---	
L end top	81.6	0.691	0.350	69.3	0.297	252.2	0.22	395 559	
Midspan	44.2	0.671	0.096	37.5	0.081	321.8	0.27	62 311	
R end top	79.2	0.671	0.340	67.1	0.288	244.9	0.21	482 559	
+-----+									
+-----+									
Beam:	11								

Location	Characteristic loads G+Q	Quasi-permanent loads G+ψ2Q	Steel for						
	Moment steel	concrete	Moment concrete	Crack	cracking				
	stress/fyk	stress/fck	stress/fck	spacing	width	min provd			
-----+	---+	---+	---+	---+	---+	---+	---+	---	
L end top	81.7	0.646	0.343	69.3	0.291	243.4	0.20	482 559	
Midspan	41.6	0.633	0.098	35.3	0.083	321.8	0.26	62 311	
R end top	84.4	0.668	0.354	71.6	0.301	243.4	0.21	482 559	
+-----+									
+-----+									
Beam:	12								

+-----+									

Location	Characteristic loads G+Q			Quasi-permanent loads G+ψ2Q				Steel for	
	Moment	steel	concrete	Moment	concrete	Crack		cracking	
	stress/fyk	stress/fck		stress/fck	spacing	width	min	provd	
	(kNm)			(kNm)	(mm)		(mm ²)		
L end top	83.9	0.664	0.352	71.2	0.299	243.4	0.21	482	559
Midspan	41.9	0.639	0.098	35.6	0.083	321.8	0.26	62	311
R end top	83.9	0.664	0.352	71.2	0.299	243.4	0.21	482	559

Beam: 13

Location	Characteristic loads G+Q			Quasi-permanent loads G+ψ2Q				Steel for	
	Moment	steel	concrete	Moment	concrete	Crack		cracking	
	stress/fyk	stress/fck		stress/fck	spacing	width	min	provd	
	(kNm)			(kNm)	(mm)		(mm ²)		
L end top	84.4	0.668	0.354	71.6	0.301	243.4	0.21	482	559
Midspan	41.6	0.633	0.098	35.3	0.083	321.8	0.26	62	311
R end top	81.7	0.646	0.343	69.3	0.291	243.4	0.20	482	559

Beam: 14

Location	Characteristic loads G+Q			Quasi-permanent loads G+ψ2Q				Steel for	
	Moment	steel	concrete	Moment	concrete	Crack		cracking	
	stress/fyk	stress/fck		stress/fck	spacing	width	min	provd	
	(kNm)			(kNm)	(mm)		(mm ²)		
L end top	79.2	0.626	0.332	67.1	0.282	243.4	0.19	482	559
Midspan	44.2	0.671	0.096	37.5	0.081	321.8	0.27	62	311
R end top	81.6	0.645	0.342	69.3	0.291	250.7	0.21	395	559

3A 1.4 FRAME 1

```

*-----*
* STOREY: 6 * BEAMS: 22 21
*-----*
* Concrete: C25 - Long. Reinforcement: S500 - Stirrups: S500 - Cover: 35 (mm) *
*-----*
          GEOMETRY - BENDING MOMENTS MED - LONGITUDINAL REINFORCEMENT
*-----*
|Beam: 22|Length l: 4.65m|X-section InvL | Depth h: 0.50m| Width bw: 0.25m |

```

-----+-----							
Top flange thickness (m): 0.18 (L end) 0.18 (centre) 0.18 (R end)							
-----+-----							
Location	Effect.	max MEd	Required	Beam bars	Provided	Flexural	
fl width			steel area	Contin Addit	steel area	capacity	
-----+-- (m) ---+-- (kNm) ---+-- (mm2) ---+-----+-- (mm2) ---+-- (kNm) ---							
L end top	0.25	186.7	1108.	2Φ14 6Φ12	1083.	188.3	
L end bot.	0.46	151.6	824.	2Φ14 2Φ20	936.	170.8	
midspan	1.44	23.3	287.	2Φ14 --	308.	59.5	
R end top	0.25	228.9	1420.	2Φ14 8Φ12	1399.	245.3	
R end bot.	0.67	157.9	845.	2Φ14 2Φ20	936.	174.3	
Note: Top reinforcements include 250mm ² /m of EC8s eff. slab width in tension							

-----+-----
 +-----+-----
 |Beam: 21|Length l: 4.65m|X-section InvL | Depth h: 0.50m| Width bw: 0.25m |

-----+-----							
Top flange thickness (m): 0.18 (L end) 0.18 (centre) 0.18 (R end)							
-----+-----							
Location	Effect.	max MEd	Required	Beam bars	Provided	Flexural	
fl width			steel area	Contin Addit	steel area	capacity	
-----+-- (m) ---+-- (kNm) ---+-- (mm2) ---+-----+-- (mm2) ---+-- (kNm) ---							
L end top	0.25	226.0	1397.	2Φ14 8Φ12	1399.	245.3	
L end bot.	0.67	160.0	856.	2Φ14 2Φ20	936.	174.3	
midspan	1.44	23.6	287.	2Φ14 --	308.	59.5	
R end top	0.25	188.5	1121.	2Φ14 6Φ12	1083.	188.3	
R end bot.	0.46	149.0	810.	2Φ14 2Φ20	936.	170.8	
Note: Top reinforcements include 250mm ² /m of EC8s eff. slab width in tension							

-----+-----
 +-----+-----
 SLS CHECKS: STRESS LIMITS, CRACK WIDTH CONTROL FOR W_{max}=0.3mm & min STEEL AREA

-----+-----
 +-----+-----
 |Beam: 22 |

-----+-----							
Location	Characteristic loads G+Q			Quasi-permanent loads G+ψ ₂ Q			Steel for
	Moment	steel	concrete	Moment	concrete	Crack	cracking
	stress/fyk	stress/fck		stress/fck	spacing	width	min provd
-----+-- (kNm) ---+-----+-- (kNm) ---+-----+-- (mm) ---+-- (mm2) ---							
L end top	20.6	0.102	0.055	17.6	0.047	201.4	0.03 299 986
Midspan	18.2	0.278	0.037	15.4	0.031	359.1	0.13 62 307
R end top	41.9	0.171	0.107	35.5	0.091	187.4	0.04 293 1212

-----+-----
 +-----+-----
 |Beam: 21 |

Location	Characteristic loads G+Q			Quasi-permanent loads G+ψ2Q				Steel for	
	Moment	steel	concrete	Moment	concrete	Crack	cracking		
	stress/fyk	stress/fck		stress/fck	spacing	width	min provd		
	(kNm)			(kNm)		(mm)	(mm2)		
L end top	39.0	0.153	0.099	33.0	0.083	187.0	0.04	293	1212
Midspan	18.3	0.280	0.037	15.6	0.031	359.1	0.13	62	307
R end top	23.2	0.109	0.062	19.7	0.052	200.8	0.03	299	986

JOINT GEOMETRY - SHEAR FORCES - VERIFICATION IN SHEAR

Joint	Max Φ	J width	J hor. shear	J hor. shear	J hor. steel	J ver. steel
		bj	Vjh	strength	area Ash	area Asv
	(mm)	(m)	(kN)	(kN)	(mm2)	(mm2)
1	30	0.30	0.	1415.	0.	0.
2	176	0.30	0.	10378.	0.	0.
3	30	0.30	0.	1413.	0.	0.

* STOREY: 5 * BEAMS: 22 21

* Concrete: C25 - Long. Reinforcement: S500 - Stirrups: S500 - Cover: 35 (mm) *

GEOMETRY - BENDING MOMENTS MED - LONGITUDINAL REINFORCEMENT

Beam:	22	Length l:	4.65m	X-section InvL	Depth h:	0.50m	Width bw:	0.25m
Top flange thickness (m): 0.18 (L end) 0.18 (centre) 0.18 (R end)								
Location	Effect.	max MEd	Required	Beam bars	Provided	Flexural		
	fl width		steel area	Contin	Addit	steel area	capacity	
	(m)	(kNm)	(mm2)			(mm2)	(kNm)	
L end top	0.25	228.3	1415.	2Φ14	3Φ20	1347.	232.7	
L end bot.	0.46	185.4	1022.	2Φ14	3Φ20	1250.	223.2	
midspan	1.44	21.9	287.	2Φ14	--	308.	59.5	
R end top	0.25	247.6	1569.	2Φ14	4Φ18	1512.	263.4	
R end bot.	0.67	182.4	981.	2Φ14	3Φ20	1250.	229.4	

|Note: Top reinforcements include 250mm2/m of EC8s eff. slab width in tension |

Beam: 21 Length l: 4.65m X-section InvL Depth h: 0.50m Width bw: 0.25m							
-----+-----							
Top flange thickness (m): 0.18 (L end) 0.18 (centre) 0.18 (R end)							
-----+-----							
Location	Effect.	max MEd	Required	Beam bars	Provided	Flexural	
fl width			steel area	Contin Addit	steel area	capacity	
-----+-- (m) ----+-- (kNm) ----+-- (mm2) ----+-----+-- (mm2) ----+-- (kNm) --							
L end top	0.25	245.3	1551.	2Φ14 4Φ18	1512.	263.4	
L end bot.	0.67	183.6	989.	2Φ14 3Φ20	1250.	229.4	
midspan	1.44	22.0	287.	2Φ14 --	308.	59.5	
R end top	0.25	229.2	1422.	2Φ14 3Φ20	1347.	232.7	
R end bot.	0.46	183.6	1011.	2Φ14 3Φ20	1250.	223.2	
Note: Top reinforcements include 250mm ² /m of EC8s eff. slab width in tension							

SLS CHECKS: STRESS LIMITS, CRACK WIDTH CONTROL FOR W_{max}=0.3mm & min STEEL AREA

Beam: 22							
-----+-----							
Location	Characteristic loads G+Q		Quasi-permanent loads G+ψ2Q		Steel for		
	Moment	steel	concrete	Moment	concrete	Crack	cracking
		stress/fyk	stress/fck	stress/fck	spacing	width	min provd
-----+-- (kNm) ----+-----+-- (kNm) ----+-----+-- (mm) ----+-- (mm2) --							
L end top	25.2	0.099	0.058	21.4	0.049	208.2	0.03 377 1250
Midspan	17.1	0.261	0.035	14.5	0.029	359.1	0.12 62 307
R end top	38.7	0.144	0.088	32.6	0.074	198.1	0.04 374 1325

Beam: 21							
-----+-----							
Location	Characteristic loads G+Q		Quasi-permanent loads G+ψ2Q		Steel for		
	Moment	steel	concrete	Moment	concrete	Crack	cracking
		stress/fyk	stress/fck	stress/fck	spacing	width	min provd
-----+-- (kNm) ----+-----+-- (kNm) ----+-----+-- (mm) ----+-- (mm2) --							
L end top	36.5	0.131	0.082	30.8	0.069	197.7	0.03 374 1325
Midspan	17.1	0.262	0.035	14.5	0.029	359.1	0.12 62 307
R end top	27.0	0.102	0.061	22.8	0.052	207.6	0.03 377 1250

JOINT GEOMETRY - SHEAR FORCES - VERIFICATION IN SHEAR

Joint	Max Φ	J width	J hor. shear	J hor. shear	J hor. steel	J ver. steel
		bj	Vjh	strength	area Ash	area Asv

	(mm)	(m)	(kN)	(kN)	(mm ²)	(mm ²)
1	32	0.30	0.	1343.	0.	0.
2	178	0.30	0.	10199.	0.	0.
3	32	0.30	0.	1338.	0.	0.

-----*

* STOREY: 4 * BEAMS: 22 21

-----*

* Concrete: C25 - Long. Reinforcement: S500 - Stirrups: S500 - Cover: 35 (mm) *

-----*

GEOMETRY - BENDING MOMENTS MED - LONGITUDINAL REINFORCEMENT

Beam: 22 Length l: 4.65m X-section InvL Depth h: 0.50m Width bw: 0.25m							

Top flange thickness (m): 0.18 (L end) 0.18 (centre) 0.18 (R end)							

Location	Effect.	max MEd	Required	Beam bars	Provided	Flexural	
	fl width		steel area	Contin Addit	steel area	capacity	
-----	--- (m) ---	--- (kNm) ---	--- (mm ²) ---	-----	--- (mm ²) ---	--- (kNm) ---	
L end top	0.25	226.6	1402.	2Φ14 3Φ20	1347.	232.7	
L end bot.	0.46	184.3	1015.	2Φ14 3Φ20	1250.	223.2	
midspan	1.44	22.2	287.	2Φ14 --	308.	59.5	
R end top	0.25	249.6	1586.	2Φ14 4Φ18	1512.	263.4	
R end bot.	0.67	182.9	985.	2Φ14 3Φ20	1250.	229.4	
Note: Top reinforcements include 250mm ² /m of EC8s eff. slab width in tension							

Beam: 21 Length l: 4.65m X-section InvL Depth h: 0.50m Width bw: 0.25m							

Top flange thickness (m): 0.18 (L end) 0.18 (centre) 0.18 (R end)							

Location	Effect.	max MEd	Required	Beam bars	Provided	Flexural	
	fl width		steel area	Contin Addit	steel area	capacity	
-----	--- (m) ---	--- (kNm) ---	--- (mm ²) ---	-----	--- (mm ²) ---	--- (kNm) ---	
L end top	0.25	246.6	1561.	2Φ14 4Φ18	1512.	263.4	
L end bot.	0.67	184.8	995.	2Φ14 3Φ20	1250.	229.4	
midspan	1.44	22.3	287.	2Φ14 --	308.	59.5	
R end top	0.25	228.4	1416.	2Φ14 3Φ20	1347.	232.7	
R end bot.	0.46	181.4	998.	2Φ14 3Φ20	1250.	223.2	
Note: Top reinforcements include 250mm ² /m of EC8s eff. slab width in tension							

-----+
 SLS CHECKS: STRESS LIMITS, CRACK WIDTH CONTROL FOR Wmax=0.3mm & min STEEL AREA
 -----+

Location	Characteristic loads G+Q			Quasi-permanent loads G+ψ2Q			Steel for	
	Moment	steel	concrete	Moment	concrete	Crack	cracking	
	stress/fyk	stress/fyk	stress/fck	stress/fck	spacing	width	min provd	
	(kNm)			(kNm)		(mm)	(mm2)	
L end top	24.9	0.098	0.057	21.2	0.049	208.2	0.03	377 1250
Midspan	17.3	0.264	0.035	14.7	0.030	359.1	0.12	62 307
R end top	39.4	0.147	0.089	33.3	0.076	198.1	0.04	374 1325

Location	Characteristic loads G+Q			Quasi-permanent loads G+ψ2Q			Steel for	
	Moment	steel	concrete	Moment	concrete	Crack	cracking	
	stress/fyk	stress/fyk	stress/fck	stress/fck	spacing	width	min provd	
	(kNm)			(kNm)		(mm)	(mm2)	
L end top	36.5	0.132	0.082	30.9	0.069	197.7	0.03	374 1325
Midspan	17.4	0.266	0.035	14.7	0.030	359.1	0.12	62 307
R end top	27.6	0.105	0.063	23.5	0.053	207.6	0.03	377 1250

-----+
 JOINT GEOMETRY - SHEAR FORCES - VERIFICATION IN SHEAR
 -----+

Joint	Max Φ	J width	J hor. shear	J hor. shear	J hor. steel	J ver. steel
		bj	Vjh	strength	area Ash	area Asv
	(mm)	(m)	(kN)	(kN)	(mm2)	(mm2)
1	32	0.30	0.	1268.	0.	0.
2	180	0.30	0.	10017.	0.	0.
3	30	0.30	0.	1258.	0.	0.

-----*
 * STOREY: 3 * BEAMS: 22 21
 -----*
 * Concrete: C25 - Long. Reinforcement: S500 - Stirrups: S500 - Cover: 35 (mm) *
 -----*

GEOMETRY - BENDING MOMENTS MED - LONGITUDINAL REINFORCEMENT

-----+
 |Beam: 22|Length l: 4.65m|X-section InvL | Depth h: 0.50m| Width bw: 0.25m |
 -----+

-----+-----							
Top flange thickness (m): 0.18 (L end) 0.18 (centre) 0.18 (R end)							
-----+-----							
Location	Effect.	max MEd	Required	Beam bars	Provided	Flexural	
fl width			steel area	Contin Addit	steel area	capacity	
-----+-- (m)-----+-- (kNm)-----+-- (mm2)-----+-- (mm2)-----+-- (kNm)-----							
L end top	0.25	223.0	1374.	2Φ14 3Φ20	1347.	232.7	
L end bot.	0.46	179.0	984.	2Φ14 3Φ20	1250.	223.2	
midspan	1.44	22.2	287.	2Φ14 --	308.	59.5	
R end top	0.25	242.9	1531.	2Φ14 3Φ20	1437.	251.8	
R end bot.	0.67	177.9	956.	2Φ14 2Φ20	936.	174.3	
Note: Top reinforcements include 250mm ² /m of EC8s eff. slab width in tension							

+-----+-----+
+-----+-----+
|Beam: 21|Length l: 4.65m|X-section InvL | Depth h: 0.50m| Width bw: 0.25m |

-----+-----							
Top flange thickness (m): 0.18 (L end) 0.18 (centre) 0.18 (R end)							
-----+-----							
Location	Effect.	max MEd	Required	Beam bars	Provided	Flexural	
fl width			steel area	Contin Addit	steel area	capacity	
-----+-- (m)-----+-- (kNm)-----+-- (mm2)-----+-- (mm2)-----+-- (kNm)-----							
L end top	0.25	240.1	1509.	2Φ14 3Φ20	1437.	251.8	
L end bot.	0.67	179.5	966.	2Φ14 2Φ20	936.	174.3	
midspan	1.44	22.3	287.	2Φ14 --	308.	59.5	
R end top	0.25	224.6	1386.	2Φ14 3Φ20	1347.	236.2	
R end bot.	0.46	176.4	969.	2Φ14 2Φ20	936.	170.8	
Note: Top reinforcements include 250mm ² /m of EC8s eff. slab width in tension							

+-----+-----+
+-----+-----+
SLS CHECKS: STRESS LIMITS, CRACK WIDTH CONTROL FOR W_{max}=0.3mm & min STEEL AREA

+-----+-----+
+-----+-----+
|Beam: 22 |

-----+-----+-----+-----							
Location	Characteristic loads G+Q			Quasi-permanent loads G+ψ ₂ Q			Steel for
	Moment	steel	concrete	Moment	concrete	Crack	cracking
	stress/fyk	stress/fck		stress/fck	spacing	width	min provd
-----+-- (kNm)-----+-- (kNm)-----+-- (mm)-----+-- (mm2)-----							
L end top	25.9	0.102	0.059	22.0	0.051	208.2	0.03 377 1250
Midspan	17.3	0.264	0.035	14.7	0.030	359.1	0.12 62 307
R end top	38.4	0.152	0.097	32.5	0.082	203.9	0.04 388 1250

+-----+-----+
+-----+-----+
|Beam: 21 |

Location	Characteristic loads G+Q			Quasi-permanent loads G+ψ2Q			Steel for	
	Moment	steel	concrete	Moment	concrete	Crack	cracking	
	stress/fyk	stress/fck		stress/fck	spacing	width	min provd	
	(kNm)			(kNm)			(mm)	
L end top	35.8	0.137	0.090	30.3	0.076	203.3	0.04	388 1250
Midspan	17.4	0.265	0.035	14.7	0.030	359.1	0.12	62 307
R end top	28.3	0.108	0.071	24.1	0.060	205.7	0.03	377 1250

JOINT GEOMETRY - SHEAR FORCES - VERIFICATION IN SHEAR

Joint	Max Φ	J width	J hor. shear	J hor. shear	J hor. steel	J ver. steel
		bj	Vjh	strength	area Ash	area Asv
	(mm)	(m)	(kN)	(kN)	(mm2)	(mm2)
1	30	0.30	0.	1188.	0.	0.
2	182	0.30	0.	9832.	0.	0.
3	30	0.30	0.	1173.	0.	0.

* STOREY: 2 * BEAMS: 22 21

* Concrete: C25 - Long. Reinforcement: S500 - Stirrups: S500 - Cover: 35 (mm) *

GEOMETRY - BENDING MOMENTS MED - LONGITUDINAL REINFORCEMENT

Beam:	22	Length l:	4.65m	X-section InvL	Depth h:	0.50m	Width bw:	0.25m
Top flange thickness (m): 0.18 (L end) 0.18 (centre) 0.18 (R end)								
Location	Effect.	max MEd	Required	Beam bars	Provided	Flexural		
	fl width		steel area	Contin	Addit	steel area	capacity	
	(m)	(kNm)	(mm2)	(mm2)		(kNm)		
L end top	0.25	202.2	1218.	2Φ14	3Φ18	1168.	204.1	
L end bot.	0.46	155.6	848.	2Φ14	2Φ20	936.	170.8	
midspan	1.44	22.2	287.	2Φ14	--	308.	59.5	
R end top	0.25	218.1	1336.	2Φ14	3Φ18	1258.	220.4	
R end bot.	0.67	155.4	831.	2Φ14	2Φ20	936.	174.3	

|Note: Top reinforcements include 250mm2/m of EC8s eff. slab width in tension |

Location	Effect.	max MEd	Required	Beam bars	Provided	Flexural
fl width			steel area	Contin Addit	steel area	capacity
--- (m) ---	--- (kNm) ---	--- (mm ²) ---	--- (mm ²) ---	--- (mm ²) ---	--- (kNm) ---	
L end top	0.25	215.8	1319.	2Φ14 3Φ18	1258.	220.4
L end bot.	0.67	156.8	838.	2Φ14 2Φ20	936.	174.3
midspan	1.44	22.2	287.	2Φ14 --	308.	59.5
R end top	0.25	203.5	1228.	2Φ14 3Φ18	1168.	204.1
R end bot.	0.46	153.5	835.	2Φ14 2Φ20	936.	170.8

| Note: Top reinforcements include 250mm²/m of EC8s eff. slab width in tension |

SLS CHECKS: STRESS LIMITS, CRACK WIDTH CONTROL FOR Wmax=0.3mm & min STEEL AREA

Location	Characteristic loads G+Q	Quasi-permanent loads G+ψ2Q	Steel for
Moment	steel	concrete	cracking
stress/fyk	stress/fck	stress/fck	spacing width
--- (kNm) ---	--- (kNm) ---	--- (kNm) ---	--- (mm) ---
L end top	27.3	0.125	0.072
Midspan	17.3	0.264	0.035
R end top	37.0	0.169	0.097

Location	Characteristic loads G+Q	Quasi-permanent loads G+ψ2Q	Steel for
Moment	steel	concrete	cracking
stress/fyk	stress/fck	stress/fck	spacing width
--- (kNm) ---	--- (kNm) ---	--- (kNm) ---	--- (mm) ---
L end top	34.9	0.153	0.091
Midspan	17.3	0.265	0.035
R end top	29.4	0.128	0.076

JOINT GEOMETRY - SHEAR FORCES - VERIFICATION IN SHEAR

Joint	Max Φ	J width	J hor. shear	J hor. shear	J hor. steel	J ver. steel
		bj	Vjh	strength	area Ash	area Asv

-----+
 SLS CHECKS: STRESS LIMITS, CRACK WIDTH CONTROL FOR Wmax=0.3mm & min STEEL AREA
 -----+

Beam: 22									
-----+									
Location	Characteristic loads G+Q			Quasi-permanent loads G+ψ2Q			Steel for		
	Moment	steel	concrete	Moment	concrete	Crack	cracking		
	stress/fyk		stress/fck	stress/fck		spacing	width	min provd	
	-- (kNm) -----			-- (kNm) -----			(mm) -----	-- (mm2) --	
L end top	27.4	0.161	0.086	23.3	0.074	232.1	0.05	358	816
Midspan	17.7	0.270	0.036	15.0	0.030	359.1	0.12	62	307
R end top	36.1	0.213	0.114	30.6	0.096	227.2	0.06	366	816

Beam: 21									
-----+									
Location	Characteristic loads G+Q			Quasi-permanent loads G+ψ2Q			Steel for		
	Moment	steel	concrete	Moment	concrete	Crack	cracking		
	stress/fyk		stress/fck	stress/fck		spacing	width	min provd	
	-- (kNm) -----			-- (kNm) -----			(mm) -----	-- (mm2) --	
L end top	34.6	0.193	0.108	29.3	0.091	226.1	0.06	366	816
Midspan	17.7	0.271	0.036	15.0	0.030	359.1	0.12	62	307
R end top	28.8	0.161	0.089	24.5	0.076	231.0	0.05	358	816

-----+
 JOINT GEOMETRY - SHEAR FORCES - VERIFICATION IN SHEAR
 -----+

Joint	Max Φ	J width	J hor. shear	J hor. shear	J hor. steel	J ver. steel
		b _j	V _{jh}	strength	area A _{sh}	area A _{sv}
	(mm)	(m)	(kN)	(kN)	(mm ²)	(mm ²)
1	32	0.30	0.	1032.	0.	0.
2	186	0.30	0.	9462.	0.	0.
3	30	0.30	0.	1004.	0.	0.

3A 1.5 FRAME 2

-----*
 * STOREY: 6 * BEAMS: 28 27
 -----*
 * Concrete: C25 - Long. Reinforcement: S500 - Stirrups: S500 - Cover: 35 (mm) *
 -----*

GEOMETRY - BENDING MOMENTS MED - LONGITUDINAL REINFORCEMENT

+-----+

|Beam: 28|Length l: 6.60m|X-section T | Depth h: 0.50m| Width bw: 0.25m |

|-----|

| |Top flange thickness (m): 0.18 (L end) 0.18 (centre) 0.18 (R end)|

|-----|

Location	Effect.	max MED	Required	Beam bars	Provided	Flexural
	fl width		steel area	Contin Addit	steel area	capacity
	---(m)---	---(kNm)---	---(mm2)---		---(mm2)---	---(kNm)---
L end top	0.25	118.6	663.	2Φ14 --	713.	126.8
L end bot.	0.67	-8.0	331.	2Φ14 --	308.	59.0
midspan	2.63	112.2	581.	2Φ14 2Φ14	616.	118.8
R end top	0.25	181.6	1072.	2Φ14 1Φ20	1045.	184.5
R end bot.	1.09	-53.5	536.	2Φ14 --	616.	117.6

|-----|

|L end top | 0.25 | 118.6 | 663. | 2Φ14 -- | 713. | 126.8 |

|L end bot. | 0.67 | -8.0 | 331. | 2Φ14 -- | 308. | 59.0 |

|midspan | 2.63 | 112.2 | 581. | 2Φ14 2Φ14| 616. | 118.8 |

|R end top | 0.25 | 181.6 | 1072. | 2Φ14 1Φ20| 1045. | 184.5 |

|R end bot. | 1.09 | -53.5 | 536. | 2Φ14 -- | 616. | 117.6 |

|Note: Top reinforcements include 250mm²/m of EC8s eff. slab width in tension |

|Note:1. Addit. bot. midspan bars extended: 2Φ14 to Right end. |

| 2. Addit. bot. midspan bars extended to Left end of beam 2: 2Φ14 |

|-----|

+-----+

|Beam: 27|Length l: 6.60m|X-section T | Depth h: 0.50m| Width bw: 0.25m |

|-----|

| |Top flange thickness (m): 0.18 (L end) 0.18 (centre) 0.18 (R end)|

|-----|

Location	Effect.	max MED	Required	Beam bars	Provided	Flexural
	fl width		steel area	Contin Addit	steel area	capacity
	---(m)---	---(kNm)---	---(mm2)---		---(mm2)---	---(kNm)---
L end top	0.25	184.1	1090.	2Φ14 1Φ20	1045.	184.5
L end bot.	1.09	-57.3	545.	2Φ14 --	616.	117.6
midspan	2.63	111.8	579.	2Φ14 2Φ14	616.	118.8
R end top	0.25	115.4	643.	2Φ14 --	600.	108.3
R end bot.	0.67	-5.6	322.	2Φ14 --	308.	59.0

|-----|

|L end top | 0.25 | 184.1 | 1090. | 2Φ14 1Φ20| 1045. | 184.5 |

|L end bot. | 1.09 | -57.3 | 545. | 2Φ14 -- | 616. | 117.6 |

|midspan | 2.63 | 111.8 | 579. | 2Φ14 2Φ14| 616. | 118.8 |

|R end top | 0.25 | 115.4 | 643. | 2Φ14 -- | 600. | 108.3 |

|R end bot. | 0.67 | -5.6 | 322. | 2Φ14 -- | 308. | 59.0 |

|Note: Top reinforcements include 250mm²/m of EC8s eff. slab width in tension |

|Note:1. Addit. bot. midspan bars of beam 2 ext. to L end of beam 1: 2Φ14|

|-----|

+-----+

+-----+

SLS CHECKS: STRESS LIMITS, CRACK WIDTH CONTROL FOR W_{max}=0.3mm & min STEEL AREA

+-----+

|Beam: 28 |

+-----+

Location	Characteristic loads G+Q	Quasi-permanent loads G+ψ2Q	Steel for
	Moment steel	concrete	Moment concrete
			Crack cracking

|-----|

|Location | Characteristic loads G+Q | Quasi-permanent loads G+ψ2Q | Steel for|

| |Moment steel | concrete |Moment concrete | Crack | cracking|

	stress/fyk	stress/fck	stress/fck	spacing	width	min	provd
	(kNm)	(kNm)	(kNm)	(mm)	(mm)	(mm)	(mm)
L end top	74.5	0.717	0.312	63.3	0.265	271.0	0.25 203 420
Midspan	87.3	0.668	0.093	74.0	0.079	262.4	0.22 62 615
R end top	138.6	0.970	0.463	117.5	0.392	240.7	0.30 370 622

Beam: 27

Location	Characteristic loads G+Q	Quasi-permanent loads G+ψ2Q	Steel for
	Moment steel	concrete	Moment concrete
	stress/fyk	stress/fck	stress/fck
	(kNm)	(kNm)	(kNm)
L end top	142.4	0.876	0.456
Midspan	87.0	0.666	0.093
R end top	71.3	0.696	0.300

JOINT GEOMETRY - SHEAR FORCES - VERIFICATION IN SHEAR

Joint	Max Φ	J width	J hor. shear	J hor. shear	J hor. steel	J ver. steel
		bj	Vjh	strength	area Ash	area Asv
	(mm)	(m)	(kN)	(kN)	(mm ²)	(mm ²)
1	14	0.40	0.	799.	0.	0.
2	22	0.50	0.	2013.	0.	0.
3	14	0.40	0.	799.	0.	0.

* STOREY: 5 * BEAMS: 28 27

* Concrete: C25 - Long. Reinforcement: S500 - Stirrups: S500 - Cover: 35 (mm) *

GEOMETRY - BENDING MOMENTS MED - LONGITUDINAL REINFORCEMENT

Beam	Length l	X-section	Depth h	Width bw		
28	6.60m	T	0.50m	0.25m		
Top flange thickness (m): 0.18 (L end) 0.18 (centre) 0.18 (R end)						
Location	Effect.	max MEd	Required	Beam bars	Provided	Flexural
	fl width	(kNm)	steel area	Contin	Addit	steel area
	(m)	(kNm)	(mm ²)	(mm ²)	(mm ²)	(kNm)
L end top	0.25	186.3	1105.	2Φ14	3Φ14	1062. 187.6

L end bot.	0.67	-4.0	553.	2Φ14	--	616.	116.4
midspan	2.63	100.0	518.	2Φ14	2Φ14	616.	118.8
R end top	0.25	200.5	1206.	2Φ14	3Φ14	1192.	209.8
R end bot.	1.09	-2.8	603.	2Φ14	--	616.	117.6

|Note: Top reinforcements include 250mm²/m of EC8s eff. slab width in tension |

|Note:1. Addit. bot. midspan bars extended: 2Φ14 to L end - 2Φ14 to R end |

| 2. Addit. bot. midspan bars extended to Left end of beam 2: 2Φ14 |

-----+-----

|Beam: 27|Length l: 6.60m|X-section T | Depth h: 0.50m| Width bw: 0.25m |

-----+-----

| |Top flange thickness (m): 0.18 (L end) 0.18 (centre) 0.18 (R end)|

-----+-----

Location	Effect.	max MEd	Required	Beam bars	Provided	Flexural	
	fl width		steel area	Contin	Addit	steel area	capacity
-----+--	(m) ----	+-- (kNm) ---	+-- (mm ²) ---	+-----+--	(mm ²) ----	+-- (kNm) --	
L end top	0.25	204.6	1236.	2Φ14	3Φ14	1192.	209.8
L end bot.	1.09	-8.5	618.	2Φ14	--	616.	117.6
midspan	2.63	99.7	516.	2Φ14	2Φ14	616.	118.8
R end top	0.25	181.2	1069.	2Φ14	3Φ14	1062.	187.6
R end bot.	0.67	-0.1	535.	2Φ14	--	616.	116.4

|Note: Top reinforcements include 250mm²/m of EC8s eff. slab width in tension |

|Note:1. Addit. bot. midspan bars extended: 2Φ14 to Right end. |

| 2. Addit. bot. midspan bars of beam 2 ext. to L end of beam 1: 2Φ14 |

-----+-----

SLS CHECKS: STRESS LIMITS, CRACK WIDTH CONTROL FOR W_{max}=0.3mm & min STEEL AREA

-----+-----

|Beam: 28 |

-----+-----

Location	Characteristic loads G+Q	Quasi-permanent loads G+ψ ₂ Q	Steel for						
	Moment steel	concrete	Moment concrete						
	stress/fyk	stress/fck	stress/fck						
			spacing width						
-----+--	(kNm) ----	(kNm) ----	(mm) ----						
L end top	112.1	0.657	0.354	95.1	0.301	219.6	0.18	215	769
Midspan	77.8	0.596	0.083	66.0	0.070	262.4	0.20	62	615
R end top	120.0	0.703	0.379	101.7	0.321	211.7	0.19	302	769

-----+-----

|Beam: 27 |

-----+-----

Location	Characteristic loads G+Q	Quasi-permanent loads G+ψ ₂ Q	Steel for
	Moment steel	concrete	Moment concrete
	stress/fyk	stress/fck	stress/fck
			spacing width
-----+--	(kNm) ----	(kNm) ----	(mm) ----

	stress/fyk	stress/fck	stress/fck	spacing	width	min	provd
	(kNm)	(kNm)	(kNm)	(mm)	(mm ²)		
L end top	125.7	0.661	0.384	106.6	0.326	210.1	0.18 302 769
Midspan	77.6	0.594	0.083	65.8	0.070	262.4	0.20 62 615
R end top	106.8	0.562	0.327	90.6	0.277	217.7	0.16 215 769

JOINT GEOMETRY - SHEAR FORCES - VERIFICATION IN SHEAR

Joint	Max Φ	J width	J hor. shear	J hor. shear	J hor. steel	J ver. steel
		bj	Vjh	strength	area Ash	area Asv
	(mm)	(m)	(kN)	(kN)	(mm ²)	(mm ²)
1	14	0.40	0.	747.	0.	0.
2	24	0.50	0.	1824.	0.	0.
3	14	0.40	0.	749.	0.	0.

* STOREY: 4 * BEAMS: 28 27

* Concrete: C25 - Long. Reinforcement: S500 - Stirrups: S500 - Cover: 35 (mm) *

GEOMETRY - BENDING MOMENTS MED - LONGITUDINAL REINFORCEMENT

Location	Effect.	max MEd	Required	Beam bars	Provided	Flexural
	fl width	(kNm)	steel area	Contin	Addit	steel area capacity
	(m)	(kNm)	(mm ²)	(mm ²)	(mm ²)	(kNm)
L end top	0.25	179.2	1056.	2 Φ 14	3 Φ 14	1062. 187.6
L end bot.	0.67	-0.9	528.	2 Φ 14	--	616. 116.4
midspan	2.63	101.5	525.	2 Φ 14	2 Φ 14	616. 118.8
R end top	0.25	201.7	1215.	2 Φ 14	3 Φ 14	1192. 209.8
R end bot.	1.09	-7.9	607.	2 Φ 14	--	616. 117.6

|Note: Top reinforcements include 250mm²/m of EC8s eff. slab width in tension |

|Note:1. Addit. bot. midspan bars extended: 2 Φ 14 to L end - 2 Φ 14 to R end |

| 2. Addit. bot. midspan bars extended to Left end of beam 2: 2 Φ 14 |

|Beam: 27|Length l: 6.60m|X-section T | Depth h: 0.50m| Width bw: 0.25m |

-----+-----							
Top flange thickness (m): 0.18 (L end) 0.18 (centre) 0.18 (R end)							
-----+-----							
Location	Effect.	max MEd	Required	Beam bars	Provided	Flexural	
	fl width		steel area	Contin Addit	steel area	capacity	
-----+-- (m)-----		---+--- (kNm)---	+--- (mm2)---	+-----+-- (mm2)---	---+--- (kNm)---		
L end top	0.25	205.7	1244.	2Φ14 3Φ14	1192.	209.8	
L end bot.	1.09	-13.4	622.	2Φ14 --	616.	117.6	
midspan	2.63	101.2	524.	2Φ14 2Φ14	616.	118.8	
R end top	0.25	175.6	1031.	2Φ14 4Φ12	1053.	186.0	
R end bot.	0.67	1.5	516.	2Φ14 --	616.	116.4	
Note: Top reinforcements include 250mm ² /m of EC8s eff. slab width in tension							
Note:1. Addit. bot. midspan bars extended: 2Φ14 to Right end.							
2. Addit. bot. midspan bars of beam 2 ext. to L end of beam 1: 2Φ14							

-----+-----
SLS CHECKS: STRESS LIMITS, CRACK WIDTH CONTROL FOR W_{max}=0.3mm & min STEEL AREA
-----+-----

-----+-----							
Beam: 28							
-----+-----							
Location	Characteristic loads G+Q			Quasi-permanent loads G+ψ2Q			Steel for
	Moment	steel	concrete	Moment	concrete	Crack	cracking
	stress/fyk	stress/fck		stress/fck	spacing	width	min provd
-----+-- (kNm)-----		-----+-- (kNm)---	-----+-- (kNm)---	-----+-- (kNm)---	-----+-- (mm)-----	-----+-- (mm2)---	
L end top	106.1	0.622	0.335	90.1	0.285	219.6	0.17 215 769
Midspan	79.0	0.605	0.084	67.0	0.071	262.4	0.20 62 615
R end top	123.6	0.725	0.391	104.8	0.331	211.7	0.20 302 769

-----+-----							
Beam: 27							
-----+-----							
Location	Characteristic loads G+Q			Quasi-permanent loads G+ψ2Q			Steel for
	Moment	steel	concrete	Moment	concrete	Crack	cracking
	stress/fyk	stress/fck		stress/fck	spacing	width	min provd
-----+-- (kNm)-----		-----+-- (kNm)---	-----+-- (kNm)---	-----+-- (kNm)---	-----+-- (mm)-----	-----+-- (mm2)---	
L end top	129.2	0.680	0.395	109.6	0.335	210.1	0.18 302 769
Midspan	78.8	0.603	0.084	66.8	0.071	262.4	0.20 62 615
R end top	102.3	0.543	0.314	87.1	0.267	212.1	0.15 191 760

-----+-----
JOINT GEOMETRY - SHEAR FORCES - VERIFICATION IN SHEAR
-----+-----

Joint	Max Φ	J width	J hor. shear	J hor. shear	J hor. steel	J ver. steel
-------	-------	---------	--------------	--------------	--------------	--------------

	bj	Vjh	strength	area Ash	area Asv
-----+-(mm)-----	-----+(m)-----	-----+(kN)-----	-----+(kN)-----	-----+(mm2)-----	-----+(mm2)-----
1 14 0.40 0. 693. 0. 0.					
2 24 0.50 0. 1609. 0. 0.					
3 14 0.40 0. 696. 0. 0.					

-----*

* STOREY: 3 * BEAMS: 28 27

-----*

* Concrete: C25 - Long. Reinforcement: S500 - Stirrups: S500 - Cover: 35 (mm) *

-----*

GEOMETRY - BENDING MOMENTS MED - LONGITUDINAL REINFORCEMENT

-----+							
Beam:	28	Length l:	6.60m	X-section	T	Depth h:	0.50m
-----+							
Top flange thickness (m): 0.18 (L end) 0.18 (centre) 0.18 (R end)							
-----+							
Location	Effect.	max MEd	Required	Beam bars	Provided	Flexural	
	fl width		steel area	Contin Addit	steel area	capacity	
-----+---	-----+(m)-----	-----+(kNm)-----	-----+(mm2)-----	-----+(mm2)-----	-----+(mm2)-----	-----+(kNm)-----	-----
L end top	0.25	174.2	1022.	2Φ14 3Φ12	1062.	187.6	
L end bot.	0.67	-0.4	511.	2Φ14 --	616.	116.4	
midspan	2.63	101.1	523.	2Φ14 2Φ14	616.	118.8	
R end top	0.25	200.4	1205.	2Φ14 3Φ14	1192.	209.8	
R end bot.	1.09	-11.3	603.	2Φ14 --	616.	117.6	
Note: Top reinforcements include 250mm ² /m of EC8s eff. slab width in tension							
Note:1. Addit. bot. midspan bars extended: 2Φ14 to L end - 2Φ14 to R end							
2. Addit. bot. midspan bars extended to Left end of beam 2: 2Φ14							

-----+							
Beam:	27	Length l:	6.60m	X-section	T	Depth h:	0.50m
-----+							
Top flange thickness (m): 0.18 (L end) 0.18 (centre) 0.18 (R end)							
-----+							
Location	Effect.	max MEd	Required	Beam bars	Provided	Flexural	
	fl width		steel area	Contin Addit	steel area	capacity	
-----+---	-----+(m)-----	-----+(kNm)-----	-----+(mm2)-----	-----+(mm2)-----	-----+(mm2)-----	-----+(kNm)-----	-----
L end top	0.25	204.6	1236.	2Φ14 3Φ14	1192.	209.8	
L end bot.	1.09	-17.1	618.	2Φ14 --	616.	117.6	
midspan	2.63	100.9	522.	2Φ14 2Φ14	616.	118.8	
R end top	0.25	171.2	1001.	2Φ14 3Φ12	1062.	187.6	

|R end bot. | 0.67 | 1.4 | 501. | 2Φ14 -- | 616. | 116.4 |
|Note: Top reinforcements include 250mm²/m of EC8s eff. slab width in tension |
|Note:1. Addit. bot. midspan bars extended: 2Φ14 to Right end. |
| 2. Addit. bot. midspan bars of beam 2 ext. to L end of beam 1: 2Φ14|

-----+-----+-----+-----+-----+-----+-----+-----+-----+
SLS CHECKS: STRESS LIMITS, CRACK WIDTH CONTROL FOR W_{max}=0.3mm & min STEEL AREA

Beam: 28									
Location	Characteristic loads G+Q			Quasi-permanent loads G+ψ2Q			Steel for		
	Moment	steel	concrete	Moment	concrete	Crack	cracking		
	stress/fyk	stress/fck		stress/fck	spacing	width	min provd		
	-- (kNm)-----+-- (kNm)-----+-- (mm)-----+-- (mm ²)--								
L end top	103.2	0.605	0.326	87.3	0.276	226.5	0.17	242	769
Midspan	78.7	0.603	0.084	66.8	0.071	262.4	0.20	62	615
R end top	124.9	0.732	0.395	105.9	0.334	211.7	0.20	302	769

Beam: 27									
Location	Characteristic loads G+Q			Quasi-permanent loads G+ψ2Q			Steel for		
	Moment	steel	concrete	Moment	concrete	Crack	cracking		
	stress/fyk	stress/fck		stress/fck	spacing	width	min provd		
	-- (kNm)-----+-- (kNm)-----+-- (mm)-----+-- (mm ²)--								
L end top	130.7	0.688	0.400	110.8	0.339	210.1	0.18	302	769
Midspan	78.5	0.601	0.084	66.6	0.071	262.4	0.20	62	615
R end top	100.0	0.526	0.306	84.9	0.260	224.4	0.15	242	769

-----+-----+-----+-----+-----+-----+-----+-----+-----+
JOINT GEOMETRY - SHEAR FORCES - VERIFICATION IN SHEAR

Joint	Max Φ	J width	J hor. shear	J hor. shear	J hor. steel	J ver. steel	
		b _j	V _{jh}	strength	area A _{sh}	area A _{sv}	
		(mm)	(m)	(kN)	(kN)	(mm ²)	(mm ²)
1	14	0.40		0.	633.	0.	0.
2	26	0.50		0.	1358.	0.	0.
3	14	0.40		0.	638.	0.	0.

-----+-----+-----+-----+-----+-----+-----+-----+-----+
* STOREY: 2 * BEAMS: 28 27
-----+-----+-----+-----+-----+-----+-----+-----+-----+

* Concrete: C25 - Long. Reinforcement: S500 - Stirrups: S500 - Cover: 35 (mm) *

-----*

GEOMETRY - BENDING MOMENTS MED - LONGITUDINAL REINFORCEMENT

+-----+

|Beam: 28|Length l: 6.60m|X-section T | Depth h: 0.50m| Width bw: 0.25m |

|-----|

| |Top flange thickness (m): 0.18 (L end) 0.18 (centre) 0.18 (R end)|

|-----|

| Location |Effect. | max MEd | Required | Beam bars | Provided |Flexural|

| |fl width| |steel area |Contin Addit |steel area|capacity|

|-----+---(m)---+---(kNm)---+---(mm2)---+---(mm2)---+---(kNm)---|

|L end top | 0.25 | 167.4 | 976. | 2Φ14 3Φ12| 940. | 162.0 |

|L end bot. | 0.67 | -11.5 | 488. | 2Φ14 -- | 462. | 87.9 |

|midspan | 2.63 | 100.4 | 520. | 2Φ14 2Φ14| 616. | 118.8 |

|R end top | 0.25 | 191.7 | 1143. | 2Φ14 2Φ16| 1132. | 199.7 |

|R end bot. | 1.09 | -22.1 | 572. | 2Φ14 -- | 616. | 117.6 |

|Note: Top reinforcements include 250mm²/m of EC8s eff. slab width in tension |

|Note:1. Addit. bot. midspan bars extended: 1Φ14 to L end - 2Φ14 to R end |

| 2. Addit. bot. midspan bars extended to Left end of beam 2: 2Φ14 |

+-----+

+-----+

|Beam: 27|Length l: 6.60m|X-section T | Depth h: 0.50m| Width bw: 0.25m |

|-----|

| |Top flange thickness (m): 0.18 (L end) 0.18 (centre) 0.18 (R end)|

|-----|

| Location |Effect. | max MEd | Required | Beam bars | Provided |Flexural|

| |fl width| |steel area |Contin Addit |steel area|capacity|

|-----+---(m)---+---(kNm)---+---(mm2)---+---(mm2)---+---(kNm)---|

|L end top | 0.25 | 193.2 | 1154. | 2Φ14 2Φ16| 1132. | 199.7 |

|L end bot. | 1.09 | -25.1 | 577. | 2Φ14 -- | 616. | 117.6 |

|midspan | 2.63 | 100.0 | 518. | 2Φ14 2Φ14| 616. | 118.8 |

|R end top | 0.25 | 162.0 | 940. | 2Φ14 2Φ14| 908. | 157.3 |

|R end bot. | 0.67 | -7.4 | 470. | 2Φ14 -- | 462. | 87.9 |

|Note: Top reinforcements include 250mm²/m of EC8s eff. slab width in tension |

|Note:1. Addit. bot. midspan bars extended: 1Φ14 to Right end. |

| 2. Addit. bot. midspan bars of beam 2 ext. to L end of beam 1: 2Φ14|

+-----+

+-----+

SLS CHECKS: STRESS LIMITS, CRACK WIDTH CONTROL FOR Wmax=0.3mm & min STEEL AREA

+-----+

|Beam: 28 |

+-----+

Location	Characteristic loads G+Q			Quasi-permanent loads G+ψ2Q				Steel for	
	Moment	steel	concrete	Moment	concrete	Crack		cracking	
	stress/fyk	stress/fck		stress/fck	spacing	width	min	provd	
	(kNm)			(kNm)				(mm)	
L end top	105.4	0.717	0.370	89.5	0.314	225.8	0.21	194	647
Midspan	78.1	0.598	0.083	66.3	0.071	262.4	0.20	62	615
R end top	126.1	0.791	0.407	106.9	0.345	222.4	0.22	333	709

Beam: 27

Location	Characteristic loads G+Q			Quasi-permanent loads G+ψ2Q				Steel for	
	Moment	steel	concrete	Moment	concrete	Crack		cracking	
	stress/fyk	stress/fck		stress/fck	spacing	width	min	provd	
	(kNm)			(kNm)				(mm)	
L end top	129.2	0.722	0.402	109.1	0.340	220.4	0.20	333	709
Midspan	77.8	0.596	0.083	66.0	0.070	262.4	0.20	62	615
R end top	99.8	0.621	0.340	84.7	0.289	234.8	0.19	215	615

JOINT GEOMETRY - SHEAR FORCES - VERIFICATION IN SHEAR

Joint	Max Φ	J width	J hor. shear	J hor. shear	J hor. steel	J ver. steel
		bj	Vjh	strength	area Ash	area Asv
	(mm)	(m)	(kN)	(kN)	(mm2)	(mm2)
1	16	0.40	0.	569.	0.	0.
2	28	0.50	0.	1048.	0.	0.
3	16	0.40	0.	575.	0.	0.

* STOREY: 1 * BEAMS: 28 27

* Concrete: C25 - Long. Reinforcement: S500 - Stirrups: S500 - Cover: 35 (mm) *

GEOMETRY - BENDING MOMENTS MED - LONGITUDINAL REINFORCEMENT

Beam:	28	Length l:	6.60m	X-section	T	Depth h:	0.50m	Width bw:	0.25m
Top flange thickness (m): 0.18 (L end) 0.18 (centre) 0.18 (R end)									
Location	Effect.	max MED	Required	Beam bars	Provided	Flexural			
	fl width		steel area	Contin	Addit	steel area	capacity		

	(m)	(kNm)	(mm ²)	(mm ²)	(kNm)
L end top	0.25	132.8	751.	2Φ14 1Φ14	754. 133.3
L end bot.	0.67	-22.6	375.	2Φ14 --	462. 87.9
midspan	2.63	103.7	537.	2Φ14 2Φ14	616. 118.8
R end top	0.25	174.4	1023.	2Φ14 2Φ14	1038. 183.4
R end bot.	1.09	-54.0	511.	2Φ14 --	616. 117.6

|Note: Top reinforcements include 250mm²/m of EC8s eff. slab width in tension |

|Note:1. Addit. bot. midspan bars extended: 1Φ14 to L end - 2Φ14 to R end |

| 2. Addit. bot. midspan bars extended to Left end of beam 2: 2Φ14 |

|Beam: 27|Length l: 6.60m|X-section T | Depth h: 0.50m| Width bw: 0.25m |

|Top flange thickness (m): 0.18 (L end) 0.18 (centre) 0.18 (R end)|

Location	Effect.	max MEd	Required	Beam bars	Provided	Flexural
	fl width		steel area	Contin Addit	steel area	capacity

	(m)	(kNm)	(mm ²)	(mm ²)	(kNm)
L end top	0.25	181.3	1071.	2Φ14 2Φ14	1038. 183.4
L end bot.	1.09	-60.3	535.	2Φ14 --	616. 117.6
midspan	2.63	103.8	537.	2Φ14 2Φ14	616. 118.8
R end top	0.25	126.5	712.	2Φ14 1Φ12	713. 126.8
R end bot.	0.67	-17.8	356.	2Φ14 --	462. 87.9

|Note: Top reinforcements include 250mm²/m of EC8s eff. slab width in tension |

|Note:1. Addit. bot. midspan bars extended: 1Φ14 to Right end. |

| 2. Addit. bot. midspan bars of beam 2 ext. to L end of beam 1: 2Φ14|

SLS CHECKS: STRESS LIMITS, CRACK WIDTH CONTROL FOR Wmax=0.3mm & min STEEL AREA

|Beam: 28 |

Location	Characteristic loads G+Q	Quasi-permanent loads G+ψ2Q	Steel for
	Moment steel	concrete	Moment concrete
	stress/fyk	stress/fck	stress/fck
			spacing
			width
			min provd

	(kNm)	(kNm)	(mm)	(mm ²)
L end top	91.5	0.816	0.351	77.7 0.298 267.7 0.28 215 461
Midspan	80.7	0.618	0.086	68.5 0.073 262.4 0.21 62 615
R end top	134.7	0.951	0.451	114.2 0.382 227.2 0.27 302 615

|Beam: 27 |

Location	Characteristic loads G+Q			Quasi-permanent loads G+ψ2Q				Steel for	
	Moment	steel stress/fyk	concrete stress/fck	Moment	concrete stress/fck	Crack spacing	width	cracking	
	(kNm)			(kNm)		(mm)		(mm2)	
L end top	141.1	0.874	0.453	119.7	0.385	224.9	0.25	302	615
Midspan	80.8	0.619	0.086	68.5	0.073	262.4	0.21	62	615
R end top	85.0	0.684	0.315	72.1	0.267	269.0	0.23	203	420

JOINT GEOMETRY - SHEAR FORCES - VERIFICATION IN SHEAR

Joint	Max Φ	J width	J hor. shear	J hor. shear	J hor. steel	J ver. steel
		bj	Vjh	strength	area Ash	area Asv
	(mm)	(m)	(kN)	(kN)	(mm2)	(mm2)
1	16	0.40	0.	499.	0.	0.
2	30	0.50	0.	570.	0.	0.
3	16	0.40	0.	508.	0.	0.

* STOREY: 0 * BEAMS: 28 27 26

* Concrete: C25 - Long. Reinforcement: S500 - Stirrups: S500 - Cover: 35 (mm) *

GEOMETRY - BENDING MOMENTS MED - LONGITUDINAL REINFORCEMENT

Beam	Length l	X-section	Depth h	Width bw		
28	6.60m	T	0.50m	0.25m		
Top flange thickness (m): 0.18 (L end) 0.18 (centre) 0.18 (R end)						
Location	Effect. fl width	max MEd	Required steel area	Beam bars	Provided steel area	Flexural capacity
	(m)	(kNm)	(mm2)	Contin	Addit	(kNm)
L end top	0.25	179.6	1058.	3Φ10	3Φ18	999. 174.0
L end bot.	0.67	-106.8	149.	2Φ10	--	157. 30.3
midspan	2.63	86.8	449.	2Φ10	2Φ14	465. 89.9
R end top	0.25	145.0	829.	3Φ10	3Φ16	839. 146.6
R end bot.	1.09	-78.8	149.	2Φ10	--	157. 30.4

Beam	Length l	X-section	Depth h	Width bw
27	6.60m	T	0.50m	0.25m

Top flange thickness (m): 0.18 (L end) 0.18 (centre) 0.18 (R end)							
Location	Effect.	max MEd	Required	Beam bars	Provided	Flexural	
fl width			steel area	Contin Addit	steel area	capacity	
--- (m) ---	--- (kNm) ---	--- (mm2) ---	--- (mm2) ---	--- (kNm) ---	--- (kNm) ---	--- (kNm) ---	--- (kNm) ---
L end top	0.25	150.2	862.	3Φ10 3Φ16	839.	146.6	
L end bot.	1.09	-82.3	149.	2Φ10 --	157.	30.4	
midspan	2.63	83.5	432.	2Φ10 2Φ14	465.	89.9	
R end top	0.25	181.0	1068.	3Φ10 7Φ12	1027.	178.4	
R end bot.	0.67	-106.9	149.	2Φ10 --	157.	30.3	

|Beam: 26|Length l: 6.70m|X-section T | Depth h: 0.50m| Width bw: 0.25m |

Top flange thickness (m): 0.18 (L end) 0.18 (centre) 0.18 (R end)							
Location	Effect.	max MEd	Required	Beam bars	Provided	Flexural	
fl width			steel area	Contin Addit	steel area	capacity	
--- (m) ---	--- (kNm) ---	--- (mm2) ---	--- (mm2) ---	--- (kNm) ---	--- (kNm) ---	--- (kNm) ---	--- (kNm) ---
L end top	0.25	159.7	924.	3Φ10 6Φ12	914.	158.2	
L end bot.	1.09	-97.0	149.	2Φ10 --	157.	30.4	
midspan	2.63	88.2	456.	2Φ10 2Φ14	465.	89.9	
R end top	0.25	162.1	940.	3Φ10 6Φ12	914.	158.2	
R end bot.	0.67	-100.9	149.	2Φ10 --	157.	30.3	

SLS CHECKS: STRESS LIMITS, CRACK WIDTH CONTROL FOR Wmax=0.3mm & min STEEL AREA

|Beam: 28 |

Location	Characteristic loads G+Q	Quasi-permanent loads G+ψ2Q	Steel for	
Moment steel	concrete	Moment concrete	Crack	cracking
stress/fyk	stress/fck	stress/fck	spacing width	min provd
--- (kNm) ---	--- (kNm) ---	--- (kNm) ---	--- (mm) ---	--- (mm2) ---
L end top	139.7	0.670	0.503	118.6 0.427 202.0 0.17 531 999
Midspan	67.5	0.680	0.083	57.3 0.070 277.9 0.24 62 464
R end top	112.9	0.627	0.424	95.7 0.359 201.5 0.16 716 838

|Beam: 27 |

Location	Characteristic loads G+Q	Quasi-permanent loads G+ψ2Q	Steel for	
Moment steel	concrete	Moment concrete	Crack	cracking

	stress/fyk	stress/fck	stress/fyk	stress/fck	spacing	width	min	provd
	(kNm)		(kNm)		(mm)		(mm ²)	
L end top	116.9	0.588	0.426	99.1	0.362	200.1	0.15	716 838
Midspan	65.0	0.654	0.079	55.1	0.067	277.9	0.23	62 464
R end top	140.9	0.607	0.492	119.5	0.417	186.2	0.14	462 1027

|Beam: 26

Location	Characteristic loads G+Q	Quasi-permanent loads G+ψ2Q	Steel for					
	Moment steel	concrete	Moment concrete					
	stress/fyk	stress/fck	stress/fck					
	(kNm)		(kNm)					
			spacing					
			width					
			min					
			provd					
			(mm ²)					
L end top	124.3	0.586	0.445	105.4	0.377	187.3	0.14	659 914
Midspan	68.6	0.691	0.084	58.2	0.071	277.9	0.24	62 464
R end top	126.2	0.595	0.452	107.1	0.383	191.6	0.15	461 914

* STOREY: -1 * BEAMS: 28 27 26

* Concrete: C25 - Long. Reinforcement: S500 - Stirrups: S500 - Cover: 35 (mm) *

GEOMETRY - BENDING MOMENTS MED - LONGITUDINAL REINFORCEMENT

Beam:	28	Length l:	6.60m	X-section	T	Depth h:	0.50m	Width bw:	0.25m
		Top flange thickness (m):	0.18 (L end)	0.18 (centre)	0.18 (R end)				
Location	Effect.	max MEd	Required	Beam bars	Provided	Flexural			
	fl width	(kNm)	steel area	Contin	Addit	steel area			
	(m)	(kNm)	(mm ²)	(mm ²)	(kNm)	capacity			
L end top	0.25	163.1	947.	3Φ10	6Φ12	914.	158.2		
L end bot.	0.67	-104.0	149.	2Φ10	--	157.	30.3		
midspan	2.63	87.9	455.	2Φ10	2Φ14	465.	89.9		
R end top	0.25	159.2	921.	3Φ10	2Φ20	864.	150.5		
R end bot.	1.09	-102.6	149.	2Φ10	--	157.	30.4		

|Beam: 27|Length l: 6.60m|X-section T | Depth h: 0.50m| Width bw: 0.25m |

|Top flange thickness (m): 0.18 (L end) 0.18 (centre) 0.18 (R end)|

Location	Effect.	max MEd	Required	Beam bars	Provided	Flexural
fl width			steel area	Contin Addit	steel area	capacity
--- (m) ---	--- (kNm) ---	--- (mm2) ---	--- (mm2) ---	--- (kNm) ---		
L end top	0.25	159.5	923.	3Φ10 2Φ20	864.	150.5
L end bot.	1.09	-104.0	149.	2Φ10 --	157.	30.4
midspan	2.63	83.4	431.	2Φ10 2Φ14	465.	89.9
R end top	0.25	171.9	1006.	3Φ10 7Φ12	1027.	178.4
R end bot.	0.67	-111.9	149.	2Φ10 --	157.	30.3

|Beam: 26|Length l: 6.70m|X-section T | Depth h: 0.50m| Width bw: 0.25m |

|Top flange thickness (m): 0.18 (L end) 0.18 (centre) 0.18 (R end)|

Location	Effect.	max MEd	Required	Beam bars	Provided	Flexural
fl width			steel area	Contin Addit	steel area	capacity
--- (m) ---	--- (kNm) ---	--- (mm2) ---	--- (mm2) ---	--- (kNm) ---		
L end top	0.25	166.7	971.	3Φ10 6Φ12	914.	158.2
L end bot.	1.09	-105.9	149.	2Φ10 --	157.	30.4
midspan	2.63	87.0	450.	2Φ10 2Φ14	465.	89.9
R end top	0.25	157.6	910.	3Φ10 2Φ20	864.	150.5
R end bot.	0.67	-98.8	149.	2Φ10 --	157.	30.3

SLS CHECKS: STRESS LIMITS, CRACK WIDTH CONTROL FOR Wmax=0.3mm & min STEEL AREA

|Beam: 28 |

Location	Characteristic loads G+Q	Quasi-permanent loads G+ψ2Q	Steel for
Moment steel concrete	Moment concrete	Crack	cracking
stress/fyk stress/fck	stress/fck	spacing	width min provd
--- (kNm) ---	--- (kNm) ---	--- (mm) ---	--- (mm2) ---
L end top 126.9 0.656 0.467	107.7 0.396	192.7 0.16	461 914
Midspan 68.4 0.689 0.084	58.0 0.071	277.9 0.24	62 464
R end top 123.9 0.672 0.462	105.1 0.392	207.8 0.18	775 863

|Beam: 27 |

Location	Characteristic loads G+Q	Quasi-permanent loads G+ψ2Q	Steel for
Moment steel concrete	Moment concrete	Crack	cracking
stress/fyk stress/fck	stress/fck	spacing	width min provd

	-- (kNm) -----			-- (kNm) -----			-- (mm) -----		-- (mm2) --	
L end top	124.1	0.611	0.450	105.3	0.382	206.2	0.16	775	863	
Midspan	64.9	0.653	0.079	55.0	0.067	277.9	0.23	62	464	
R end top	133.8	0.576	0.467	113.5	0.396	186.2	0.14	462	1027	
+-----+										
Beam: 26										
+-----+										
Location	Characteristic loads G+Q			Quasi-permanent loads G+ψ2Q			Steel for			
	Moment steel		concrete	Moment concrete		Crack	cracking			
	stress/fyk		stress/fck	stress/fck		spacing	width	min provd		
	-- (kNm) -----			-- (kNm) -----			-- (mm) -----		-- (mm2) --	
L end top	129.7	0.611	0.464	110.0	0.394	187.3	0.15	659	914	
Midspan	67.7	0.681	0.083	57.4	0.070	277.9	0.24	62	464	
R end top	122.6	0.603	0.444	104.0	0.377	212.7	0.16	543	863	
+-----+										
+-----+										

3A 1.6 FRAME 3

* STOREY: 6 * BEAMS: 31 30										

* Concrete: C25 - Long. Reinforcement: S500 - Stirrups: S500 - Cover: 35 (mm) *										

GEOMETRY - BENDING MOMENTS MED - LONGITUDINAL REINFORCEMENT										
+-----+										
Beam: 31	Length l: 6.60m			X-section T	Depth h: 0.50m		Width bw: 0.25m			
+-----+										
Top flange thickness (m): 0.18 (L end) 0.18 (centre) 0.18 (R end)										
+-----+										
Location	Effect.	max MEd	Required	Beam bars	Provided	Flexural				
	fl width	steel area		Contin Addit	steel area	capacity				
	(m)	(kNm)	(mm2)	(mm2)	(kNm)					
L end top	0.25	90.9	579.	2Φ14	--	600.	108.3			
L end bot.	0.67	13.7	290.	2Φ14	--	308.	59.0			
midspan	2.63	72.8	376.	2Φ14	1Φ14	462.	89.3			
R end top	0.25	141.3	805.	2Φ14	--	843.	147.3			
R end bot.	1.09	-20.1	402.	2Φ14	--	462.	88.6			
Note: Top reinforcements include 250mm2/m of EC8s eff. slab width in tension										
Note:1. Addit. bot. midspan bars extended: 1Φ14 to Right end.										

JOINT GEOMETRY - SHEAR FORCES - VERIFICATION IN SHEAR

Joint	Max Φ	J width	J hor. shear	J hor. shear	J hor. steel	J ver. steel
		b_j	V_{jh}	strength	area A_{sh}	area A_{sv}
	(mm)	(m)	(kN)	(kN)	(mm ²)	(mm ²)
1	14	0.40	0.	807.	0.	0.
2	22	0.50	0.	2067.	0.	0.
3	14	0.40	0.	807.	0.	0.

* STOREY: 5 * BEAMS: 31 30

* Concrete: C25 - Long. Reinforcement: S500 - Stirrups: S500 - Cover: 35 (mm) *

GEOMETRY - BENDING MOMENTS MED - LONGITUDINAL REINFORCEMENT

Beam:	31	Length l:	6.60m	X-section	T	Depth h:	0.50m	Width bw:	0.25m

Top flange thickness (m): 0.18 (L end) 0.18 (centre) 0.18 (R end)									

Location	Effect.	max MEd	Required	Beam bars	Provided	Flexural			
	fl width		steel area	Contin	Addit	steel area capacity			
	(m)	(kNm)	(mm ²)			(mm ²)	(kNm)		
L end top	0.25	145.6	833.	2 Φ 14	2 Φ 12	827.	144.7		
L end bot.	0.67	27.0	416.	2 Φ 14	--	462.	87.9		
midspan	2.63	65.1	336.	2 Φ 14	1 Φ 14	462.	89.3		
R end top	0.25	163.9	952.	2 Φ 14	1 Φ 16	931.	160.8		
R end bot.	1.09	23.5	476.	2 Φ 14	--	462.	88.6		

|Note: Top reinforcements include 250mm²/m of EC8s eff. slab width in tension |

|Note:1. Addit. bot. midspan bars extended: 1 Φ 14 to L end - 1 Φ 14 to R end |

| 2. Addit. bot. midspan bars extended to Left end of beam 2: 1 Φ 14 |

Beam:	30	Length l:	6.60m	X-section	T	Depth h:	0.50m	Width bw:	0.25m

Top flange thickness (m): 0.18 (L end) 0.18 (centre) 0.18 (R end)									

Location	Effect.	max MEd	Required	Beam bars	Provided	Flexural			
	fl width		steel area	Contin	Addit	steel area capacity			
	(m)	(kNm)	(mm ²)			(mm ²)	(kNm)		
L end top	0.25	167.3	975.	2 Φ 14	1 Φ 16	931.	160.8		

L end bot.	1.09	18.5	487.	2Φ14	--	462.	88.6
midspan	2.63	64.8	335.	2Φ14	1Φ14	462.	89.3
R end top	0.25	141.1	803.	2Φ14	2Φ12	827.	144.7
R end bot.	0.67	30.2	402.	2Φ14	--	462.	87.9

|Note: Top reinforcements include 250mm²/m of EC8s eff. slab width in tension |

|Note:1. Addit. bot. midspan bars extended: 1Φ14 to Right end. |

| 2. Addit. bot. midspan bars of beam 2 ext. to L end of beam 1: 1Φ14 |

SLS CHECKS: STRESS LIMITS, CRACK WIDTH CONTROL FOR W_{max}=0.3mm & min STEEL AREA

Beam: 31										
Location	Characteristic loads G+Q	Quasi-permanent loads G+ψ ₂ Q	Steel for							
	Moment steel	concrete	Moment concrete	Crack						cracking
	stress/fyk	stress/fck	stress/fck	spacing			width			min provd
	-- (kNm) --		-- (kNm) --		-- (mm) --		-- (mm ²) --			
L end top	69.8	0.555	0.258	59.3	0.219	244.6	0.17	197	534	
Midspan	50.6	0.513	0.062	43.0	0.053	296.6	0.19	62	461	
R end top	82.9	0.685	0.309	70.2	0.262	245.5	0.21	323	508	

Beam: 30										
Location	Characteristic loads G+Q	Quasi-permanent loads G+ψ ₂ Q	Steel for							
	Moment steel	concrete	Moment concrete	Crack						cracking
	stress/fyk	stress/fck	stress/fck	spacing			width			min provd
	-- (kNm) --		-- (kNm) --		-- (mm) --		-- (mm ²) --			
L end top	87.8	0.623	0.312	74.4	0.265	242.4	0.19	323	508	
Midspan	50.4	0.511	0.062	42.8	0.052	296.6	0.19	62	461	
R end top	65.3	0.449	0.230	55.5	0.195	241.6	0.14	197	534	

JOINT GEOMETRY - SHEAR FORCES - VERIFICATION IN SHEAR

Joint	Max Φ	J width	J hor. shear	J hor. shear	J hor. steel	J ver. steel					
		b _j	V _{jh}	strength	area A _{sh}	area A _{sv}					
		(mm)	(m)	(kN)	(kN)	(mm ²)	(mm ²)				
1	14	0.40	0.	765.	0.	0.					
2	22	0.50	0.	1923.	0.	0.					
3	14	0.40	0.	765.	0.	0.					

 * STOREY: 4 * BEAMS: 31 30

* Concrete: C25 - Long. Reinforcement: S500 - Stirrups: S500 - Cover: 35 (mm) *

GEOMETRY - BENDING MOMENTS MED - LONGITUDINAL REINFORCEMENT

+-----+							
Beam: 31 Length l: 6.60m X-section T Depth h: 0.50m Width bw: 0.25m							
-----+							
Top flange thickness (m): 0.18 (L end) 0.18 (centre) 0.18 (R end)							
-----+							
Location	Effect.	max MEd	Required	Beam bars	Provided	Flexural	
fl width			steel area	Contin	Addit	steel area	capacity
-----	---	---	---	-----	---	---	---
(m)	(kNm)	(kNm)	(mm ²)	(mm ²)	(mm ²)	(kNm)	
L end top	0.25	139.5	793.	2Φ14	1Φ12	801.	140.8
L end bot.	0.67	28.9	397.	2Φ14	--	462.	87.9
midspan	2.63	66.1	341.	2Φ14	1Φ14	462.	89.3
R end top	0.25	163.6	950.	2Φ14	1Φ16	931.	160.8
R end bot.	1.09	19.6	475.	2Φ14	--	462.	88.6
Note: Top reinforcements include 250mm ² /m of EC8s eff. slab width in tension							
Note:1. Addit. bot. midspan bars extended: 1Φ14 to L end - 1Φ14 to R end							
2. Addit. bot. midspan bars extended to Left end of beam 2: 1Φ14							

+-----+							
Beam: 30 Length l: 6.60m X-section T Depth h: 0.50m Width bw: 0.25m							
-----+							
Top flange thickness (m): 0.18 (L end) 0.18 (centre) 0.18 (R end)							
-----+							
Location	Effect.	max MEd	Required	Beam bars	Provided	Flexural	
fl width			steel area	Contin	Addit	steel area	capacity
-----	---	---	---	-----	---	---	---
(m)	(kNm)	(kNm)	(mm ²)	(mm ²)	(mm ²)	(kNm)	
L end top	0.25	166.9	972.	2Φ14	1Φ16	931.	160.8
L end bot.	1.09	14.7	486.	2Φ14	--	462.	88.6
midspan	2.63	65.8	340.	2Φ14	1Φ14	462.	89.3
R end top	0.25	137.0	778.	2Φ14	1Φ14	754.	133.3
R end bot.	0.67	30.1	389.	2Φ14	--	462.	87.9
Note: Top reinforcements include 250mm ² /m of EC8s eff. slab width in tension							
Note:1. Addit. bot. midspan bars extended: 1Φ14 to Right end.							
2. Addit. bot. midspan bars of beam 2 ext. to L end of beam 1: 1Φ14							

+-----+
 +-----+
 SLS CHECKS: STRESS LIMITS, CRACK WIDTH CONTROL FOR Wmax=0.3mm & min STEEL AREA

Beam: 31									
Location	Characteristic loads G+Q			Quasi-permanent loads G+ψ2Q				Steel for	
	Moment	steel	concrete	Moment	concrete	Crack	spacing	width	min provd
	stress/fyk	stress/fck		stress/fck					
	(kNm)			(kNm)		(mm)			(mm2)
L end top	65.2	0.539	0.244	55.3	0.206	274.1	0.19	259	508
Midspan	51.4	0.521	0.063	43.6	0.053	296.6	0.20	62	461
R end top	85.0	0.702	0.317	72.0	0.269	245.5	0.22	323	508

Beam: 30									
Location	Characteristic loads G+Q			Quasi-permanent loads G+ψ2Q				Steel for	
	Moment	steel	concrete	Moment	concrete	Crack	spacing	width	min provd
	stress/fyk	stress/fck		stress/fck					
	(kNm)			(kNm)		(mm)			(mm2)
L end top	89.8	0.638	0.319	76.1	0.271	242.4	0.20	323	508
Midspan	51.2	0.519	0.063	43.5	0.053	296.6	0.20	62	461
R end top	62.8	0.476	0.228	53.5	0.194	263.8	0.16	215	461

JOINT GEOMETRY - SHEAR FORCES - VERIFICATION IN SHEAR

Joint	Max Φ	J width	J hor. shear	J hor. shear	J hor. steel	J ver. steel
		bj	Vjh	strength	area Ash	area Asv
	(mm)	(m)	(kN)	(kN)	(mm2)	(mm2)
1	14	0.40	0.	720.	0.	0.
2	24	0.50	0.	1765.	0.	0.
3	14	0.40	0.	721.	0.	0.

* STOREY: 3 * BEAMS: 31 30

* Concrete: C25 - Long. Reinforcement: S500 - Stirrups: S500 - Cover: 35 (mm) *

GEOMETRY - BENDING MOMENTS MED - LONGITUDINAL REINFORCEMENT

Beam:	31	Length l:	6.60m	X-section	T	Depth h:	0.50m	Width bw:	0.25m
		Top flange thickness (m): 0.18 (L end) 0.18 (centre) 0.18 (R end)							

Location	Effect.	max MEd	Required	Beam bars	Provided	Flexural
fl width			steel area	Contin Addit	steel area	capacity
(m)	(kNm)	(mm ²)	(mm ²)		(mm ²)	(kNm)
L end top	0.25	136.7	775.	2Φ14 1Φ14	754.	133.3
L end bot.	0.67	27.1	388.	2Φ14 --	462.	87.9
midspan	2.63	65.9	340.	2Φ14 1Φ14	462.	89.3
R end top	0.25	161.5	936.	2Φ14 1Φ16	931.	160.8
R end bot.	1.09	16.8	468.	2Φ14 --	462.	88.6

Note: Top reinforcements include 250mm²/m of EC8s eff. slab width in tension
Note:1. Addit. bot. midspan bars extended: 1Φ14 to L end - 1Φ14 to R end
2. Addit. bot. midspan bars extended to Left end of beam 2: 1Φ14

Beam: 30 | Length l: 6.60m | X-section T | Depth h: 0.50m | Width bw: 0.25m

Top flange thickness (m): 0.18 (L end) 0.18 (centre) 0.18 (R end)

Location	Effect.	max MEd	Required	Beam bars	Provided	Flexural
fl width			steel area	Contin Addit	steel area	capacity
(m)	(kNm)	(mm ²)	(mm ²)		(mm ²)	(kNm)
L end top	0.25	164.9	959.	2Φ14 1Φ16	931.	160.8
L end bot.	1.09	11.7	479.	2Φ14 --	462.	88.6
midspan	2.63	65.6	339.	2Φ14 1Φ14	462.	89.3
R end top	0.25	134.7	763.	2Φ14 1Φ14	754.	133.3
R end bot.	0.67	27.8	382.	2Φ14 --	462.	87.9

Note: Top reinforcements include 250mm²/m of EC8s eff. slab width in tension
Note:1. Addit. bot. midspan bars extended: 1Φ14 to Right end.
2. Addit. bot. midspan bars of beam 2 ext. to L end of beam 1: 1Φ14

SLS CHECKS: STRESS LIMITS, CRACK WIDTH CONTROL FOR Wmax=0.3mm & min STEEL AREA

Beam: 31

Location	Characteristic loads G+Q	Quasi-permanent loads G+ψ2Q	Steel for						
	Moment steel	concrete	Moment concrete						
	stress/fyk	stress/fck	stress/fck						
(kNm)			spacing						
			width						
			min provd						
			(mm)						
			(mm ²)						
L end top	64.7	0.577	0.248	54.8	0.210	267.7	0.20	215	461
Midspan	51.2	0.519	0.063	43.5	0.053	296.6	0.20	62	461
R end top	85.4	0.705	0.319	72.3	0.270	245.5	0.22	323	508

Location	Characteristic loads G+Q	Quasi-permanent loads G+ψ2Q	Steel for
	Moment steel	concrete	cracking
	stress/fyk	stress/fck	spacing width
	(kNm)	(kNm)	(mm)
L end top	90.4	0.642	0.321
Midspan	51.1	0.518	0.063
R end top	62.8	0.476	0.228

JOINT GEOMETRY - SHEAR FORCES - VERIFICATION IN SHEAR

Joint	Max Φ	J width	J hor. shear	J hor. shear	J hor. steel	J ver. steel
		bj	Vjh	strength	area Ash	area Asv
	(mm)	(m)	(kN)	(kN)	(mm2)	(mm2)
1	14	0.40	0.	674.	0.	0.
2	24	0.50	0.	1592.	0.	0.
3	14	0.40	0.	674.	0.	0.

* STOREY: 2 * BEAMS: 31 30

* Concrete: C25 - Long. Reinforcement: S500 - Stirrups: S500 - Cover: 35 (mm) *

GEOMETRY - BENDING MOMENTS MED - LONGITUDINAL REINFORCEMENT

Location	Effect.	max MED	Required	Beam bars	Provided	Flexural
	fl width		steel area	Contin Addit	steel area	capacity
	(m)	(kNm)	(mm2)		(mm2)	(kNm)
L end top	0.25	129.8	732.	2Φ14 1Φ12	713.	126.8
L end bot.	0.67	16.9	366.	2Φ14 --	462.	87.9
midspan	2.63	65.5	338.	2Φ14 1Φ14	462.	89.3
R end top	0.25	152.4	876.	2Φ14 1Φ14	884.	153.6
R end bot.	1.09	7.4	438.	2Φ14 --	462.	88.6

[Note: Top reinforcements include 250mm2/m of EC8s eff. slab width in tension]

|Note:1. Addit. bot. midspan bars extended: 1Φ14 to L end - 1Φ14 to R end |
 | 2. Addit. bot. midspan bars extended to Left end of beam 2: 1Φ14 |
 +-----+
 +-----+
 |Beam: 30|Length l: 6.60m|X-section T | Depth h: 0.50m| Width bw: 0.25m |
 |-----+-----+
 | |Top flange thickness (m): 0.18 (L end) 0.18 (centre) 0.18 (R end)|
 |-----+-----+
 | Location |Effect. | max MEd | Required | Beam bars | Provided |Flexural|
 | |fl width| |steel area |Contin Addit |steel area|capacity|
 |-----+--- (m) ---+--- (kNm) ---+--- (mm2) ---+-----+--- (mm2) ---+--- (kNm) ---+
L end top	0.25	156.1	900.	2Φ14 1Φ14	884.	153.6
L end bot.	1.09	2.0	450.	2Φ14 --	462.	88.6
midspan	2.63	65.0	336.	2Φ14 1Φ14	462.	89.3
R end top	0.25	127.7	719.	2Φ14 1Φ12	713.	126.8
R end bot.	0.67	17.7	360.	2Φ14 --	462.	87.9
Note: Top reinforcements include 250mm²/m of EC8s eff. slab width in tension						
Note:1. Addit. bot. midspan bars extended: 1Φ14 to Right end.						
2. Addit. bot. midspan bars of beam 2 ext. to L end of beam 1: 1Φ14						

+-----+
 +-----+
 SLS CHECKS: STRESS LIMITS, CRACK WIDTH CONTROL FOR W_{max}=0.3mm & min STEEL AREA
 +-----+
 +-----+
 |Beam: 31 |
 +-----+
 +-----+
Location	Characteristic loads G+Q	Quasi-permanent loads G+ψ2Q	Steel for
	Moment steel concrete	Moment concrete Crack	cracking
	stress/fyk stress/fck	stress/fck spacing width	min provd
-----+--- (kNm) ---+--- (kNm) ---+--- (mm) ---+--- (mm2) ---+			
L end top	66.5 0.637 0.261	56.5 0.222 273.2 0.22	203 420
Midspan	51.0 0.517 0.062	43.3 0.053 296.6 0.20	62 461
R end top	85.5 0.763 0.328	72.5 0.278 248.7 0.24	302 461

+-----+
 +-----+
 |Beam: 30 |
 +-----+
 +-----+
Location	Characteristic loads G+Q	Quasi-permanent loads G+ψ2Q	Steel for
	Moment steel concrete	Moment concrete Crack	cracking
	stress/fyk stress/fck	stress/fck spacing width	min provd
-----+--- (kNm) ---+--- (kNm) ---+--- (mm) ---+--- (mm2) ---+			
L end top	90.8 0.688 0.330	77.0 0.280 245.4 0.21	302 461
Midspan	50.6 0.513 0.062	42.9 0.053 296.6 0.19	62 461
R end top	64.4 0.518 0.238	55.0 0.204 269.0 0.18	203 420

```

+-----+-----+-----+-----+-----+-----+-----+-----+
+-----+-----+-----+-----+-----+-----+-----+-----+

```

JOINT GEOMETRY - SHEAR FORCES - VERIFICATION IN SHEAR

```

+-----+-----+-----+-----+-----+-----+-----+-----+
|Joint|Max Φ| J width | J hor. shear| J hor. shear| J hor. steel| J ver. steel|
|      |      | bj      | Vjh         | strength    | area Ash   | area Asv   |
+-----+- (mm)+--- (m) ---+---- (kN) ----+---- (kN) ----+---- (mm2) ----+---- (mm2) ----+
|  1  |  14 |  0.40  |      0.     |      624.   |      0.    |      0.    |
|  2  |  26 |  0.50  |      0.     |     1399.   |      0.    |      0.    |
|  3  |  14 |  0.40  |      0.     |      625.   |      0.    |      0.    |
+-----+-----+-----+-----+-----+-----+-----+-----+

```

```

*-----*
* STOREY:  1 * BEAMS:  31  30
*-----*
* Concrete: C25 - Long. Reinforcement: S500 - Stirrups: S500 - Cover: 35 (mm) *
*-----*

```

GEOMETRY - BENDING MOMENTS MED - LONGITUDINAL REINFORCEMENT

```

+-----+-----+-----+-----+-----+-----+-----+-----+
|Beam:   31|Length l: 6.60m|X-section T | Depth h: 0.50m| Width bw: 0.25m |
|-----+-----+-----+-----+-----+-----+-----+-----+
|           |Top flange thickness (m): 0.18 (L end) 0.18 (centre) 0.18 (R end)|
|-----+-----+-----+-----+-----+-----+-----+-----+
| Location |Effect. | max MEd | Required | Beam bars | Provided |Flexural|
|           |fl width|          | steel area | Contin Addit | steel area|capacity|
|-----+-----+-----+-----+-----+-----+-----+-----+
|L end top | 0.25  |  101.4  |   579.   | 2Φ14    -- |   600.   | 108.3  |
|L end bot. | 0.67  |    2.0  |   290.   | 2Φ14    -- |   308.   |  59.0  |
|midspan   | 2.63  |   67.4  |   348.   | 2Φ14    1Φ14|   462.   |  89.3  |
|R end top  | 0.25  |  133.4  |   755.   | 2Φ14    1Φ12|   884.   | 153.6  |
|R end bot. | 1.09  |  -20.1  |   377.   | 2Φ14    -- |   462.   |  88.6  |
|Note: Top reinforcements include 250mm2/m of EC8s eff. slab width in tension |
|Note:1. Addit. bot. midspan bars extended:  1Φ14 to Right end.                |
|     2. Addit. bot. midspan bars extended to Left end of beam                 2: 1Φ14 |
+-----+-----+-----+-----+-----+-----+-----+-----+

```

```

+-----+-----+-----+-----+-----+-----+-----+-----+
|Beam:   30|Length l: 6.60m|X-section T | Depth h: 0.50m| Width bw: 0.25m |
|-----+-----+-----+-----+-----+-----+-----+-----+
|           |Top flange thickness (m): 0.18 (L end) 0.18 (centre) 0.18 (R end)|
|-----+-----+-----+-----+-----+-----+-----+-----+
| Location |Effect. | max MEd | Required | Beam bars | Provided |Flexural|
|           |fl width|          | steel area | Contin Addit | steel area|capacity|
+-----+-----+-----+-----+-----+-----+-----+-----+

```

	(m)	(kNm)	(mm ²)	(mm ²)	(kNm)
L end top	0.25	137.5	780.	2Φ14 1Φ12	884. 153.6
L end bot.	1.09	-25.7	390.	2Φ14 --	462. 88.6
midspan	2.63	68.3	353.	2Φ14 1Φ14	462. 89.3
R end top	0.25	94.8	579.	2Φ14 --	600. 108.3
R end bot.	0.67	7.4	290.	2Φ14 --	308. 59.0

|Note: Top reinforcements include 250mm²/m of EC8s eff. slab width in tension |
|Note:1. Addit. bot. midspan bars of beam 2 ext. to L end of beam 1: 1Φ14|

SLS CHECKS: STRESS LIMITS, CRACK WIDTH CONTROL FOR Wmax=0.3mm & min STEEL AREA

Beam: 31									
Location	Characteristic loads G+Q			Quasi-permanent loads G+ψ2Q			Steel for		
	Moment	steel	concrete	Moment	concrete	Crack	cracking		
	stress/fyk	stress/fck		stress/fck	spacing	width	min provd		
	(kNm)			(kNm)	(mm)		(mm ²)--		
L end top	58.5	0.710	0.266	49.7	0.226	319.4	0.29	215	307
Midspan	52.5	0.532	0.064	44.5	0.055	296.6	0.20	62	461
R end top	90.6	0.808	0.347	76.7	0.294	253.8	0.26	322	461

Beam: 30									
Location	Characteristic loads G+Q			Quasi-permanent loads G+ψ2Q			Steel for		
	Moment	steel	concrete	Moment	concrete	Crack	cracking		
	stress/fyk	stress/fck		stress/fck	spacing	width	min provd		
	(kNm)			(kNm)	(mm)		(mm ²)--		
L end top	96.2	0.729	0.349	81.6	0.296	250.4	0.23	322	461
Midspan	53.1	0.539	0.065	45.1	0.055	296.6	0.20	62	461
R end top	51.4	0.502	0.217	43.7	0.184	312.8	0.20	215	307

JOINT GEOMETRY - SHEAR FORCES - VERIFICATION IN SHEAR

Joint	Max Φ	J width	J hor. shear	J hor. shear	J hor. steel	J ver. steel
		bj	Vjh	strength	area Ash	area Asv
	(mm)	(m)	(kN)	(kN)	(mm ²)	(mm ²)
1	16	0.40	0.	573.	0.	0.
2	26	0.50	0.	1179.	0.	0.
3	16	0.40	0.	575.	0.	0.

* STOREY: 0 * BEAMS: 31 30 29

* Concrete: C25 - Long. Reinforcement: S500 - Stirrups: S500 - Cover: 35(mm) *

GEOMETRY - BENDING MOMENTS MED - LONGITUDINAL REINFORCEMENT

+-----+							
Beam: 31 Length l: 6.60m X-section T Depth h: 0.50m Width bw: 0.25m							
-----+							
Top flange thickness (m): 0.18 (L end) 0.18 (centre) 0.18 (R end)							
-----+							
Location	Effect.	max MEd	Required	Beam bars	Provided	Flexural	
fl width			steel area	Contin	Addit	steel area	capacity
-----	---	---	---	-----	---	---	---
(m)	(kNm)	(kNm)	(mm2)	(mm2)	(mm2)	(kNm)	
L end top	0.25	110.3	612.	2Φ10 3Φ14	619.	111.3	
L end bot.	0.67	-60.1	149.	2Φ10 --	157.	30.3	
midspan	2.63	59.1	305.	2Φ10 1Φ14	311.	60.2	
R end top	0.25	97.9	539.	2Φ10 3Φ12	723.	128.3	
R end bot.	1.09	-47.7	149.	2Φ10 --	157.	30.4	
+-----+							

+-----+							
Beam: 30 Length l: 6.60m X-section T Depth h: 0.50m Width bw: 0.25m							
-----+							
Top flange thickness (m): 0.18 (L end) 0.18 (centre) 0.18 (R end)							
-----+							
Location	Effect.	max MEd	Required	Beam bars	Provided	Flexural	
fl width			steel area	Contin	Addit	steel area	capacity
-----	---	---	---	-----	---	---	---
(m)	(kNm)	(kNm)	(mm2)	(mm2)	(mm2)	(kNm)	
L end top	0.25	96.4	530.	2Φ10 3Φ12	723.	128.3	
L end bot.	1.09	-47.6	149.	2Φ10 --	157.	30.4	
midspan	2.63	50.6	261.	2Φ10 1Φ14	311.	60.2	
R end top	0.25	128.8	726.	2Φ10 5Φ12	723.	128.3	
R end bot.	0.67	-72.9	149.	2Φ10 --	157.	30.3	
+-----+							

+-----+							
Beam: 29 Length l: 6.70m X-section T Depth h: 0.50m Width bw: 0.25m							
-----+							
Top flange thickness (m): 0.18 (L end) 0.18 (centre) 0.18 (R end)							
-----+							
Location	Effect.	max MEd	Required	Beam bars	Provided	Flexural	
fl width			steel area	Contin	Addit	steel area	capacity
-----	---	---	---	-----	---	---	---
(m)	(kNm)	(kNm)	(mm2)	(mm2)	(mm2)	(kNm)	
L end top	0.25	110.3	612.	2Φ10 3Φ14	619.	111.3	
L end bot.	0.67	-60.1	149.	2Φ10 --	157.	30.3	
midspan	2.63	59.1	305.	2Φ10 1Φ14	311.	60.2	
R end top	0.25	97.9	539.	2Φ10 3Φ12	723.	128.3	
R end bot.	1.09	-47.7	149.	2Φ10 --	157.	30.4	
+-----+							

	(m)	(kNm)	(mm ²)		(mm ²)	(kNm)
L end top	0.25	159.7	924.	3Φ10	6Φ12	914. 158.2
L end bot.	1.09	-99.1	149.	2Φ10	--	157. 30.4
midspan	2.63	93.8	485.	2Φ10	2Φ14	465. 89.9
R end top	0.25	150.8	866.	3Φ10	2Φ20	864. 150.5
R end bot.	0.67	-91.3	149.	2Φ10	--	157. 30.3

SLS CHECKS: STRESS LIMITS, CRACK WIDTH CONTROL FOR Wmax=0.3mm & min STEEL AREA

Beam: 31									
Location	Characteristic loads G+Q			Quasi-permanent loads G+ψ2Q			Steel for		
	Moment	steel	concrete	Moment	concrete	Crack	cracking		
	stress/fyk	stress/fck		stress/fck	spacing	width	min provd		
	(kNm)			(kNm)	(mm)	(mm ²)			
L end top	85.8	0.612	0.348	72.9	0.296	225.3	0.18	483	618
Midspan	46.0	0.684	0.069	39.0	0.058	321.8	0.28	62	311
R end top	76.2	0.479	0.297	64.6	0.252	200.1	0.12	661	722

Beam: 30									
Location	Characteristic loads G+Q			Quasi-permanent loads G+ψ2Q			Steel for		
	Moment	steel	concrete	Moment	concrete	Crack	cracking		
	stress/fyk	stress/fck		stress/fck	spacing	width	min provd		
	(kNm)			(kNm)	(mm)	(mm ²)			
L end top	75.1	0.422	0.283	63.6	0.240	198.6	0.11	661	722
Midspan	39.3	0.586	0.059	33.4	0.050	321.8	0.24	62	311
R end top	100.2	0.563	0.378	85.0	0.320	205.2	0.15	463	722

Beam: 29									
Location	Characteristic loads G+Q			Quasi-permanent loads G+ψ2Q			Steel for		
	Moment	steel	concrete	Moment	concrete	Crack	cracking		
	stress/fyk	stress/fck		stress/fck	spacing	width	min provd		
	(kNm)			(kNm)	(mm)	(mm ²)			
L end top	124.3	0.586	0.445	105.5	0.378	187.3	0.14	659	914
Midspan	73.0	0.735	0.089	61.9	0.076	277.9	0.26	62	464
R end top	117.4	0.578	0.425	99.5	0.361	212.7	0.16	543	863

 * STOREY: -1 * BEAMS: 31 30 29

* Concrete: C25 - Long. Reinforcement: S500 - Stirrups: S500 - Cover: 35 (mm) *

GEOMETRY - BENDING MOMENTS MED - LONGITUDINAL REINFORCEMENT

+-----+							
Beam: 31 Length l: 6.60m X-section T Depth h: 0.50m Width bw: 0.25m							

Top flange thickness (m): 0.18 (L end) 0.18 (centre) 0.18 (R end)							

Location	Effect.	max MEd	Required	Beam bars	Provided	Flexural	
	fl width		steel area	Contin Addit	steel area	capacity	
-----+---(m)---+---(kNm)---+---(mm2)---+-----+---(mm2)---+---(kNm)---							
L end top	0.25	108.1	599.	2Φ10 2Φ16	559.	101.4	
L end bot.	0.67	-67.9	149.	2Φ10 --	157.	30.3	
midspan	2.63	57.2	295.	2Φ10 1Φ14	311.	60.2	
R end top	0.25	103.8	573.	2Φ10 2Φ16	760.	134.3	
R end bot.	1.09	-66.0	149.	2Φ10 --	157.	30.4	

+-----+							
Beam: 30 Length l: 6.60m X-section T Depth h: 0.50m Width bw: 0.25m							

Top flange thickness (m): 0.18 (L end) 0.18 (centre) 0.18 (R end)							

Location	Effect.	max MEd	Required	Beam bars	Provided	Flexural	
	fl width		steel area	Contin Addit	steel area	capacity	
-----+---(m)---+---(kNm)---+---(mm2)---+-----+---(mm2)---+---(kNm)---							
L end top	0.25	102.0	563.	2Φ10 2Φ16	760.	134.3	
L end bot.	1.09	-65.7	149.	2Φ10 --	157.	30.4	
midspan	2.63	52.0	269.	2Φ10 1Φ14	311.	60.2	
R end top	0.25	120.3	673.	2Φ10 2Φ18	666.	119.1	
R end bot.	0.67	-77.6	149.	2Φ10 --	157.	30.3	

+-----+							
Beam: 29 Length l: 6.70m X-section T Depth h: 0.50m Width bw: 0.25m							

Top flange thickness (m): 0.18 (L end) 0.18 (centre) 0.18 (R end)							

Location	Effect.	max MEd	Required	Beam bars	Provided	Flexural	
	fl width		steel area	Contin Addit	steel area	capacity	
-----+---(m)---+---(kNm)---+---(mm2)---+-----+---(mm2)---+---(kNm)---							

L end top	0.25	162.6	943.	3Φ10	3Φ18	999.	174.0	
L end bot.	1.09	-102.4	149.	2Φ10	--	157.	30.4	
midspan	2.63	89.4	462.	2Φ10	2Φ14	465.	89.9	
R end top	0.25	156.9	905.	3Φ10	2Φ20	864.	150.5	
R end bot.	0.67	-99.6	149.	2Φ10	--	157.	30.3	

SLS CHECKS: STRESS LIMITS, CRACK WIDTH CONTROL FOR Wmax=0.3mm & min STEEL AREA

Beam: 31									
Location	Characteristic loads G+Q	Quasi-permanent loads G+ψ2Q	Steel for						
	Moment steel	concrete	Moment concrete	Crack	cracking				
	stress/fyk	stress/fck	stress/fck	spacing	width	min provd			
	(kNm)		(kNm)	(mm)		(mm2)			
L end top	84.1	0.651	0.351	71.4	0.298	240.8	0.20	501	559
Midspan	44.5	0.663	0.067	37.8	0.057	321.8	0.27	62	311
R end top	80.8	0.487	0.311	68.5	0.264	209.7	0.13	731	760

Beam: 30									
Location	Characteristic loads G+Q	Quasi-permanent loads G+ψ2Q	Steel for						
	Moment steel	concrete	Moment concrete	Crack	cracking				
	stress/fyk	stress/fck	stress/fck	spacing	width	min provd			
	(kNm)		(kNm)	(mm)		(mm2)			
L end top	79.4	0.430	0.296	67.3	0.251	207.9	0.11	731	760
Midspan	40.5	0.603	0.061	34.4	0.051	321.8	0.25	62	311
R end top	93.6	0.558	0.359	79.4	0.305	230.9	0.16	531	666

Beam: 29									
Location	Characteristic loads G+Q	Quasi-permanent loads G+ψ2Q	Steel for						
	Moment steel	concrete	Moment concrete	Crack	cracking				
	stress/fyk	stress/fck	stress/fck	spacing	width	min provd			
	(kNm)		(kNm)	(mm)		(mm2)			
L end top	126.5	0.557	0.444	107.4	0.377	196.0	0.14	758	999
Midspan	69.6	0.700	0.085	59.0	0.072	277.9	0.25	62	464
R end top	122.1	0.601	0.442	103.5	0.375	212.7	0.16	543	863

3A 2. DESIGN OF COLUMNS

3A 2.1. COLUMN C1

```

*-----*
* COLUMN: 1 *
*-----*
* Concrete: C25 - Long. Reinforcement: S500 - Stirrups: S500 - Cover: 35 (mm) *
*-----*
                NORMAL STRESS-RESULTANTS
*-----*
| STOREY: 6 | Base | Top |
|Actions Combination| My Mz N | My Mz N |
|-----+---- (kNm) ---- (kNm) ---- (kN) -+---- (kNm) ---- (kNm) ---- (kN) -|
| EN1990 Eq. 6.10a | -27.5 19.6 116.9 | 33.5 -28.5 95.6 |
| EN1990 Eq. 6.10b | -26.2 18.7 109.1 | 31.9 -27.1 91.1 |
| G+ψ2Q+E +X +Y/maxN| 34.3 127.5 150.8 | 84.5 150.7 135.0 |
| G+ψ2Q+E -X +Y/maxN| -70.6 127.5 150.8 | -40.3 150.7 135.0 |
| G+ψ2Q+E +X -Y/maxN| 34.3 -101.5 150.8 | 84.5 -188.5 135.0 |
| G+ψ2Q+E -X -Y/maxN| -70.6 -101.5 150.8 | -40.3 -188.5 135.0 |
| G+ψ2Q+E +X +Y/minN| 34.3 127.5 7.0 | 84.5 150.7 -8.7 |
| G+ψ2Q+E -X +Y/minN| -70.6 127.5 7.0 | -40.3 150.7 -8.7 |
| G+ψ2Q+E +X -Y/minN| 34.3 -101.5 7.0 | 84.5 -188.5 -8.7 |
| G+ψ2Q+E -X -Y/minN| -70.6 -101.5 7.0 | -40.3 -188.5 -8.7 |
+-----+
| STOREY: 5 | Base | Top |
|Actions Combination| My Mz N | My Mz N |
|-----+---- (kNm) ---- (kNm) ---- (kN) -+---- (kNm) ---- (kNm) ---- (kN) -|
| EN1990 Eq. 6.10a | -23.1 15.8 239.4 | 22.4 -14.0 218.1 |
| EN1990 Eq. 6.10b | -22.0 15.0 223.6 | 21.3 -13.3 205.5 |
| G+ψ2Q+E +X +Y/maxN| 37.2 110.0 318.8 | 67.8 83.8 303.0 |
| G+ψ2Q+E -X +Y/maxN| -67.6 110.0 318.8 | -38.3 83.8 303.0 |
| G+ψ2Q+E +X -Y/maxN| 37.2 -89.1 318.8 | 67.8 -102.3 303.0 |
| G+ψ2Q+E -X -Y/maxN| -67.6 -89.1 318.8 | -38.3 -102.3 303.0 |
| G+ψ2Q+E +X +Y/minN| 37.2 110.0 4.2 | 67.8 83.8 -11.5 |
| G+ψ2Q+E -X +Y/minN| -67.6 110.0 4.2 | -38.3 83.8 -11.5 |
| G+ψ2Q+E +X -Y/minN| 37.2 -89.1 4.2 | 67.8 -102.3 -11.5 |
| G+ψ2Q+E -X -Y/minN| -67.6 -89.1 4.2 | -38.3 -102.3 -11.5 |
+-----+
| STOREY: 4 | Base | Top |
|Actions Combination| My Mz N | My Mz N |
|-----+---- (kNm) ---- (kNm) ---- (kN) -+---- (kNm) ---- (kNm) ---- (kN) -|

```

EN1990 Eq. 6.10a	-23.0	17.3	360.9		23.4	-17.5	339.7	
EN1990 Eq. 6.10b	-21.9	16.4	337.2		22.3	-16.6	319.1	
G+ψ2Q+E +X +Y/maxN	41.3	120.6	486.5		72.5	95.2	470.7	
G+ψ2Q+E -X +Y/maxN	-71.7	120.6	486.5		-41.6	95.2	470.7	
G+ψ2Q+E +X -Y/maxN	41.3	-97.8	486.5		72.5	-118.4	470.7	
G+ψ2Q+E -X -Y/maxN	-71.7	-97.8	486.5		-41.6	-118.4	470.7	
G+ψ2Q+E +X +Y/minN	41.3	120.6	0.5		72.5	95.2	-15.3	
G+ψ2Q+E -X +Y/minN	-71.7	120.6	0.5		-41.6	95.2	-15.3	
G+ψ2Q+E +X -Y/minN	41.3	-97.8	0.5		72.5	-118.4	-15.3	
G+ψ2Q+E -X -Y/minN	-71.7	-97.8	0.5		-41.6	-118.4	-15.3	

-----+

STOREY: 3	Base				Top			
Actions Combination	My	Mz	N		My	Mz	N	
-----+-----	(kNm)	(kNm)	(kN)		(kNm)	(kNm)	(kN)	
EN1990 Eq. 6.10a	-21.5	16.7	482.5		22.1	-17.3	461.2	
EN1990 Eq. 6.10b	-20.5	15.9	450.7		21.0	-16.4	432.6	
G+ψ2Q+E +X +Y/maxN	42.7	120.2	652.3		70.8	81.5	636.5	
G+ψ2Q+E -X +Y/maxN	-71.1	120.2	652.3		-41.6	81.5	636.5	
G+ψ2Q+E +X -Y/maxN	42.7	-98.1	652.3		70.8	-104.4	636.5	
G+ψ2Q+E -X -Y/maxN	-71.1	-98.1	652.3		-41.6	-104.4	636.5	
G+ψ2Q+E +X +Y/minN	42.7	120.2	-1.4		70.8	81.5	-17.2	
G+ψ2Q+E -X +Y/minN	-71.1	120.2	-1.4		-41.6	81.5	-17.2	
G+ψ2Q+E +X -Y/minN	42.7	-98.1	-1.4		70.8	-104.4	-17.2	
G+ψ2Q+E -X -Y/minN	-71.1	-98.1	-1.4		-41.6	-104.4	-17.2	

-----+

STOREY: 2	Base				Top			
Actions Combination	My	Mz	N		My	Mz	N	
-----+-----	(kNm)	(kNm)	(kN)		(kNm)	(kNm)	(kN)	
EN1990 Eq. 6.10a	-23.5	22.7	604.1		22.2	-19.7	582.8	
EN1990 Eq. 6.10b	-22.4	21.6	564.3		21.1	-18.7	546.3	
G+ψ2Q+E +X +Y/maxN	40.7	116.4	809.4		66.7	57.9	793.7	
G+ψ2Q+E -X +Y/maxN	-71.8	116.4	809.4		-37.4	57.9	793.7	
G+ψ2Q+E +X -Y/maxN	40.7	-86.4	809.4		66.7	-83.9	793.7	
G+ψ2Q+E -X -Y/maxN	-71.8	-86.4	809.4		-37.4	-83.9	793.7	
G+ψ2Q+E +X +Y/minN	40.7	116.4	5.5		66.7	57.9	-10.2	
G+ψ2Q+E -X +Y/minN	-71.8	116.4	5.5		-37.4	57.9	-10.2	
G+ψ2Q+E +X -Y/minN	40.7	-86.4	5.5		66.7	-83.9	-10.2	
G+ψ2Q+E -X -Y/minN	-71.8	-86.4	5.5		-37.4	-83.9	-10.2	

-----+

STOREY: 1	Base				Top			
Actions Combination	My	Mz	N		My	Mz	N	
-----+-----	(kNm)	(kNm)	(kN)		(kNm)	(kNm)	(kN)	

EN1990 Eq. 6.10a		-6.2	6.1	730.9		12.6	-14.0	702.6	
EN1990 Eq. 6.10b		-5.9	5.8	682.2		12.0	-13.3	658.1	
G+ψ2Q+E +X +Y/maxN		44.8	112.8	953.4		44.2	25.7	932.4	
G+ψ2Q+E -X +Y/maxN		-53.0	112.8	953.4		-27.6	25.7	932.4	
G+ψ2Q+E +X -Y/maxN		44.8	-104.7	953.4		44.2	-44.2	932.4	
G+ψ2Q+E -X -Y/maxN		-53.0	-104.7	953.4		-27.6	-44.2	932.4	
G+ψ2Q+E +X +Y/minN		44.8	112.8	33.6		44.2	25.7	12.6	
G+ψ2Q+E -X +Y/minN		-53.0	112.8	33.6		-27.6	25.7	12.6	
G+ψ2Q+E +X -Y/minN		44.8	-104.7	33.6		44.2	-44.2	12.6	
G+ψ2Q+E -X -Y/minN		-53.0	-104.7	33.6		-27.6	-44.2	12.6	

FOR NEGLIGIBLE 2ND-ORDER EFFECTS IN COLUMN, per EC2 pa.5.8.3.1, 5.8.3.2, 5.8.7.2

Storey	Combination	column direction x				column direction z			
		of actions	slenderness	column	slenderness	column	slenderness	column	
per EN1990		limit	actual	eff.10	req.size	limit	actual	eff.10	req.size
		(m)				(m)			
6	Eq. 6.10a	276.4	17.4	1.50	0.30	261.8	8.0	1.62	0.70
	Eq. 6.10b	279.6	17.4	1.50	0.30	264.6	8.0	1.62	0.70
5	Eq. 6.10a	179.6	17.1	1.48	0.30	171.7	8.0	1.61	0.70
	Eq. 6.10b	183.2	17.1	1.48	0.30	175.0	8.0	1.61	0.70
4	Eq. 6.10a	160.9	17.1	1.48	0.30	160.9	8.0	1.61	0.70
	Eq. 6.10b	164.0	17.1	1.48	0.30	163.9	8.0	1.61	0.70
3	Eq. 6.10a	138.7	17.2	1.49	0.30	138.3	8.0	1.62	0.70
	Eq. 6.10b	141.5	17.2	1.49	0.30	141.1	8.0	1.62	0.70
2	Eq. 6.10a	123.2	17.2	1.49	0.30	124.8	8.1	1.63	0.70
	Eq. 6.10b	126.1	17.2	1.49	0.30	127.9	8.1	1.63	0.70
1	Eq. 6.10a	93.6	23.6	2.05	0.30	91.0	11.2	2.27	0.70
	Eq. 6.10b	95.6	23.6	2.04	0.30	92.9	11.2	2.26	0.70

GEOMETRY & LONGITUDINAL REINFORCEMENT

| Storey 6 Clear height (m) : 2.50 hcr (m) : 0.70 X-sect. RECT by (m) : 0.70 bz (m) : 0.30 |

| Vertical steel ratio: 0.0097, Bars: 4Φ16 & 8Φ14 |

| 2Φ16 & 3Φ14 along by 2Φ16 & 1Φ14 along bz |

```

|Storey 5 Clear height(m):2.50 hcr(m):0.70 X-sect. RECT by(m):0.70 bz(m):0.30|
+-----+
| Vertical steel ratio: 0.0097, Bars: 4Φ16 & 8Φ14 |
|           2Φ16 & 3Φ14 along by 2Φ16 & 1Φ14 along bz |
+-----+
|Storey 4 Clear height(m):2.50 hcr(m):0.70 X-sect. RECT by(m):0.70 bz(m):0.30|
+-----+
| Vertical steel ratio: 0.0097, Bars: 4Φ16 & 8Φ14 |
|           2Φ16 & 3Φ14 along by 2Φ16 & 1Φ14 along bz |
+-----+
|Storey 3 Clear height(m):2.50 hcr(m):0.70 X-sect. RECT by(m):0.70 bz(m):0.30|
+-----+
| Vertical steel ratio: 0.0097, Bars: 4Φ16 & 8Φ14 |
|           2Φ16 & 3Φ14 along by 2Φ16 & 1Φ14 along bz |
+-----+
|Storey 2 Clear height(m):2.50 hcr(m):0.70 X-sect. RECT by(m):0.70 bz(m):0.30|
+-----+
| Vertical steel ratio: 0.0097, Bars: 4Φ16 & 8Φ14 |
|           2Φ16 & 3Φ14 along by 2Φ16 & 1Φ14 along bz |
+-----+
|Storey 1 Clear height(m):3.50 hcr(m):0.70 X-sect. RECT by(m):0.70 bz(m):0.30|
+-----+
| Vertical steel ratio: 0.0097, Bars: 4Φ16 & 8Φ14 |
|           2Φ16 & 3Φ14 along by 2Φ16 & 1Φ14 along bz |
+-----+
|Starter bars at base: 4Φ16 & 8Φ14 |
|           2Φ16 & 3Φ14 along by 2Φ16 & 1Φ14 along bz |
+-----+

```

COLUMN DESIGN MOMENT RESISTANCE MRd,c (for minN/maxN)

Storey	Locat.	Direction of MRd Vector :							
		+y		-y		+z		-z	
		(kNm)		(kNm)		(kNm)		(kNm)	
6	Top	84.0/	102.9	-84.0/	-102.9	340.8/	369.5	-340.8/	-369.5
	Base	86.2/	104.8	-86.2/	-104.8	344.1/	372.4	-344.1/	-372.4
5	Top	83.6/	121.7	-83.6/	-121.7	340.2/	399.2	-340.2/	-399.2
	Base	85.9/	123.3	-85.9/	-123.3	343.5/	401.7	-343.5/	-401.7
4	Top	83.1/	137.5	-83.1/	-137.5	339.5/	424.7	-339.5/	-424.7
	Base	85.3/	138.8	-85.3/	-138.8	342.8/	426.9	-342.8/	-426.9

3	Top	82.8/ 150.6	-82.8/ -150.6	339.0/ 446.0	-339.0/ -446.0
	Base	85.1/ 151.7	-85.1/ -151.7	342.4/ 447.9	-342.4/ -447.9
+-----+					
2	Top	83.8/ 160.9	-83.8/ -160.9	340.5/ 462.6	-340.5/ -462.6
	Base	86.0/ 161.8	-86.0/ -161.8	343.8/ 464.0	-343.8/ -464.0
+-----+					
1	Top	87.0/ 168.4	-87.0/ -168.4	345.3/ 474.2	-345.3/ -474.2
	Base	89.9/ 169.4	-89.9/ -169.4	349.6/ 475.7	-349.6/ -475.7
+-----+					

SUM OF BEAM DESIGN MOMENT RESISTANCES, MRd,b, AROUND JOINT

Storey	Locat.	Direction of MRd Vector :			
		+y	-y	+z	-z
		(kNm)	(kNm)	(kNm)	(kNm)
6	Top	83.4	58.5	188.3	170.8
	Base	134.6	86.9	232.7	223.2
+-----+					
5	Top	134.6	86.9	232.7	223.2
	Base	134.6	86.9	232.7	223.2
+-----+					
4	Top	134.6	86.9	232.7	223.2
	Base	139.5	86.9	232.7	223.2
+-----+					
3	Top	139.5	86.9	232.7	223.2
	Base	134.6	86.9	204.1	170.8
+-----+					
2	Top	134.6	86.9	204.1	170.8
	Base	149.3	86.9	158.0	116.0
+-----+					
1	Top	149.3	86.9	158.0	116.0
	Base	0.0	0.0	0.0	0.0
+-----+					

DESIGN OF TRANSVERSE REINFORCEMENT IN SHEAR (for maxN/minN)

Storey	Des. Shear VEd (kN)	Provided Ties		strut angle (deg)	VR,s		VR,max						
		dia.	legs		(middle-kN)	(middle-kN)							
		spacing-s (mm)	spacing-s middle-mm	(deg)	y	z	y	z					
6	maxN	37.	83.	6	5.0	3.0	170	22	22	216.	354.	490.	545.
	minN	37.	83.					22	22	203.	315.	490.	545.
+-----+													
5	maxN	32.	78.	6	5.0	3.0	170	22	22	229.	394.	490.	545.

minN	30.	76.		22	22	203.	315.		490.	545.					
+-----+															
4 maxN	31.	77.	6	5.0	3.0	170		22	22	243.	434.		490.	545.	
minN	30.	76.		22	22	203.	314.		490.	545.					
+-----+															
3 maxN	32.	77.	6	5.0	3.0	170		22	22	256.	474.		490.	545.	
minN	31.	76.		22	22	202.	313.		490.	545.					
+-----+															
2 maxN	31.	67.	6	5.0	3.0	170		22	22	269.	512.		490.	545.	
minN	30.	67.		22	22	203.	315.		490.	545.					
+-----+															
1 maxN	77.	187.	6	5.0	3.0	170		22	22	259.	481.		490.	545.	
minN	52.	147.		22	22	205.	320.		490.	545.					
+-----+															

CONFINEMENT REINFORCEMENT AT COLUMN ENDS (for maxN/minN)

Story	Wwd-req.		aWwd-req.		Stirrups					Wwd-prov.		aWwd-prov.	
	base	top	base	top	dia.	legs	spacing-mm	base	top	base	top		
				(mm)	y	z	base	top					
6	0.00	0.00	0.000	0.000	6	5.0	3.0	110	110	0.177	0.177	0.055	0.055
5	0.00	0.00	0.000	0.000	6	5.0	3.0	110	110	0.177	0.177	0.055	0.055
4	0.00	0.00	0.000	0.000	6	5.0	3.0	110	110	0.177	0.177	0.055	0.055
3	0.00	0.00	0.000	0.000	6	5.0	3.0	110	110	0.177	0.177	0.055	0.055
2	0.00	0.00	0.000	0.000	6	5.0	3.0	110	110	0.177	0.177	0.055	0.055
1	0.08	0.00	0.086	0.000	6	5.0	3.0	80	110	0.243	0.177	0.088	0.055

3A 2.2. COLUMN C2

```

*-----*
* COLUMN: 2 *
*-----*
* Concrete: C25 - Long. Reinforcement: S500 - Stirrups: S500 - Cover: 35 (mm) *
*-----*

```

NORMAL STRESS-RESULTANTS

STOREY: 6	Base			Top			
Actions Combination	My	Mz	N	My	Mz	N	
-----+-----	(kNm)	(kNm)	(kN)	+-----	(kNm)	(kNm)	----- (kN) -
EN1990 Eq. 6.10a	0.2	77.7	260.2		-3.1	-93.0	239.0
EN1990 Eq. 6.10b	0.2	73.9	245.7		-3.0	-88.5	227.6
G+ψ2Q+E +X +Y/maxN	122.9	98.4	192.5		169.1	-6.6	176.7
G+ψ2Q+E -X +Y/maxN	-122.7	98.4	192.5		-173.2	-6.6	176.7
G+ψ2Q+E +X -Y/maxN	122.9	4.2	192.5		169.1	-116.3	176.7
G+ψ2Q+E -X -Y/maxN	-122.7	4.2	192.5		-173.2	-116.3	176.7
G+ψ2Q+E +X +Y/minN	122.9	98.4	154.6		169.1	-6.6	138.8
G+ψ2Q+E -X +Y/minN	-122.7	98.4	154.6		-173.2	-6.6	138.8
G+ψ2Q+E +X -Y/minN	122.9	4.2	154.6		169.1	-116.3	138.8
G+ψ2Q+E -X -Y/minN	-122.7	4.2	154.6		-173.2	-116.3	138.8
+-----+							
STOREY: 5	Base			Top			
Actions Combination	My	Mz	N	My	Mz	N	
-----+-----	(kNm)	(kNm)	(kN)	+-----	(kNm)	(kNm)	----- (kN) -
EN1990 Eq. 6.10a	-0.6	66.6	526.4		1.5	-64.7	505.2
EN1990 Eq. 6.10b	-0.5	63.4	497.0		1.4	-61.6	478.9
G+ψ2Q+E +X +Y/maxN	122.8	88.0	398.6		131.1	0.7	382.9
G+ψ2Q+E -X +Y/maxN	-123.6	88.0	398.6		-129.2	0.7	382.9
G+ψ2Q+E +X -Y/maxN	122.8	0.0	398.6		131.1	-86.2	382.9
G+ψ2Q+E -X -Y/maxN	-123.6	0.0	398.6		-129.2	-86.2	382.9
G+ψ2Q+E +X +Y/minN	122.8	88.0	303.3		131.1	0.7	287.6
G+ψ2Q+E -X +Y/minN	-123.6	88.0	303.3		-129.2	0.7	287.6
G+ψ2Q+E +X -Y/minN	122.8	0.0	303.3		131.1	-86.2	287.6
G+ψ2Q+E -X -Y/minN	-123.6	0.0	303.3		-129.2	-86.2	287.6
+-----+							
STOREY: 4	Base			Top			
Actions Combination	My	Mz	N	My	Mz	N	
-----+-----	(kNm)	(kNm)	(kN)	+-----	(kNm)	(kNm)	----- (kN) -
EN1990 Eq. 6.10a	0.3	67.5	792.1		-0.2	-68.0	770.9
EN1990 Eq. 6.10b	0.3	64.3	747.9		-0.2	-64.7	729.8
G+ψ2Q+E +X +Y/maxN	136.6	89.8	603.8		141.2	-0.2	588.1
G+ψ2Q+E -X +Y/maxN	-136.2	89.8	603.8		-141.5	-0.2	588.1
G+ψ2Q+E +X -Y/maxN	136.6	-0.6	603.8		141.2	-89.6	588.1
G+ψ2Q+E -X -Y/maxN	-136.2	-0.6	603.8		-141.5	-89.6	588.1
G+ψ2Q+E +X +Y/minN	136.6	89.8	452.4		141.2	-0.2	436.7
G+ψ2Q+E -X +Y/minN	-136.2	89.8	452.4		-141.5	-0.2	436.7
G+ψ2Q+E +X -Y/minN	136.6	-0.6	452.4		141.2	-89.6	436.7

G+ψ2Q+E -X -Y/minN	-136.2	-0.6	452.4		-141.5	-89.6	436.7	
+-----+								
STOREY: 3	Base				Top			
Actions Combination	My	Mz	N		My	Mz	N	
-----+	(kNm)	(kNm)	(kN)		(kNm)	(kNm)	(kN)	
EN1990 Eq. 6.10a	0.4	65.2	1058.2		-0.4	-66.2	1037.0	
EN1990 Eq. 6.10b	0.4	62.1	999.1		-0.4	-63.0	981.0	
G+ψ2Q+E +X +Y/maxN	145.1	86.2	808.4		136.7	-2.5	792.6	
G+ψ2Q+E -X +Y/maxN	-144.5	86.2	808.4		-137.2	-2.5	792.6	
G+ψ2Q+E +X -Y/maxN	145.1	0.0	808.4		136.7	-85.0	792.6	
G+ψ2Q+E -X -Y/maxN	-144.5	0.0	808.4		-137.2	-85.0	792.6	
G+ψ2Q+E +X +Y/minN	145.1	86.2	602.7		136.7	-2.5	586.9	
G+ψ2Q+E -X +Y/minN	-144.5	86.2	602.7		-137.2	-2.5	586.9	
G+ψ2Q+E +X -Y/minN	145.1	0.0	602.7		136.7	-85.0	586.9	
G+ψ2Q+E -X -Y/minN	-144.5	0.0	602.7		-137.2	-85.0	586.9	
+-----+								
STOREY: 2	Base				Top			
Actions Combination	My	Mz	N		My	Mz	N	
-----+	(kNm)	(kNm)	(kN)		(kNm)	(kNm)	(kN)	
EN1990 Eq. 6.10a	3.0	72.8	1325.0		-1.6	-68.6	1303.8	
EN1990 Eq. 6.10b	2.8	69.3	1251.0		-1.5	-65.3	1233.0	
G+ψ2Q+E +X +Y/maxN	134.9	87.1	1010.4		116.2	-10.8	994.7	
G+ψ2Q+E -X +Y/maxN	-131.0	87.1	1010.4		-118.3	-10.8	994.7	
G+ψ2Q+E +X -Y/maxN	134.9	9.1	1010.4		116.2	-79.7	994.7	
G+ψ2Q+E -X -Y/maxN	-131.0	9.1	1010.4		-118.3	-79.7	994.7	
G+ψ2Q+E +X +Y/minN	134.9	87.1	756.4		116.2	-10.8	740.7	
G+ψ2Q+E -X +Y/minN	-131.0	87.1	756.4		-118.3	-10.8	740.7	
G+ψ2Q+E +X -Y/minN	134.9	9.1	756.4		116.2	-79.7	740.7	
G+ψ2Q+E -X -Y/minN	-131.0	9.1	756.4		-118.3	-79.7	740.7	
+-----+								
STOREY: 1	Base				Top			
Actions Combination	My	Mz	N		My	Mz	N	
-----+	(kNm)	(kNm)	(kN)		(kNm)	(kNm)	(kN)	
EN1990 Eq. 6.10a	1.0	26.7	1597.6		-2.2	-42.8	1569.2	
EN1990 Eq. 6.10b	1.0	25.4	1507.7		-2.1	-40.7	1483.6	
G+ψ2Q+E +X +Y/maxN	215.5	40.3	1210.1		99.9	-12.5	1189.1	
G+ψ2Q+E -X +Y/maxN	-214.2	40.3	1210.1		-102.8	-12.5	1189.1	
G+ψ2Q+E +X -Y/maxN	215.5	-5.0	1210.1		99.9	-44.0	1189.1	
G+ψ2Q+E -X -Y/maxN	-214.2	-5.0	1210.1		-102.8	-44.0	1189.1	
G+ψ2Q+E +X +Y/minN	215.5	40.3	921.2		99.9	-12.5	900.2	
G+ψ2Q+E -X +Y/minN	-214.2	40.3	921.2		-102.8	-12.5	900.2	
G+ψ2Q+E +X -Y/minN	215.5	-5.0	921.2		99.9	-44.0	900.2	

G+ψ2Q+E -X -Y/minN -214.2 -5.0 921.2 -102.8 -44.0 900.2									
+-----+ FOR NEGLIGIBLE 2ND-ORDER EFFECTS IN COLUMN, per EC2 pa.5.8.3.1, 5.8.3.2, 5.8.7.2 +-----+									
Storey	Combination	column direction x				column direction z			
		of actions	slenderness	column	eff.10 req.size	slenderness	column	eff.10 req.size	
per EN1990		limit	actual	eff.10	req.size	limit	actual	eff.10	req.size
+-----+-----+-----+-----+ (m) -----+-----+-----+-----+ (m) -----+									
6	Eq. 6.10a	121.6	8.0	1.61	0.70	175.9	17.4	1.50	0.30
	Eq. 6.10b	123.0	8.0	1.61	0.70	177.9	17.3	1.50	0.30
5	Eq. 6.10a	101.2	7.9	1.60	0.70	121.9	17.2	1.49	0.30
	Eq. 6.10b	102.6	7.9	1.60	0.70	123.7	17.2	1.49	0.30
4	Eq. 6.10a	81.4	7.9	1.60	0.70	107.1	17.3	1.50	0.30
	Eq. 6.10b	82.3	7.9	1.60	0.70	108.7	17.3	1.50	0.30
3	Eq. 6.10a	96.2	7.9	1.60	0.70	92.9	17.5	1.52	0.30
	Eq. 6.10b	98.1	7.9	1.60	0.70	94.4	17.5	1.51	0.30
2	Eq. 6.10a	85.9	8.0	1.61	0.70	83.5	17.8	1.54	0.30
	Eq. 6.10b	88.3	8.0	1.61	0.70	85.0	17.8	1.54	0.30
1	Eq. 6.10a	61.6	11.1	2.24	0.70	66.3	24.9	2.16	0.30
	Eq. 6.10b	62.7	11.1	2.24	0.70	67.4	24.8	2.15	0.30

GEOMETRY & LONGITUDINAL REINFORCEMENT

Storey 6	Clear height(m):2.50	hcr(m):0.70	X-sect. RECT by(m):0.30	bz(m):0.70
Vertical steel ratio:	0.0097,	Bars:	4Φ16 & 8Φ14	
		2Φ16 & 1Φ14 along by	2Φ16 & 3Φ14 along bz	
Storey 5	Clear height(m):2.50	hcr(m):0.70	X-sect. RECT by(m):0.30	bz(m):0.70
Vertical steel ratio:	0.0097,	Bars:	4Φ16 & 8Φ14	
		2Φ16 & 1Φ14 along by	2Φ16 & 3Φ14 along bz	
Storey 4	Clear height(m):2.50	hcr(m):0.70	X-sect. RECT by(m):0.30	bz(m):0.70
Vertical steel ratio:	0.0097,	Bars:	4Φ16 & 8Φ14	
		2Φ16 & 1Φ14 along by	2Φ16 & 3Φ14 along bz	

+-----+									
Storey 3 Clear height(m):2.50 hcr(m):0.70 X-sect. RECT by(m):0.30 bz(m):0.70									
+-----+									
Vertical steel ratio: 0.0097, Bars: 4Φ16 & 8Φ14									
2Φ16 & 1Φ14 along by 2Φ16 & 3Φ14 along bz									
+-----+									
Storey 2 Clear height(m):2.50 hcr(m):0.70 X-sect. RECT by(m):0.30 bz(m):0.70									
+-----+									
Vertical steel ratio: 0.0097, Bars: 4Φ16 & 8Φ14									
2Φ16 & 1Φ14 along by 2Φ16 & 3Φ14 along bz									
+-----+									
Storey 1 Clear height(m):3.50 hcr(m):0.70 X-sect. RECT by(m):0.30 bz(m):0.70									
+-----+									
Vertical steel ratio: 0.0097, Bars: 4Φ16 & 8Φ14									
2Φ16 & 1Φ14 along by 2Φ16 & 3Φ14 along bz									
+-----+									
Starter bars at base: 4Φ16 & 8Φ14									
2Φ16 & 1Φ14 along by 2Φ16 & 3Φ14 along bz									
+-----+									
COLUMN DESIGN MOMENT RESISTANCE MRd,c (for minN/maxN)									
+-----+									
Storey	Locat.	Direction of MRd Vector :							
		+y	-y	+z	-z				
+-----+	+-----+	+----- (kNm)	+----- (kNm)	+----- (kNm)	+----- (kNm)	+-----+	+-----+	+-----+	+-----+
6	Top	370.2/ 377.2	-370.2/ -377.2	103.3/ 107.8	-103.3/ -107.8				
	Base	373.1/ 380.1	-373.1/ -380.1	105.2/ 109.7	-105.2/ -109.7				
+-----+									
5	Top	396.6/ 411.9	-396.6/ -411.9	120.1/ 129.5	-120.1/ -129.5				
	Base	399.2/ 414.2	-399.2/ -414.2	121.7/ 131.0	-121.7/ -131.0				
+-----+									
4	Top	419.9/ 440.2	-419.9/ -440.2	134.5/ 147.0	-134.5/ -147.0				
	Base	422.2/ 442.2	-422.2/ -442.2	135.9/ 148.2	-135.9/ -148.2				
+-----+									
3	Top	440.1/ 462.5	-440.1/ -462.5	146.9/ 160.8	-146.9/ -160.8				
	Base	442.0/ 463.9	-442.0/ -463.9	148.1/ 161.7	-148.1/ -161.7				
+-----+									
2	Top	457.4/ 478.5	-457.4/ -478.5	157.6/ 171.2	-157.6/ -171.2				
	Base	459.0/ 479.5	-459.0/ -479.5	158.6/ 171.9	-158.6/ -171.9				
+-----+									
1	Top	471.7/ 488.4	-471.7/ -488.4	166.7/ 181.6	-166.7/ -181.6				
	Base	473.4/ 489.1	-473.4/ -489.1	167.8/ 181.8	-167.8/ -181.8				
+-----+									

SUM OF BEAM DESIGN MOMENT RESISTANCES, MRd,b, AROUND JOINT

Storey	Locat.	Direction of MRd Vector :			
		+y	-y	+z	-z
		(kNm)	(kNm)	(kNm)	(kNm)
6	Top	186.8	226.6	126.8	59.0
	Base	280.3	263.0	187.6	116.4
5	Top	280.3	263.0	187.6	116.4
	Base	310.9	272.6	187.6	116.4
4	Top	310.9	272.6	187.6	116.4
	Base	310.9	272.6	187.6	116.4
3	Top	310.9	272.6	187.6	116.4
	Base	310.9	272.6	162.0	87.9
2	Top	310.9	272.6	162.0	87.9
	Base	259.0	259.0	133.3	87.9
1	Top	259.0	259.0	133.3	87.9
	Base	0.0	0.0	0.0	0.0

DESIGN OF TRANSVERSE REINFORCEMENT IN SHEAR (for maxN/minN)

Storey	Des. Shear	Provided Ties				strut angle		VR,s		VR,max			
		VEd (kN)		dia. legs		spacing-s		(deg)		(middle-kN)			
		y	z	y	z	middle-mm	y	z	y	z	y	z	
6	maxN	100.	47.	6	3.0	5.0	170	22	22	364.	219.	545.	490.
	minN	100.	45.					22	22	351.	215.	545.	490.
5	maxN	64.	24.	6	3.0	5.0	170	22	22	413.	236.	545.	490.
	minN	64.	24.					22	22	387.	227.	545.	490.
4	maxN	71.	23.	6	3.0	5.0	170	22	22	463.	252.	545.	490.
	minN	70.	23.					22	22	422.	239.	545.	490.
3	maxN	70.	23.	6	3.0	5.0	170	22	22	512.	269.	545.	490.
	minN	70.	23.					22	22	459.	251.	545.	490.
2	maxN	70.	19.	6	3.0	5.0	170	22	22	551.	285.	556.	490.

	minN	70.	19.					22	22	496.	263.	545.	490.
1	maxN	195.	68.	6	3.0	5.0	170	22	22	525.	273.	545.	490.
	minN	190.	64.					22	22	472.	255.	545.	490.

CONFINEMENT REINFORCEMENT AT COLUMN ENDS (for maxN/minN)

Story	Wwd-req.		aWwd-req.		Stirrups					Wwd-prov.		aWwd-prov.	
	base top	base top	dia.	legs	spacing-mm	base top	base top			base top	base top		
			(mm)	y	z	base top			base top	base top			
6	0.00	0.00	0.000	0.000	6	3.0	5.0	110	110	0.177	0.177	0.055	0.055
5	0.00	0.00	0.000	0.000	6	3.0	5.0	110	110	0.177	0.177	0.055	0.055
4	0.00	0.00	0.000	0.000	6	3.0	5.0	110	110	0.177	0.177	0.055	0.055
3	0.00	0.00	0.000	0.000	6	3.0	5.0	110	110	0.177	0.177	0.055	0.055
2	0.00	0.00	0.000	0.000	6	3.0	5.0	110	110	0.177	0.177	0.055	0.055
1	0.08	0.00	0.140	0.000	8	3.0	5.0	85	110	0.407	0.315	0.144	0.098

3A 2.3. COLUMN C3

* COLUMN: 3 *

* Concrete: C25 - Long. Reinforcement: S500 - Stirrups: S500 - Cover: 35 (mm) *

NORMAL STRESS-RESULTANTS

STOREY:	6	Base			Top		
		Actions Combination	My	Mz	N	My	Mz
		(kNm)	(kNm)	(kN)	(kNm)	(kNm)	(kN)
EN1990 Eq. 6.10a		4.2	49.3	212.5	-5.9	-59.2	191.3
EN1990 Eq. 6.10b		4.0	46.9	200.2	-5.6	-56.3	182.2
G+ψ2Q+E +X +Y/maxN		133.0	77.5	158.1	177.9	13.2	142.3
G+ψ2Q+E -X +Y/maxN		-127.5	77.5	158.1	-185.7	13.2	142.3

G+ψ2Q+E +X -Y/maxN	133.0	-12.4	158.1		177.9	-91.4	142.3	
G+ψ2Q+E -X -Y/maxN	-127.5	-12.4	158.1		-185.7	-91.4	142.3	
G+ψ2Q+E +X +Y/minN	133.0	77.5	126.0		177.9	13.2	110.3	
G+ψ2Q+E -X +Y/minN	-127.5	77.5	126.0		-185.7	13.2	110.3	
G+ψ2Q+E +X -Y/minN	133.0	-12.4	126.0		177.9	-91.4	110.3	
G+ψ2Q+E -X -Y/minN	-127.5	-12.4	126.0		-185.7	-91.4	110.3	

-----+

STOREY: 5	Base			Top		
Actions Combination	My	Mz	N	My	Mz	N
-----+	(kNm)	(kNm)	(kN)	(kNm)	(kNm)	(kN)
EN1990 Eq. 6.10a	3.2	42.3	432.4	-3.0	-41.0	411.1
EN1990 Eq. 6.10b	3.0	40.2	407.4	-2.8	-39.0	389.3
G+ψ2Q+E +X +Y/maxN	131.4	69.8	330.6	133.6	14.3	314.8
G+ψ2Q+E -X +Y/maxN	-127.2	69.8	330.6	-137.5	14.3	314.8
G+ψ2Q+E +X -Y/maxN	131.4	-13.9	330.6	133.6	-68.4	314.8
G+ψ2Q+E -X -Y/maxN	-127.2	-13.9	330.6	-137.5	-68.4	314.8
G+ψ2Q+E +X +Y/minN	131.4	69.8	247.2	133.6	14.3	231.5
G+ψ2Q+E -X +Y/minN	-127.2	69.8	247.2	-137.5	14.3	231.5
G+ψ2Q+E +X -Y/minN	131.4	-13.9	247.2	133.6	-68.4	231.5
G+ψ2Q+E -X -Y/minN	-127.2	-13.9	247.2	-137.5	-68.4	231.5

-----+

STOREY: 4	Base			Top		
Actions Combination	My	Mz	N	My	Mz	N
-----+	(kNm)	(kNm)	(kN)	(kNm)	(kNm)	(kN)
EN1990 Eq. 6.10a	3.0	43.0	650.8	-3.2	-43.3	629.6
EN1990 Eq. 6.10b	2.8	40.9	613.3	-3.0	-41.2	595.2
G+ψ2Q+E +X +Y/maxN	145.1	71.4	501.6	146.0	13.8	485.8
G+ψ2Q+E -X +Y/maxN	-141.2	71.4	501.6	-150.2	13.8	485.8
G+ψ2Q+E +X -Y/maxN	145.1	-14.5	501.6	146.0	-71.0	485.8
G+ψ2Q+E -X -Y/maxN	-141.2	-14.5	501.6	-150.2	-71.0	485.8
G+ψ2Q+E +X +Y/minN	145.1	71.4	368.1	146.0	13.8	352.3
G+ψ2Q+E -X +Y/minN	-141.2	71.4	368.1	-150.2	13.8	352.3
G+ψ2Q+E +X -Y/minN	145.1	-14.5	368.1	146.0	-71.0	352.3
G+ψ2Q+E -X -Y/minN	-141.2	-14.5	368.1	-150.2	-71.0	352.3

-----+

STOREY: 3	Base			Top		
Actions Combination	My	Mz	N	My	Mz	N
-----+	(kNm)	(kNm)	(kN)	(kNm)	(kNm)	(kN)
EN1990 Eq. 6.10a	2.5	41.9	868.9	-2.7	-42.4	847.7
EN1990 Eq. 6.10b	2.4	39.8	818.8	-2.5	-40.3	800.7
G+ψ2Q+E +X +Y/maxN	152.2	68.4	671.7	141.5	11.0	655.9
G+ψ2Q+E -X +Y/maxN	-148.9	68.4	671.7	-145.0	11.0	655.9

	Eq. 6.10b	189.1	7.9	1.61	0.70	198.6	17.6	1.52	0.30
+-----+-----+-----+-----+-----+-----+-----+-----+-----+-----+									
5	Eq. 6.10a	127.8	7.9	1.60	0.70	134.5	17.5	1.52	0.30
	Eq. 6.10b	129.6	7.9	1.60	0.70	136.6	17.5	1.51	0.30
+-----+-----+-----+-----+-----+-----+-----+-----+-----+-----+									
4	Eq. 6.10a	116.2	7.9	1.60	0.70	118.5	17.6	1.53	0.30
	Eq. 6.10b	118.0	7.9	1.60	0.70	120.4	17.6	1.53	0.30
+-----+-----+-----+-----+-----+-----+-----+-----+-----+-----+									
3	Eq. 6.10a	100.7	7.9	1.60	0.70	102.8	17.8	1.54	0.30
	Eq. 6.10b	102.4	7.9	1.60	0.70	104.6	17.8	1.54	0.30
+-----+-----+-----+-----+-----+-----+-----+-----+-----+-----+									
2	Eq. 6.10a	90.9	7.9	1.60	0.70	92.2	18.0	1.56	0.30
	Eq. 6.10b	92.4	7.9	1.60	0.70	94.0	18.0	1.56	0.30
+-----+-----+-----+-----+-----+-----+-----+-----+-----+-----+									
1	Eq. 6.10a	68.9	11.0	2.22	0.70	76.0	25.2	2.18	0.30
	Eq. 6.10b	70.1	11.0	2.22	0.70	77.3	25.1	2.18	0.30
+-----+-----+-----+-----+-----+-----+-----+-----+-----+-----+									

GEOMETRY & LONGITUDINAL REINFORCEMENT

+-----+-----+-----+-----+-----+-----+-----+-----+-----+-----+									
Storey 6 Clear height(m):2.50 hcr(m):0.70 X-sect. RECT by(m):0.30 bz(m):0.70									
+-----+-----+-----+-----+-----+-----+-----+-----+-----+-----+									
Vertical steel ratio: 0.0097, Bars: 4Φ16 & 8Φ14									
2Φ16 & 1Φ14 along by 2Φ16 & 3Φ14 along bz									
+-----+-----+-----+-----+-----+-----+-----+-----+-----+-----+									
Storey 5 Clear height(m):2.50 hcr(m):0.70 X-sect. RECT by(m):0.30 bz(m):0.70									
+-----+-----+-----+-----+-----+-----+-----+-----+-----+-----+									
Vertical steel ratio: 0.0097, Bars: 4Φ16 & 8Φ14									
2Φ16 & 1Φ14 along by 2Φ16 & 3Φ14 along bz									
+-----+-----+-----+-----+-----+-----+-----+-----+-----+-----+									
Storey 4 Clear height(m):2.50 hcr(m):0.70 X-sect. RECT by(m):0.30 bz(m):0.70									
+-----+-----+-----+-----+-----+-----+-----+-----+-----+-----+									
Vertical steel ratio: 0.0097, Bars: 4Φ16 & 8Φ14									
2Φ16 & 1Φ14 along by 2Φ16 & 3Φ14 along bz									
+-----+-----+-----+-----+-----+-----+-----+-----+-----+-----+									
Storey 3 Clear height(m):2.50 hcr(m):0.70 X-sect. RECT by(m):0.30 bz(m):0.70									
+-----+-----+-----+-----+-----+-----+-----+-----+-----+-----+									
Vertical steel ratio: 0.0097, Bars: 4Φ16 & 8Φ14									
2Φ16 & 1Φ14 along by 2Φ16 & 3Φ14 along bz									
+-----+-----+-----+-----+-----+-----+-----+-----+-----+-----+									
Storey 2 Clear height(m):2.50 hcr(m):0.70 X-sect. RECT by(m):0.30 bz(m):0.70									
+-----+-----+-----+-----+-----+-----+-----+-----+-----+-----+									
Vertical steel ratio: 0.0097, Bars: 4Φ16 & 8Φ14									

```

|                2Φ16 & 1Φ14 along by 2Φ16 & 3Φ14 along bz                |
+-----+
|Storey 1 Clear height(m):3.50 hcr(m):0.70 X-sect. RECT by(m):0.30 bz(m):0.70|
+-----+
| Vertical steel ratio: 0.0097, Bars: 4Φ16 & 8Φ14                          |
|                2Φ16 & 1Φ14 along by 2Φ16 & 3Φ14 along bz                |
+-----+
|Starter bars at base: 4Φ16 & 8Φ14                                          |
|                2Φ16 & 1Φ14 along by 2Φ16 & 3Φ14 along bz                |
+-----+

```

COLUMN DESIGN MOMENT RESISTANCE MRd,c (for minN/maxN)

```

+-----+
|Storey|Locat.|                Direction of MRd Vector                :                |
|      |      |      +y      |      -y      |      +z      |      -z      |
+-----+-----+-----+-----+-----+-----+-----+-----+
|      |      |      (kNm)   |      (kNm)   |      (kNm)   |      (kNm)   |
+-----+-----+-----+-----+-----+-----+
|  6  | Top  | 364.7/ 370.8| -364.7/ -370.8| 99.8/ 103.8| -99.8/ -103.8|
|      | Base | 367.8/ 373.8| -367.8/ -373.8| 101.8/ 105.7| -101.8/ -105.7|
+-----+-----+-----+-----+-----+
|  5  | Top  | 387.0/ 401.1| -387.0/ -401.1| 114.0/ 122.9| -114.0/ -122.9|
|      | Base | 389.8/ 403.6| -389.8/ -403.6| 115.8/ 124.4| -115.8/ -124.4|
+-----+-----+-----+-----+
|  4  | Top  | 407.1/ 426.9| -407.1/ -426.9| 126.6/ 138.8| -126.6/ -138.8|
|      | Base | 409.6/ 429.0| -409.6/ -429.0| 128.1/ 140.1| -128.1/ -140.1|
+-----+-----+-----+-----+
|  3  | Top  | 425.2/ 448.3| -425.2/ -448.3| 137.7/ 151.9| -137.7/ -151.9|
|      | Base | 427.4/ 450.0| -427.4/ -450.0| 139.1/ 153.0| -139.1/ -153.0|
+-----+-----+-----+-----+
|  2  | Top  | 441.4/ 465.3| -441.4/ -465.3| 147.7/ 162.6| -147.7/ -162.6|
|      | Base | 443.3/ 466.7| -443.3/ -466.7| 148.9/ 163.5| -148.9/ -163.5|
+-----+-----+-----+-----+
|  1  | Top  | 455.9/ 477.7| -455.9/ -477.7| 156.7/ 170.7| -156.7/ -170.7|
|      | Base | 458.0/ 479.0| -458.0/ -479.0| 158.0/ 171.6| -158.0/ -171.6|
+-----+-----+-----+-----+

```

SUM OF BEAM DESIGN MOMENT RESISTANCES, MRd,b, AROUND JOINT

```

+-----+
|Storey|Locat.|                Direction of MRd Vector                :                |
|      |      |      +y      |      -y      |      +z      |      -z      |
+-----+-----+-----+-----+-----+-----+
|      |      |      (kNm)   |      (kNm)   |      (kNm)   |      (kNm)   |
+-----+-----+-----+-----+-----+
|  6  | Top  |          241.0|          241.0|          108.3|           59.0|
|      | Base |          281.7|          281.7|          144.7|           87.9|
+-----+-----+-----+-----+
|  5  | Top  |          281.7|          281.7|          144.7|           87.9|

```

	Base	294.4	294.4	140.8	87.9
+-----+					
4	Top	294.4	294.4	140.8	87.9
	Base	294.4	294.4	133.3	87.9
+-----+					
3	Top	294.4	294.4	133.3	87.9
	Base	294.4	294.4	126.8	87.9
+-----+					
2	Top	294.4	294.4	126.8	87.9
	Base	272.6	272.6	108.3	59.0
+-----+					
1	Top	272.6	272.6	108.3	59.0
	Base	0.0	0.0	0.0	0.0
+-----+					

DESIGN OF TRANSVERSE REINFORCEMENT IN SHEAR (for maxN/minN)

Storey	Des. Shear	Provided Ties				strut angle		VR,s		VR,max	
		VEd (kN)		dia. legs spacing-s		(deg)		(middle-kN)		(middle-kN)	
	y z	(mm) y z	middle-mm		y z	y z	y z	y z	y z	y z	
+-----+											
6 maxN	106. 46.	6 3.0 5.0	170		22 22	356. 216.	545. 490.				
minN	106. 44.				22 22	344. 213.	545. 490.				
+-----+											
5 maxN	64. 19.	6 3.0 5.0	170		22 22	397. 230.	545. 490.				
minN	64. 18.				22 22	373. 222.	545. 490.				
+-----+											
4 maxN	67. 17.	6 3.0 5.0	170		22 22	438. 244.	545. 490.				
minN	66. 17.				22 22	402. 232.	545. 490.				
+-----+											
3 maxN	66. 16.	6 3.0 5.0	170		22 22	479. 258.	545. 490.				
minN	66. 16.				22 22	431. 242.	545. 490.				
+-----+											
2 maxN	66. 15.	6 3.0 5.0	170		22 22	519. 271.	545. 490.				
minN	66. 15.				22 22	461. 252.	545. 490.				
+-----+											
1 maxN	194. 63.	6 3.0 5.0	170		22 22	490. 261.	545. 490.				
minN	187. 59.				22 22	442. 245.	545. 490.				
+-----+											

CONFINEMENT REINFORCEMENT AT COLUMN ENDS (for maxN/minN)

Story	Wwd-req.	aWwd-req.	Stirrups			Wwd-prov.	aWwd-prov.
	base top	base top	dia.	legs	spacing-mm	base top	base top
+-----+							

				(mm)	y	z	base	top					
6	0.00	0.00	0.000	0.000	6	3.0	5.0	110	110	0.177	0.177	0.055	0.055
5	0.00	0.00	0.000	0.000	6	3.0	5.0	110	110	0.177	0.177	0.055	0.055
4	0.00	0.00	0.000	0.000	6	3.0	5.0	110	110	0.177	0.177	0.055	0.055
3	0.00	0.00	0.000	0.000	6	3.0	5.0	110	110	0.177	0.177	0.055	0.055
2	0.00	0.00	0.000	0.000	6	3.0	5.0	110	110	0.177	0.177	0.055	0.055
1	0.08	0.00	0.110	0.000	8	3.0	5.0	100	110	0.346	0.315	0.113	0.098

3A 2.4. COLUMN C7

```

*-----*
* COLUMN: 7 *
*-----*
* Concrete: C25 - Long. Reinforcement: S500 - Stirrups: S500 - Cover: 35 (mm) *
*-----*

```

NORMAL STRESS-RESULTANTS

```

*-----*

```

STOREY:	6	Base			Top		
Actions Combination	My	Mz	N	My	Mz	N	
	(kNm)			(kNm)			
EN1990 Eq. 6.10a	-23.7	3.9	527.3	30.1	-4.8	502.0	
EN1990 Eq. 6.10b	-22.5	3.7	499.7	28.6	-4.5	478.1	
G+ψ2Q+E +X +Y/maxN	111.9	105.3	354.2	179.6	122.9	335.4	
G+ψ2Q+E -X +Y/maxN	-143.2	105.3	354.2	-139.9	122.9	335.4	
G+ψ2Q+E +X -Y/maxN	111.9	-100.0	354.2	179.6	-129.2	335.4	
G+ψ2Q+E -X -Y/maxN	-143.2	-100.0	354.2	-139.9	-129.2	335.4	
G+ψ2Q+E +X +Y/minN	111.9	105.3	346.0	179.6	122.9	327.2	
G+ψ2Q+E -X +Y/minN	-143.2	105.3	346.0	-139.9	122.9	327.2	
G+ψ2Q+E +X -Y/minN	111.9	-100.0	346.0	179.6	-129.2	327.2	
G+ψ2Q+E -X -Y/minN	-143.2	-100.0	346.0	-139.9	-129.2	327.2	

```

*-----*

```

STOREY:	5	Base			Top		
Actions Combination	My	Mz	N	My	Mz	N	

	(kNm)	(kNm)	(kN)	(kNm)	(kNm)	(kN)
EN1990 Eq. 6.10a	-19.0	3.4	1021.6	18.4	-3.4	996.3
EN1990 Eq. 6.10b	-18.0	3.3	968.0	17.5	-3.2	946.5
G+ψ2Q+E +X +Y/maxN	113.2	97.2	685.7	139.6	91.2	667.0
G+ψ2Q+E -X +Y/maxN	-138.3	97.2	685.7	-115.2	91.2	667.0
G+ψ2Q+E +X -Y/maxN	113.2	-92.7	685.7	139.6	-95.7	667.0
G+ψ2Q+E -X -Y/maxN	-138.3	-92.7	685.7	-115.2	-95.7	667.0
G+ψ2Q+E +X +Y/minN	113.2	97.2	671.2	139.6	91.2	652.4
G+ψ2Q+E -X +Y/minN	-138.3	97.2	671.2	-115.2	91.2	652.4
G+ψ2Q+E +X -Y/minN	113.2	-92.7	671.2	139.6	-95.7	652.4
G+ψ2Q+E -X -Y/minN	-138.3	-92.7	671.2	-115.2	-95.7	652.4

STOREY: 4	Base			Top		
Actions Combination	My	Mz	N	My	Mz	N
EN1990 Eq. 6.10a	-18.3	3.6	1524.4	18.9	-3.7	1499.1
EN1990 Eq. 6.10b	-17.4	3.4	1444.3	18.0	-3.5	1422.8
G+ψ2Q+E +X +Y/maxN	124.5	101.8	1023.1	150.9	94.9	1004.3
G+ψ2Q+E -X +Y/maxN	-148.6	101.8	1023.1	-125.8	94.9	1004.3
G+ψ2Q+E +X -Y/maxN	124.5	-97.0	1023.1	150.9	-99.8	1004.3
G+ψ2Q+E -X -Y/maxN	-148.6	-97.0	1023.1	-125.8	-99.8	1004.3
G+ψ2Q+E +X +Y/minN	124.5	101.8	1001.6	150.9	94.9	982.9
G+ψ2Q+E -X +Y/minN	-148.6	101.8	1001.6	-125.8	94.9	982.9
G+ψ2Q+E +X -Y/minN	124.5	-97.0	1001.6	150.9	-99.8	982.9
G+ψ2Q+E -X -Y/minN	-148.6	-97.0	1001.6	-125.8	-99.8	982.9

STOREY: 3	Base			Top		
Actions Combination	My	Mz	N	My	Mz	N
EN1990 Eq. 6.10a	-16.3	3.6	2030.4	17.0	-3.8	2005.1
EN1990 Eq. 6.10b	-15.5	3.4	1923.7	16.2	-3.6	1902.2
G+ψ2Q+E +X +Y/maxN	126.9	98.2	1362.7	146.9	85.7	1343.9
G+ψ2Q+E -X +Y/maxN	-148.6	98.2	1362.7	-124.3	85.7	1343.9
G+ψ2Q+E +X -Y/maxN	126.9	-93.4	1362.7	146.9	-90.8	1343.9
G+ψ2Q+E -X -Y/maxN	-148.6	-93.4	1362.7	-124.3	-90.8	1343.9
G+ψ2Q+E +X +Y/minN	126.9	98.2	1334.2	146.9	85.7	1315.4
G+ψ2Q+E -X +Y/minN	-148.6	98.2	1334.2	-124.3	85.7	1315.4
G+ψ2Q+E +X -Y/minN	126.9	-93.4	1334.2	146.9	-90.8	1315.4
G+ψ2Q+E -X -Y/minN	-148.6	-93.4	1334.2	-124.3	-90.8	1315.4

STOREY: 2	Base			Top		
Actions Combination	My	Mz	N	My	Mz	N

	(kNm)	(kNm)	(kN)	(kNm)	(kNm)	(kN)
EN1990 Eq. 6.10a	-14.9	4.6	2540.7	15.3	-4.3	2515.4
EN1990 Eq. 6.10b	-14.1	4.3	2407.2	14.5	-4.1	2385.7
G+ψ2Q+E +X +Y/maxN	130.9	94.4	1704.6	136.3	69.8	1685.9
G+ψ2Q+E -X +Y/maxN	-150.6	94.4	1704.6	-116.1	69.8	1685.9
G+ψ2Q+E +X -Y/maxN	130.9	-88.3	1704.6	136.3	-75.5	1685.9
G+ψ2Q+E -X -Y/maxN	-150.6	-88.3	1704.6	-116.1	-75.5	1685.9
G+ψ2Q+E +X +Y/minN	130.9	94.4	1670.0	136.3	69.8	1651.2
G+ψ2Q+E -X +Y/minN	-150.6	94.4	1670.0	-116.1	69.8	1651.2
G+ψ2Q+E +X -Y/minN	130.9	-88.3	1670.0	136.3	-75.5	1651.2
G+ψ2Q+E -X -Y/minN	-150.6	-88.3	1670.0	-116.1	-75.5	1651.2

STOREY: 1	Base			Top		
Actions Combination	My	Mz	N	My	Mz	N
EN1990 Eq. 6.10a	-9.9	2.8	3074.9	10.5	-3.6	3041.1
EN1990 Eq. 6.10b	-9.4	2.6	2912.6	10.0	-3.4	2883.9
G+ψ2Q+E +X +Y/maxN	103.2	52.7	2063.9	88.9	25.5	2038.9
G+ψ2Q+E -X +Y/maxN	-116.3	52.7	2063.9	-74.9	25.5	2038.9
G+ψ2Q+E +X -Y/maxN	103.2	-49.0	2063.9	88.9	-30.3	2038.9
G+ψ2Q+E -X -Y/maxN	-116.3	-49.0	2063.9	-74.9	-30.3	2038.9
G+ψ2Q+E +X +Y/minN	103.2	52.7	2021.2	88.9	25.5	1996.2
G+ψ2Q+E -X +Y/minN	-116.3	52.7	2021.2	-74.9	25.5	1996.2
G+ψ2Q+E +X -Y/minN	103.2	-49.0	2021.2	88.9	-30.3	1996.2
G+ψ2Q+E -X -Y/minN	-116.3	-49.0	2021.2	-74.9	-30.3	1996.2

STOREY: 0	Base			Top		
Actions Combination	My	Mz	N	My	Mz	N
EN1990 Eq. 6.10a	-7.5	0.8	3579.1	9.9	-2.3	3553.8
EN1990 Eq. 6.10b	-7.2	0.7	3390.3	9.4	-2.1	3368.8
G+ψ2Q+E +X +Y/maxN	6.9	2.8	2396.4	43.3	15.3	2377.6
G+ψ2Q+E -X +Y/maxN	-16.9	2.8	2396.4	-30.3	15.3	2377.6
G+ψ2Q+E +X -Y/maxN	6.9	-1.8	2396.4	43.3	-18.4	2377.6
G+ψ2Q+E -X -Y/maxN	-16.9	-1.8	2396.4	-30.3	-18.4	2377.6
G+ψ2Q+E +X +Y/minN	6.9	2.8	2358.6	43.3	15.3	2339.8
G+ψ2Q+E -X +Y/minN	-16.9	2.8	2358.6	-30.3	15.3	2339.8
G+ψ2Q+E +X -Y/minN	6.9	-1.8	2358.6	43.3	-18.4	2339.8
G+ψ2Q+E -X -Y/minN	-16.9	-1.8	2358.6	-30.3	-18.4	2339.8

STOREY: -1	Base			Top		
Actions Combination	My	Mz	N	My	Mz	N

		(kNm)	(kNm)	(kN)	(kNm)	(kNm)	(kN)		
EN1990 Eq. 6.10a		-1.8	-0.2	4099.8	3.7	0.4	4074.5		
EN1990 Eq. 6.10b		-1.7	-0.2	3883.7	3.5	0.4	3862.1		
G+ψ2Q+E +X +Y/maxN		3.9	6.1	2742.7	8.6	5.8	2724.0		
G+ψ2Q+E -X +Y/maxN		-6.2	6.1	2742.7	-3.7	5.8	2724.0		
G+ψ2Q+E +X -Y/maxN		3.9	-6.4	2742.7	8.6	-5.2	2724.0		
G+ψ2Q+E -X -Y/maxN		-6.2	-6.4	2742.7	-3.7	-5.2	2724.0		
G+ψ2Q+E +X +Y/minN		3.9	6.1	2703.7	8.6	5.8	2684.9		
G+ψ2Q+E -X +Y/minN		-6.2	6.1	2703.7	-3.7	5.8	2684.9		
G+ψ2Q+E +X -Y/minN		3.9	-6.4	2703.7	8.6	-5.2	2684.9		
G+ψ2Q+E -X -Y/minN		-6.2	-6.4	2703.7	-3.7	-5.2	2684.9		
FOR NEGLIGIBLE 2ND-ORDER EFFECTS IN COLUMN, per EC2 pa.5.8.3.1, 5.8.3.2, 5.8.7.2									
Storey	Combination	column direction x				column direction z			
	of actions	slenderness	column	slenderness	column	slenderness	column	slenderness	column
	per EN1990	limit	actual	eff.10	req.size	limit	actual	eff.10	req.size
		(m)				(m)			
6	Eq. 6.10a	130.5	11.0	1.58	0.50	132.3	10.9	1.57	0.50
	Eq. 6.10b	132.0	11.0	1.58	0.50	133.5	10.9	1.57	0.50
5	Eq. 6.10a	94.1	10.9	1.57	0.50	96.7	10.9	1.57	0.50
	Eq. 6.10b	95.2	10.9	1.57	0.50	97.8	10.9	1.57	0.50
4	Eq. 6.10a	83.3	10.9	1.57	0.50	83.7	10.9	1.58	0.50
	Eq. 6.10b	84.5	10.9	1.57	0.50	84.7	10.9	1.57	0.50
3	Eq. 6.10a	72.5	10.9	1.57	0.50	72.2	11.0	1.58	0.50
	Eq. 6.10b	73.5	10.9	1.57	0.50	73.1	11.0	1.58	0.50
2	Eq. 6.10a	65.5	11.0	1.59	0.50	67.5	11.0	1.59	0.50
	Eq. 6.10b	66.5	11.0	1.58	0.50	68.6	11.0	1.59	0.50
1	Eq. 6.10a	59.1	15.3	2.20	0.50	55.2	15.3	2.21	0.50
	Eq. 6.10b	60.0	15.2	2.20	0.50	55.9	15.3	2.21	0.50
0	Eq. 6.10a	51.4	11.0	1.59	0.50	42.2	11.1	1.60	0.50
	Eq. 6.10b	52.2	11.0	1.59	0.50	42.6	11.1	1.60	0.50
-1	Eq. 6.10a	42.6	9.8	1.41	0.50	42.8	9.8	1.41	0.50
	Eq. 6.10b	43.2	9.8	1.41	0.50	43.7	9.7	1.41	0.50

GEOMETRY & LONGITUDINAL REINFORCEMENT

```

+-----+
|Storey 6 Clear height(m):2.50 hcr(m):0.50 X-sect. RECT by(m):0.50 bz(m):0.50|
+-----+
| Vertical steel ratio: 0.0090, Bars: 4Φ18 & 8Φ14 |
|           2Φ18 & 2Φ14 along by 2Φ18 & 2Φ14 along bz |
+-----+
|Storey 5 Clear height(m):2.50 hcr(m):0.50 X-sect. RECT by(m):0.50 bz(m):0.50|
+-----+
| Vertical steel ratio: 0.0090, Bars: 4Φ18 & 8Φ14 |
|           2Φ18 & 2Φ14 along by 2Φ18 & 2Φ14 along bz |
+-----+
|Storey 4 Clear height(m):2.50 hcr(m):0.50 X-sect. RECT by(m):0.50 bz(m):0.50|
+-----+
| Vertical steel ratio: 0.0090, Bars: 4Φ18 & 8Φ14 |
|           2Φ18 & 2Φ14 along by 2Φ18 & 2Φ14 along bz |
+-----+
|Storey 3 Clear height(m):2.50 hcr(m):0.50 X-sect. RECT by(m):0.50 bz(m):0.50|
+-----+
| Vertical steel ratio: 0.0090, Bars: 4Φ18 & 8Φ14 |
|           2Φ18 & 2Φ14 along by 2Φ18 & 2Φ14 along bz |
+-----+
|Storey 2 Clear height(m):2.50 hcr(m):0.50 X-sect. RECT by(m):0.50 bz(m):0.50|
+-----+
| Vertical steel ratio: 0.0090, Bars: 4Φ18 & 8Φ14 |
|           2Φ18 & 2Φ14 along by 2Φ18 & 2Φ14 along bz |
+-----+
|Storey 1 Clear height(m):3.50 hcr(m):0.60 X-sect. RECT by(m):0.50 bz(m):0.50|
+-----+
| Vertical steel ratio: 0.0090, Bars: 4Φ18 & 8Φ14 |
|           2Φ18 & 2Φ14 along by 2Φ18 & 2Φ14 along bz |
+-----+
|Storey 0 Clear height(m):2.50 hcr(m):0.50 X-sect. RECT by(m):0.50 bz(m):0.50|
+-----+
| Vertical steel ratio: 0.0090, Bars: 4Φ18 & 8Φ14 |
|           2Φ18 & 2Φ14 along by 2Φ18 & 2Φ14 along bz |
+-----+
|Storey -1 Clear height(m):2.50 hcr(m):0.50 X-sect. RECT by(m):0.50 bz(m):0.50|
+-----+
| Vertical steel ratio: 0.0090, Bars: 4Φ18 & 8Φ14 |
|           2Φ18 & 2Φ14 along by 2Φ18 & 2Φ14 along bz |
+-----+

```

|Starter bars at base: 4Φ18 & 8Φ14 |
 | 2Φ18 & 2Φ14 along by 2Φ18 & 2Φ14 along bz |

-----+
 COLUMN DESIGN MOMENT RESISTANCE MRd,c (for minN/maxN)
 -----+

Storey	Locat.	Direction of MRd Vector :							
		+y		-y		+z		-z	
		(kNm)		(kNm)		(kNm)		(kNm)	
6	Top	275.6/	277.2	-275.6/	-277.2	275.6/	277.2	-275.6/	-277.2
	Base	279.3/	281.0	-279.3/	-281.0	279.3/	281.0	-279.3/	-281.0
5	Top	355.1/	356.4	-355.1/	-356.4	355.1/	356.4	-355.1/	-356.4
	Base	356.8/	358.2	-356.8/	-358.2	356.8/	358.2	-356.8/	-358.2
4	Top	381.2/	382.6	-381.2/	-382.6	381.2/	382.6	-381.2/	-382.6
	Base	382.4/	383.7	-382.4/	-383.7	382.4/	383.7	-382.4/	-383.7
3	Top	397.5/	398.5	-397.5/	-398.5	397.5/	398.5	-397.5/	-398.5
	Base	398.1/	399.0	-398.1/	-399.0	398.1/	399.0	-398.1/	-399.0
2	Top	403.8/	403.9	-403.8/	-403.9	403.8/	403.9	-403.8/	-403.9
	Base	403.9/	403.9	-403.9/	-403.9	403.9/	403.9	-403.9/	-403.9
1	Top	406.2/	403.4	-406.2/	-403.4	406.2/	403.4	-406.2/	-403.4
	Base	404.6/	401.7	-404.6/	-401.7	404.6/	401.7	-404.6/	-401.7
0	Top	382.9/	380.2	-382.9/	-380.2	382.9/	380.2	-382.9/	-380.2
	Base	381.5/	378.8	-381.5/	-378.8	381.5/	378.8	-381.5/	-378.8
-1	Top	357.1/	354.0	-357.1/	-354.0	357.1/	354.0	-357.1/	-354.0
	Base	355.6/	352.4	-355.6/	-352.4	355.6/	352.4	-355.6/	-352.4

-----+
 SUM OF BEAM DESIGN MOMENT RESISTANCES, MRd,b, AROUND JOINT
 -----+

Storey	Locat.	Direction of MRd Vector :			
		+y		-y	
		(kNm)		(kNm)	
6	Top	218.0		218.0	
	Base	302.0		272.2	
5	Top	302.0		272.2	
	Base	318.3		279.4	

0 maxN		3.	4.	6	4.0	4.0	170	23	23	658.	658.	661.	661.	
minN		3.	4.					23	23	652.	652.	655.	655.	

-1 maxN		0.	4.	6	4.0	4.0	170	25	25	692.	692.	698.	698.	
minN		0.	4.					25	25	686.	686.	692.	692.	

CONFINEMENT REINFORCEMENT AT COLUMN ENDS (for maxN/minN)														

Story	Wwd-req.		aWwd-req.		Stirrups						Wwd-prov.		aWwd-prov.	
	base top		base top		dia.	legs	spacing-mm		base top		base top		base top	
					(mm)	y	z	base top						

6	0.00	0.00	0.000	0.000	6	4.0	4.0	110	110	0.131	0.131	0.078	0.078	

5	0.00	0.00	0.000	0.000	6	4.0	4.0	110	110	0.131	0.131	0.078	0.078	

4	0.00	0.00	0.000	0.000	6	4.0	4.0	110	110	0.131	0.131	0.078	0.078	

3	0.00	0.00	0.000	0.000	6	4.0	4.0	110	110	0.131	0.131	0.078	0.078	

2	0.00	0.00	0.000	0.000	6	4.0	4.0	110	110	0.131	0.131	0.078	0.078	

1	0.08	0.00	0.191	0.000	8	4.0	4.0	85	110	0.302	0.233	0.192	0.139	

0	0.00	0.00	0.000	0.000	6	4.0	4.0	110	110	0.131	0.131	0.078	0.078	

-1	0.00	0.00	0.000	0.000	6	4.0	4.0	110	110	0.131	0.131	0.078	0.078	

3A 2.5. COLUMN C8

* COLUMN: 8														

* Concrete: C25 - Long. Reinforcement: S500 - Stirrups: S500 - Cover: 35 (mm)														

NORMAL STRESS-RESULTANTS														

STOREY:	6		Base						Top					

Actions Combination	My	Mz	N		My	Mz	N	
-----+-----	(kNm)	(kNm)	(kN)		(kNm)	(kNm)	(kN)	
EN1990 Eq. 6.10a	73.5	3.4	341.8		-100.7	-4.1	316.5	
EN1990 Eq. 6.10b	70.0	3.2	323.0		-95.9	-3.9	301.5	
G+ψ2Q+E +X +Y/maxN	113.7	100.1	253.3		23.8	117.4	234.6	
G+ψ2Q+E -X +Y/maxN	-16.6	100.1	253.3		-156.8	117.4	234.6	
G+ψ2Q+E +X -Y/maxN	113.7	-95.5	253.3		23.8	-122.9	234.6	
G+ψ2Q+E -X -Y/maxN	-16.6	-95.5	253.3		-156.8	-122.9	234.6	
G+ψ2Q+E +X +Y/minN	113.7	100.1	202.1		23.8	117.4	183.3	
G+ψ2Q+E -X +Y/minN	-16.6	100.1	202.1		-156.8	117.4	183.3	
G+ψ2Q+E +X -Y/minN	113.7	-95.5	202.1		23.8	-122.9	183.3	
G+ψ2Q+E -X -Y/minN	-16.6	-95.5	202.1		-156.8	-122.9	183.3	

-----+-----
| STOREY: 5 | Base | Top |

Actions Combination	My	Mz	N		My	Mz	N	
-----+-----	(kNm)	(kNm)	(kN)		(kNm)	(kNm)	(kN)	
EN1990 Eq. 6.10a	58.3	3.0	676.0		-53.3	-2.9	650.7	
EN1990 Eq. 6.10b	55.5	2.8	638.7		-50.8	-2.8	617.2	
G+ψ2Q+E +X +Y/maxN	103.9	92.1	516.5		34.1	86.5	497.8	
G+ψ2Q+E -X +Y/maxN	-27.0	92.1	516.5		-104.6	86.5	497.8	
G+ψ2Q+E +X -Y/maxN	103.9	-88.2	516.5		34.1	-90.4	497.8	
G+ψ2Q+E -X -Y/maxN	-27.0	-88.2	516.5		-104.6	-90.4	497.8	
G+ψ2Q+E +X +Y/minN	103.9	92.1	384.2		34.1	86.5	365.4	
G+ψ2Q+E -X +Y/minN	-27.0	92.1	384.2		-104.6	86.5	365.4	
G+ψ2Q+E +X -Y/minN	103.9	-88.2	384.2		34.1	-90.4	365.4	
G+ψ2Q+E -X -Y/minN	-27.0	-88.2	384.2		-104.6	-90.4	365.4	

-----+-----
| STOREY: 4 | Base | Top |

Actions Combination	My	Mz	N		My	Mz	N	
-----+-----	(kNm)	(kNm)	(kN)		(kNm)	(kNm)	(kN)	
EN1990 Eq. 6.10a	60.1	3.2	1010.5		-61.5	-3.2	985.1	
EN1990 Eq. 6.10b	57.3	3.0	954.7		-58.5	-3.0	933.2	
G+ψ2Q+E +X +Y/maxN	112.4	96.3	781.7		34.6	90.0	762.9	
G+ψ2Q+E -X +Y/maxN	-33.0	96.3	781.7		-115.8	90.0	762.9	
G+ψ2Q+E +X -Y/maxN	112.4	-92.0	781.7		34.6	-94.2	762.9	
G+ψ2Q+E -X -Y/maxN	-33.0	-92.0	781.7		-115.8	-94.2	762.9	
G+ψ2Q+E +X +Y/minN	112.4	96.3	564.6		34.6	90.0	545.9	
G+ψ2Q+E -X +Y/minN	-33.0	96.3	564.6		-115.8	90.0	545.9	
G+ψ2Q+E +X -Y/minN	112.4	-92.0	564.6		34.6	-94.2	545.9	
G+ψ2Q+E -X -Y/minN	-33.0	-92.0	564.6		-115.8	-94.2	545.9	

-----+-----
| STOREY: 3 | Base | Top |

Actions Combination	My	Mz	N		My	Mz	N	
-----+-----	(kNm)	(kNm)	(kN)		(kNm)	(kNm)	(kN)	
EN1990 Eq. 6.10a	55.9	-1.2	2334.2		-56.2	1.5	2308.9	
EN1990 Eq. 6.10b	53.2	-1.2	2204.3		-53.6	1.5	2182.8	
G+ψ2Q+E +X +Y/maxN	50.4	1.1	1797.7		7.3	16.5	1779.0	
G+ψ2Q+E -X +Y/maxN	23.4	1.1	1797.7		-81.6	16.5	1779.0	
G+ψ2Q+E +X -Y/maxN	50.4	-2.6	1797.7		7.3	-14.6	1779.0	
G+ψ2Q+E -X -Y/maxN	23.4	-2.6	1797.7		-81.6	-14.6	1779.0	
G+ψ2Q+E +X +Y/minN	50.4	1.1	1313.9		7.3	16.5	1295.1	
G+ψ2Q+E -X +Y/minN	23.4	1.1	1313.9		-81.6	16.5	1295.1	
G+ψ2Q+E +X -Y/minN	50.4	-2.6	1313.9		7.3	-14.6	1295.1	
G+ψ2Q+E -X -Y/minN	23.4	-2.6	1313.9		-81.6	-14.6	1295.1	

STOREY: -1			Base			Top		
Actions Combination	My	Mz	N		My	Mz	N	
-----+-----	(kNm)	(kNm)	(kN)		(kNm)	(kNm)	(kN)	
EN1990 Eq. 6.10a	17.9	-0.3	2647.4		-37.7	0.6	2622.1	
EN1990 Eq. 6.10b	17.1	-0.3	2500.0		-35.9	0.6	2478.5	
G+ψ2Q+E +X +Y/maxN	18.1	5.8	2004.6		-16.0	5.6	1985.9	
G+ψ2Q+E -X +Y/maxN	5.5	5.8	2004.6		-33.7	5.6	1985.9	
G+ψ2Q+E +X -Y/maxN	18.1	-6.2	2004.6		-16.0	-4.8	1985.9	
G+ψ2Q+E -X -Y/maxN	5.5	-6.2	2004.6		-33.7	-4.8	1985.9	
G+ψ2Q+E +X +Y/minN	18.1	5.8	1524.6		-16.0	5.6	1505.9	
G+ψ2Q+E -X +Y/minN	5.5	5.8	1524.6		-33.7	5.6	1505.9	
G+ψ2Q+E +X -Y/minN	18.1	-6.2	1524.6		-16.0	-4.8	1505.9	
G+ψ2Q+E -X -Y/minN	5.5	-6.2	1524.6		-33.7	-4.8	1505.9	

FOR NEGLIGIBLE 2ND-ORDER EFFECTS IN COLUMN, per EC2 pa.5.8.3.1, 5.8.3.2, 5.8.7.2

Storey	Combination	column direction x				column direction z			
	of actions	slenderness	column	slenderness	column	slenderness	column	slenderness	column
	per EN1990	limit	actual	eff.10	req.size	limit	actual	eff.10	req.size
		(m)				(m)			
6	Eq. 6.10a	160.7	11.1	1.60	0.50	166.4	11.0	1.59	0.50
	Eq. 6.10b	162.5	11.1	1.60	0.50	167.9	11.0	1.59	0.50
5	Eq. 6.10a	113.0	11.0	1.59	0.50	118.9	11.0	1.59	0.50
	Eq. 6.10b	114.6	11.0	1.59	0.50	120.4	11.0	1.59	0.50
4	Eq. 6.10a	103.3	11.0	1.59	0.50	103.3	11.0	1.59	0.50
	Eq. 6.10b	104.9	11.0	1.59	0.50	104.7	11.0	1.59	0.50

3	Eq. 6.10a	90.2	11.0	1.59	0.50	87.3	11.1	1.60	0.50	
	Eq. 6.10b	91.6	11.0	1.59	0.50	88.5	11.1	1.60	0.50	
+-----+-----+-----+-----+-----+-----+-----+-----+-----+-----+-----+										
2	Eq. 6.10a	81.0	11.1	1.60	0.50	83.2	11.1	1.60	0.50	
	Eq. 6.10b	82.5	11.1	1.60	0.50	84.8	11.1	1.60	0.50	
+-----+-----+-----+-----+-----+-----+-----+-----+-----+-----+-----+										
1	Eq. 6.10a	74.0	15.6	2.25	0.50	48.0	15.3	2.21	0.50	
	Eq. 6.10b	75.2	15.6	2.24	0.50	48.4	15.3	2.21	0.50	
+-----+-----+-----+-----+-----+-----+-----+-----+-----+-----+-----+										
0	Eq. 6.10a	69.7	11.3	1.64	0.50	64.7	11.0	1.59	0.50	
	Eq. 6.10b	71.0	11.3	1.64	0.50	66.1	11.0	1.59	0.50	
+-----+-----+-----+-----+-----+-----+-----+-----+-----+-----+-----+										
-1	Eq. 6.10a	53.1	9.9	1.43	0.50	53.2	9.7	1.41	0.50	
	Eq. 6.10b	54.0	9.9	1.43	0.50	54.4	9.7	1.41	0.50	
+-----+-----+-----+-----+-----+-----+-----+-----+-----+-----+-----+										

GEOMETRY & LONGITUDINAL REINFORCEMENT

+-----+-----+-----+-----+-----+-----+-----+-----+-----+-----+-----+										
Storey 6	Clear height(m):2.50 hcr(m):0.50 X-sect. RECT by(m):0.50 bz(m):0.50									
+-----+-----+-----+-----+-----+-----+-----+-----+-----+-----+-----+										
Vertical steel ratio:	0.0090, Bars: 4Φ18 & 8Φ14									
	2Φ18 & 2Φ14 along by 2Φ18 & 2Φ14 along bz									
+-----+-----+-----+-----+-----+-----+-----+-----+-----+-----+-----+										
Storey 5	Clear height(m):2.50 hcr(m):0.50 X-sect. RECT by(m):0.50 bz(m):0.50									
+-----+-----+-----+-----+-----+-----+-----+-----+-----+-----+-----+										
Vertical steel ratio:	0.0090, Bars: 4Φ18 & 8Φ14									
	2Φ18 & 2Φ14 along by 2Φ18 & 2Φ14 along bz									
+-----+-----+-----+-----+-----+-----+-----+-----+-----+-----+-----+										
Storey 4	Clear height(m):2.50 hcr(m):0.50 X-sect. RECT by(m):0.50 bz(m):0.50									
+-----+-----+-----+-----+-----+-----+-----+-----+-----+-----+-----+										
Vertical steel ratio:	0.0090, Bars: 4Φ18 & 8Φ14									
	2Φ18 & 2Φ14 along by 2Φ18 & 2Φ14 along bz									
+-----+-----+-----+-----+-----+-----+-----+-----+-----+-----+-----+										
Storey 3	Clear height(m):2.50 hcr(m):0.50 X-sect. RECT by(m):0.50 bz(m):0.50									
+-----+-----+-----+-----+-----+-----+-----+-----+-----+-----+-----+										
Vertical steel ratio:	0.0090, Bars: 4Φ18 & 8Φ14									
	2Φ18 & 2Φ14 along by 2Φ18 & 2Φ14 along bz									
+-----+-----+-----+-----+-----+-----+-----+-----+-----+-----+-----+										
Storey 2	Clear height(m):2.50 hcr(m):0.50 X-sect. RECT by(m):0.50 bz(m):0.50									
+-----+-----+-----+-----+-----+-----+-----+-----+-----+-----+-----+										
Vertical steel ratio:	0.0090, Bars: 4Φ18 & 8Φ14									
	2Φ18 & 2Φ14 along by 2Φ18 & 2Φ14 along bz									
+-----+-----+-----+-----+-----+-----+-----+-----+-----+-----+-----+										

```

|Storey  1 Clear height(m):3.50 hcr(m):0.60 X-sect. RECT by(m):0.50 bz(m):0.50|
+-----+
| Vertical steel ratio: 0.0090, Bars:  4Φ18 &  8Φ14 |
|           2Φ18 &  2Φ14 along by  2Φ18 &  2Φ14 along bz |
+-----+
|Storey  0 Clear height(m):2.50 hcr(m):0.50 X-sect. RECT by(m):0.50 bz(m):0.50|
+-----+
| Vertical steel ratio: 0.0090, Bars:  4Φ18 &  8Φ14 |
|           2Φ18 &  2Φ14 along by  2Φ18 &  2Φ14 along bz |
+-----+
|Storey -1 Clear height(m):2.50 hcr(m):0.50 X-sect. RECT by(m):0.50 bz(m):0.50|
+-----+
| Vertical steel ratio: 0.0090, Bars:  4Φ18 &  8Φ14 |
|           2Φ18 &  2Φ14 along by  2Φ18 &  2Φ14 along bz |
+-----+
|Starter bars at base:  4Φ18 &  8Φ14 |
|           2Φ18 &  2Φ14 along by  2Φ18 &  2Φ14 along bz |
+-----+

```

COLUMN DESIGN MOMENT RESISTANCE MRd,c (for minN/maxN)

Storey	Locat.	Direction of MRd Vector :							
		+y		-y		+z		-z	
		(kNm)		(kNm)		(kNm)		(kNm)	
6	Top	243.9/	255.8	-243.9/	-255.8	243.9/	255.8	-243.9/	-255.8
	Base	248.4/	260.0	-248.4/	-260.0	248.4/	260.0	-248.4/	-260.0
5	Top	283.2/	339.4	-283.2/	-339.4	283.2/	339.4	-283.2/	-339.4
	Base	286.8/	341.4	-286.8/	-341.4	286.8/	341.4	-286.8/	-341.4
4	Top	344.5/	364.9	-344.5/	-364.9	344.5/	364.9	-344.5/	-364.9
	Base	346.5/	366.5	-346.5/	-366.5	346.5/	366.5	-346.5/	-366.5
3	Top	361.6/	384.1	-361.6/	-384.1	361.6/	384.1	-361.6/	-384.1
	Base	363.3/	385.2	-363.3/	-385.2	363.3/	385.2	-363.3/	-385.2
2	Top	375.9/	396.7	-375.9/	-396.7	375.9/	396.7	-375.9/	-396.7
	Base	377.2/	397.4	-377.2/	-397.4	377.2/	397.4	-377.2/	-397.4
1	Top	387.7/	403.0	-387.7/	-403.0	387.7/	403.0	-387.7/	-403.0
	Base	389.0/	403.3	-389.0/	-403.3	389.0/	403.3	-389.0/	-403.3
0	Top	396.8/	403.5	-396.8/	-403.5	396.8/	403.5	-396.8/	-403.5
	Base								

	Base	397.5/ 403.3	-397.5/ -403.3	397.5/ 403.3	-397.5/ -403.3
-1	Top	402.3/ 406.9	-402.3/ -406.9	402.3/ 406.9	-402.3/ -406.9
	Base	402.6/ 405.7	-402.6/ -405.7	402.6/ 405.7	-402.6/ -405.7

SUM OF BEAM DESIGN MOMENT RESISTANCES, MRd,b, AROUND JOINT

Storey	Locat.	Direction of MRd Vector :			
		+y	-y	+z	-z
		(kNm)	(kNm)	(kNm)	(kNm)
6	Top	87.7	154.4	235.9	235.9
	Base	173.6	230.4	249.4	249.4
5	Top	173.6	230.4	249.4	249.4
	Base	173.6	230.4	249.4	249.4
4	Top	173.6	230.4	249.4	249.4
	Base	173.6	230.4	249.4	249.4
3	Top	173.6	230.4	249.4	249.4
	Base	173.6	230.4	242.2	242.2
2	Top	173.6	230.4	242.2	242.2
	Base	117.2	203.3	242.2	242.2
1	Top	117.2	203.3	242.2	242.2
	Base	30.3	101.4	158.7	158.7
0	Top	30.3	101.4	158.7	158.7
	Base	30.3	90.7	164.7	164.7
-1	Top	30.3	90.7	164.7	164.7
	Base	0.0	0.0	0.0	0.0

DESIGN OF TRANSVERSE REINFORCEMENT IN SHEAR (for maxN/minN)

Storey	Des. Shear	Provided Ties		strut angle		VR,s		VR,max					
		dia.	legs	spacing-s	(deg)	(middle-kN)	(middle-kN)	(middle-kN)	(middle-kN)				
		y	z	middle-mm	y	z	y	z	y	z			
6	maxN	68.	104.	6	4.0	4.0	170	22	22	334.	334.	629.	629.
	minN	68.	104.					22	22	323.	323.	629.	629.

+-----+																			
	5	maxN	58.	63.		6	4.0	4.0		170		22	22	376.	376.		629.	629.	
		minN	54.	59.								22	22	352.	352.		629.	629.	
+-----+																			
	4	maxN	53.	57.		6	4.0	4.0		170		22	22	419.	419.		629.	629.	
		minN	56.	60.								22	22	381.	381.		629.	629.	
+-----+																			
	3	maxN	52.	56.		6	4.0	4.0		170		22	22	461.	461.		629.	629.	
		minN	52.	56.								22	22	409.	409.		629.	629.	
+-----+																			
	2	maxN	52.	54.		6	4.0	4.0		170		22	22	504.	504.		629.	629.	
		minN	52.	54.								22	22	438.	438.		629.	629.	
+-----+																			
	1	maxN	32.	38.		6	4.0	4.0		170		22	22	474.	474.		629.	629.	
		minN	32.	39.								22	22	418.	418.		629.	629.	
+-----+																			
	0	maxN	17.	4.		6	4.0	4.0		170		22	22	582.	582.		629.	629.	
		minN	17.	4.								22	22	501.	501.		629.	629.	
+-----+																			
	-1	maxN	7.	4.		6	4.0	4.0		170		22	22	615.	615.		629.	629.	
		minN	7.	4.								22	22	535.	535.		629.	629.	
+-----+																			
CONFINEMENT REINFORCEMENT AT COLUMN ENDS (for maxN/minN)																			
+-----+																			
	Story	Wwd-req.		aWwd-req.						Stirrups		Wwd-prov.		aWwd-prov.					
			base top		base top		dia.	legs	spacing-mm		base top		base top						
							(mm)	y	z	base top									
+-----+																			
	6		0.00	0.00	0.000	0.000	6	4.0	4.0	110	110	0.131	0.131	0.078	0.078				
+-----+																			
	5		0.00	0.00	0.000	0.000	6	4.0	4.0	110	110	0.131	0.131	0.078	0.078				
+-----+																			
	4		0.00	0.00	0.000	0.000	6	4.0	4.0	110	110	0.131	0.131	0.078	0.078				
+-----+																			
	3		0.00	0.00	0.000	0.000	6	4.0	4.0	110	110	0.131	0.131	0.078	0.078				
+-----+																			
	2		0.00	0.00	0.000	0.000	6	4.0	4.0	110	110	0.131	0.131	0.078	0.078				
+-----+																			
	1		0.08	0.00	0.138	0.000	8	4.0	4.0	110	110	0.233	0.233	0.139	0.139				
+-----+																			
	0		0.00	0.00	0.000	0.000	6	4.0	4.0	110	110	0.131	0.131	0.078	0.078				
+-----+																			

```
| -1 | 0.00 0.00|0.000 0.000| 6  4.0  4.0  110  110| 0.131 0.131| 0.078 0.078|
+-----+
```

3A 2.6. COLUMN C11

```
*-----*
* COLUMN: 11 *
*-----*
* Concrete: C25 - Long. Reinforcement: S500 - Stirrups: S500 - Cover: 35 (mm) *
*-----*
```

NORMAL STRESS-RESULTANTS

```
*-----*
```

STOREY: 6	Base			Top		
Actions Combination	My	Mz	N	My	Mz	N
	(kNm)	(kNm)	(kN)	(kNm)	(kNm)	(kN)
EN1990 Eq. 6.10a	-33.0	-21.9	121.1	40.1	31.7	99.8
EN1990 Eq. 6.10b	-31.4	-20.8	113.1	38.2	30.1	95.0
G+ψ2Q+E +X +Y/maxN	27.4	99.8	156.1	85.0	190.2	140.3
G+ψ2Q+E -X +Y/maxN	-71.1	99.8	156.1	-31.9	190.2	140.3
G+ψ2Q+E +X -Y/maxN	27.4	-128.8	156.1	85.0	-148.2	140.3
G+ψ2Q+E -X -Y/maxN	-71.1	-128.8	156.1	-31.9	-148.2	140.3
G+ψ2Q+E +X +Y/minN	27.4	99.8	7.3	85.0	190.2	-8.5
G+ψ2Q+E -X +Y/minN	-71.1	99.8	7.3	-31.9	190.2	-8.5
G+ψ2Q+E +X -Y/minN	27.4	-128.8	7.3	85.0	-148.2	-8.5
G+ψ2Q+E -X -Y/minN	-71.1	-128.8	7.3	-31.9	-148.2	-8.5

```
+-----+
```

```
*-----*
```

STOREY: 5	Base			Top		
Actions Combination	My	Mz	N	My	Mz	N
	(kNm)	(kNm)	(kN)	(kNm)	(kNm)	(kN)
EN1990 Eq. 6.10a	-27.9	-17.6	248.9	27.0	15.4	227.6
EN1990 Eq. 6.10b	-26.5	-16.8	232.6	25.7	14.7	214.5
G+ψ2Q+E +X +Y/maxN	30.1	87.6	331.8	66.7	103.0	316.0
G+ψ2Q+E -X +Y/maxN	-67.0	87.6	331.8	-31.0	103.0	316.0
G+ψ2Q+E +X -Y/maxN	30.1	-111.0	331.8	66.7	-82.6	316.0
G+ψ2Q+E -X -Y/maxN	-67.0	-111.0	331.8	-31.0	-82.6	316.0
G+ψ2Q+E +X +Y/minN	30.1	87.6	3.8	66.7	103.0	-11.9
G+ψ2Q+E -X +Y/minN	-67.0	87.6	3.8	-31.0	103.0	-11.9
G+ψ2Q+E +X -Y/minN	30.1	-111.0	3.8	66.7	-82.6	-11.9
G+ψ2Q+E -X -Y/minN	-67.0	-111.0	3.8	-31.0	-82.6	-11.9

```
+-----+
```

STOREY: 4		Base			Top		
Actions Combination	My	Mz	N	My	Mz	N	
	(kNm)	(kNm)	(kN)	(kNm)	(kNm)	(kN)	
EN1990 Eq. 6.10a	-28.0	-19.1	375.5	28.4	19.1	354.2	
EN1990 Eq. 6.10b	-26.6	-18.2	351.0	27.0	18.1	332.9	
G+ψ2Q+E +X +Y/maxN	33.3	96.3	507.9	70.8	119.1	492.2	
G+ψ2Q+E -X +Y/maxN	-70.3	96.3	507.9	-33.3	119.1	492.2	
G+ψ2Q+E +X -Y/maxN	33.3	-121.6	507.9	70.8	-93.9	492.2	
G+ψ2Q+E -X -Y/maxN	-70.3	-121.6	507.9	-33.3	-93.9	492.2	
G+ψ2Q+E +X +Y/minN	33.3	96.3	-1.6	70.8	119.1	-17.4	
G+ψ2Q+E -X +Y/minN	-70.3	96.3	-1.6	-33.3	119.1	-17.4	
G+ψ2Q+E +X -Y/minN	33.3	-121.6	-1.6	70.8	-93.9	-17.4	
G+ψ2Q+E -X -Y/minN	-70.3	-121.6	-1.6	-33.3	-93.9	-17.4	
+-----+							
STOREY: 3		Base			Top		
Actions Combination	My	Mz	N	My	Mz	N	
	(kNm)	(kNm)	(kN)	(kNm)	(kNm)	(kN)	
EN1990 Eq. 6.10a	-26.5	-18.4	502.0	27.1	18.5	480.8	
EN1990 Eq. 6.10b	-25.3	-17.5	469.2	25.8	17.6	451.1	
G+ψ2Q+E +X +Y/maxN	34.3	96.7	683.0	69.0	104.9	667.3	
G+ψ2Q+E -X +Y/maxN	-69.4	96.7	683.0	-33.1	104.9	667.3	
G+ψ2Q+E +X -Y/maxN	34.3	-121.1	683.0	69.0	-80.4	667.3	
G+ψ2Q+E -X -Y/maxN	-69.4	-121.1	683.0	-33.1	-80.4	667.3	
G+ψ2Q+E +X +Y/minN	34.3	96.7	-6.2	69.0	104.9	-21.9	
G+ψ2Q+E -X +Y/minN	-69.4	96.7	-6.2	-33.1	104.9	-21.9	
G+ψ2Q+E +X -Y/minN	34.3	-121.1	-6.2	69.0	-80.4	-21.9	
G+ψ2Q+E -X -Y/minN	-69.4	-121.1	-6.2	-33.1	-80.4	-21.9	
+-----+							
STOREY: 2		Base			Top		
Actions Combination	My	Mz	N	My	Mz	N	
	(kNm)	(kNm)	(kN)	(kNm)	(kNm)	(kN)	
EN1990 Eq. 6.10a	-28.7	-24.2	628.5	27.3	20.5	607.2	
EN1990 Eq. 6.10b	-27.3	-23.0	587.4	26.0	19.5	569.4	
G+ψ2Q+E +X +Y/maxN	32.1	85.2	849.7	65.4	84.2	833.9	
G+ψ2Q+E -X +Y/maxN	-70.0	85.2	849.7	-29.2	84.2	833.9	
G+ψ2Q+E +X -Y/maxN	32.1	-117.2	849.7	65.4	-57.1	833.9	
G+ψ2Q+E -X -Y/maxN	-70.0	-117.2	849.7	-29.2	-57.1	833.9	
G+ψ2Q+E +X +Y/minN	32.1	85.2	-2.3	65.4	84.2	-18.1	
G+ψ2Q+E -X +Y/minN	-70.0	85.2	-2.3	-29.2	84.2	-18.1	
G+ψ2Q+E +X -Y/minN	32.1	-117.2	-2.3	65.4	-57.1	-18.1	
G+ψ2Q+E -X -Y/minN	-70.0	-117.2	-2.3	-29.2	-57.1	-18.1	
+-----+							

STOREY: 1	Base			Top		
Actions Combination	My	Mz	N	My	Mz	N
	(kNm)	(kNm)	(kN)	(kNm)	(kNm)	(kN)
EN1990 Eq. 6.10a	-12.5	-7.5	759.9	17.7	14.3	731.5
EN1990 Eq. 6.10b	-11.9	-7.2	709.6	16.8	13.6	685.5
G+ψ2Q+E +X +Y/maxN	33.7	103.8	1001.8	43.6	44.3	980.8
G+ψ2Q+E -X +Y/maxN	-50.2	103.8	1001.8	-20.3	44.3	980.8
G+ψ2Q+E +X -Y/maxN	33.7	-113.8	1001.8	43.6	-25.4	980.8
G+ψ2Q+E -X -Y/maxN	-50.2	-113.8	1001.8	-20.3	-25.4	980.8
G+ψ2Q+E +X +Y/minN	33.7	103.8	23.6	43.6	44.3	2.6
G+ψ2Q+E -X +Y/minN	-50.2	103.8	23.6	-20.3	44.3	2.6
G+ψ2Q+E +X -Y/minN	33.7	-113.8	23.6	43.6	-25.4	2.6
G+ψ2Q+E -X -Y/minN	-50.2	-113.8	23.6	-20.3	-25.4	2.6

FOR NEGLIGIBLE 2ND-ORDER EFFECTS IN COLUMN, per EC2 pa.5.8.3.1, 5.8.3.2, 5.8.7.2

Storey	Combination	column direction x				column direction z			
	of actions	slenderness	column	slenderness	column	slenderness	column	slenderness	column
	per EN1990	limit	actual	eff.10	req.size	limit	actual	eff.10	req.size
		(m)				(m)			
6	Eq. 6.10a	270.9	17.4	1.50	0.30	256.6	8.0	1.61	0.70
	Eq. 6.10b	273.9	17.4	1.50	0.30	259.4	8.0	1.61	0.70
5	Eq. 6.10a	176.4	17.1	1.48	0.30	167.7	8.0	1.61	0.70
	Eq. 6.10b	179.8	17.1	1.48	0.30	170.8	8.0	1.61	0.70
4	Eq. 6.10a	157.6	17.2	1.49	0.30	156.6	8.0	1.61	0.70
	Eq. 6.10b	160.6	17.2	1.49	0.30	160.1	8.0	1.61	0.70
3	Eq. 6.10a	136.1	17.2	1.49	0.30	137.0	8.0	1.62	0.70
	Eq. 6.10b	138.8	17.2	1.49	0.30	139.6	8.0	1.62	0.70
2	Eq. 6.10a	120.8	17.4	1.51	0.30	120.6	8.1	1.63	0.70
	Eq. 6.10b	123.6	17.4	1.51	0.30	123.6	8.1	1.63	0.70
1	Eq. 6.10a	100.4	24.2	2.10	0.30	93.0	11.2	2.26	0.70
	Eq. 6.10b	102.5	24.2	2.09	0.30	94.9	11.2	2.26	0.70

GEOMETRY & LONGITUDINAL REINFORCEMENT

Storey 6 Clear height (m):2.50 hcr (m):0.70 X-sect. RECT by (m):0.70 bz (m):0.30

```

| Vertical steel ratio: 0.0097, Bars: 4Φ16 & 8Φ14 |
|           2Φ16 & 3Φ14 along by 2Φ16 & 1Φ14 along bz |
+-----+
|Storey 5 Clear height(m):2.50 hcr(m):0.70 X-sect. RECT by(m):0.70 bz(m):0.30|
+-----+
| Vertical steel ratio: 0.0097, Bars: 4Φ16 & 8Φ14 |
|           2Φ16 & 3Φ14 along by 2Φ16 & 1Φ14 along bz |
+-----+
|Storey 4 Clear height(m):2.50 hcr(m):0.70 X-sect. RECT by(m):0.70 bz(m):0.30|
+-----+
| Vertical steel ratio: 0.0097, Bars: 4Φ16 & 8Φ14 |
|           2Φ16 & 3Φ14 along by 2Φ16 & 1Φ14 along bz |
+-----+
|Storey 3 Clear height(m):2.50 hcr(m):0.70 X-sect. RECT by(m):0.70 bz(m):0.30|
+-----+
| Vertical steel ratio: 0.0097, Bars: 4Φ16 & 8Φ14 |
|           2Φ16 & 3Φ14 along by 2Φ16 & 1Φ14 along bz |
+-----+
|Storey 2 Clear height(m):2.50 hcr(m):0.70 X-sect. RECT by(m):0.70 bz(m):0.30|
+-----+
| Vertical steel ratio: 0.0097, Bars: 4Φ16 & 8Φ14 |
|           2Φ16 & 3Φ14 along by 2Φ16 & 1Φ14 along bz |
+-----+
|Storey 1 Clear height(m):3.50 hcr(m):0.70 X-sect. RECT by(m):0.70 bz(m):0.30|
+-----+
| Vertical steel ratio: 0.0097, Bars: 4Φ16 & 8Φ14 |
|           2Φ16 & 3Φ14 along by 2Φ16 & 1Φ14 along bz |
+-----+
|Starter bars at base: 4Φ16 & 8Φ14 |
|           2Φ16 & 3Φ14 along by 2Φ16 & 1Φ14 along bz |
+-----+

```

COLUMN DESIGN MOMENT RESISTANCE MRd,c (for minN/maxN)

```

+-----+
|Storey|Locat.|          Direction of MRd Vector          : |
|      |      |      +y      |      -y      |      +z      |      -z      |
+-----+-----+-----+-----+-----+-----+
|      |      |      (kNm)  |      (kNm)  |      (kNm)  |      (kNm)  |
+-----+-----+-----+-----+-----+-----+
|  6  | Top  |  84.1/ 103.5| -84.1/ -103.5|  340.9/  370.5| -340.9/ -370.5|
|      | Base |  86.3/ 105.4| -86.3/ -105.4|  344.2/  373.4| -344.2/ -373.4|
+-----+-----+-----+-----+-----+-----+
|  5  | Top  |  83.6/ 123.0| -83.6/ -123.0|  340.2/  401.3| -340.2/ -401.3|
|      | Base |  85.8/ 124.6| -85.8/ -124.6|  343.4/  403.8| -343.4/ -403.8|
+-----+-----+-----+-----+-----+-----+

```

4	Top	82.8/ 139.3	-82.8/ -139.3	339.0/ 427.7	-339.0/ -427.7
	Base	85.0/ 140.6	-85.0/ -140.6	342.3/ 429.9	-342.3/ -429.9
+-----+					
3	Top	82.2/ 152.7	-82.2/ -152.7	255.8/ 449.6	-255.8/ -449.6
	Base	84.4/ 153.8	-84.4/ -153.8	341.4/ 451.3	-341.4/ -451.3
+-----+					
2	Top	82.7/ 163.2	-82.7/ -163.2	338.9/ 466.2	-338.9/ -466.2
	Base	84.9/ 164.1	-84.9/ -164.1	342.2/ 467.6	-342.2/ -467.6
+-----+					
1	Top	85.6/ 170.6	-85.6/ -170.6	343.2/ 477.6	-343.2/ -477.6
	Base	88.5/ 171.6	-88.5/ -171.6	347.5/ 479.0	-347.5/ -479.0
+-----+					

SUM OF BEAM DESIGN MOMENT RESISTANCES, MRd,b, AROUND JOINT

Storey	Locat.	Direction of MRd Vector :			
		+y	-y	+z	-z
		(kNm)	(kNm)	(kNm)	(kNm)
6	Top	83.4	58.5	170.8	188.3
	Base	134.6	86.9	223.2	232.7
+-----+					
5	Top	134.6	86.9	223.2	232.7
	Base	134.6	86.9	223.2	232.7
+-----+					
4	Top	134.6	86.9	223.2	232.7
	Base	134.6	86.9	170.8	236.2
+-----+					
3	Top	134.6	86.9	170.8	236.2
	Base	134.6	86.9	170.8	204.1
+-----+					
2	Top	134.6	86.9	170.8	204.1
	Base	109.6	58.5	116.0	158.0
+-----+					
1	Top	109.6	58.5	116.0	158.0
	Base	0.0	0.0	0.0	0.0
+-----+					

DESIGN OF TRANSVERSE REINFORCEMENT IN SHEAR (for maxN/minN)

Storey	Des. Shear	Provided Ties		strut angle	VR,s		VR,max	
		dia.	legs		(middle-kN)	(middle-kN)		
		y	z	(deg)	y	z	y	z
		(mm)	middle-mm					
6 maxN	37. 83.	6	5.0 3.0	170	22	22	216. 355.	490. 545.

minN	37.	83.		22	22	203.	315.		490.	545.						
+-----+																
5 maxN	32.	78.		6	5.0	3.0	170		22	22	230.	397.		490.	545.	
minN	30.	76.		22	22	203.	315.		490.	545.						
+-----+																
4 maxN	31.	77.		6	5.0	3.0	170		22	22	245.	440.		490.	545.	
minN	29.	76.		22	22	202.	313.		490.	545.						
+-----+																
3 maxN	31.	78.		6	5.0	3.0	170		22	22	259.	482.		490.	545.	
minN	29.	71.		22	22	202.	312.		490.	545.						
+-----+																
2 maxN	31.	67.		6	5.0	3.0	170		22	22	272.	522.		490.	545.	
minN	30.	71.		22	22	202.	313.		490.	545.						
+-----+																
1 maxN	72.	188.		6	5.0	3.0	170		22	22	261.	490.		490.	545.	
minN	45.	146.		22	22	204.	318.		490.	545.						
+-----+																

CONFINEMENT REINFORCEMENT AT COLUMN ENDS (for maxN/minN)

Story	Wwd-req.		aWwd-req.		Stirrups					Wwd-prov.		aWwd-prov.	
	base	top	base	top	dia.	legs	spacing-mm	base	top	base	top		
					(mm)	y	z	base	top				
6	0.00	0.00	0.000	0.000	6	5.0	3.0	110	110	0.177	0.177	0.055	0.055
5	0.00	0.00	0.000	0.000	6	5.0	3.0	110	110	0.177	0.177	0.055	0.055
4	0.00	0.00	0.000	0.000	6	5.0	3.0	110	110	0.177	0.177	0.055	0.055
3	0.00	0.00	0.000	0.000	6	5.0	3.0	110	110	0.177	0.177	0.055	0.055
2	0.00	0.00	0.000	0.000	6	5.0	3.0	110	110	0.177	0.177	0.055	0.055
1	0.08	0.00	0.092	0.000	6	5.0	3.0	75	110	0.260	0.177	0.097	0.055

3A 2.7. COLUMN C12

* COLUMN: 12 *

 * Concrete: C25 - Long. Reinforcement: S500 - Stirrups: S500 - Cover: 35 (mm) *

NORMAL STRESS-RESULTANTS

STOREY: 6	Base			Top		
Actions Combination	My	Mz	N	My	Mz	N
	(kNm)	(kNm)	(kN)	(kNm)	(kNm)	(kN)
EN1990 Eq. 6.10a	-5.2	-74.1	255.3	3.7	88.9	234.1
EN1990 Eq. 6.10b	-4.9	-70.6	241.0	3.4	84.7	223.0
G+ψ2Q+E +X +Y/maxN	112.9	-2.1	189.3	163.1	113.2	173.5
G+ψ2Q+E -X +Y/maxN	-119.8	-2.1	189.3	-158.2	113.2	173.5
G+ψ2Q+E +X -Y/maxN	112.9	-95.7	189.3	163.1	4.2	173.5
G+ψ2Q+E -X -Y/maxN	-119.8	-95.7	189.3	-158.2	4.2	173.5
G+ψ2Q+E +X +Y/minN	112.9	-2.1	151.3	163.1	113.2	135.5
G+ψ2Q+E -X +Y/minN	-119.8	-2.1	151.3	-158.2	113.2	135.5
G+ψ2Q+E +X -Y/minN	112.9	-95.7	151.3	163.1	4.2	135.5
G+ψ2Q+E -X -Y/minN	-119.8	-95.7	151.3	-158.2	4.2	135.5

+-----+

STOREY: 5	Base			Top		
Actions Combination	My	Mz	N	My	Mz	N
	(kNm)	(kNm)	(kN)	(kNm)	(kNm)	(kN)
EN1990 Eq. 6.10a	-5.2	-63.4	515.0	5.9	61.6	493.8
EN1990 Eq. 6.10b	-4.9	-60.4	486.2	5.6	58.6	468.1
G+ψ2Q+E +X +Y/maxN	111.3	1.8	391.2	123.3	83.9	375.5
G+ψ2Q+E -X +Y/maxN	-118.2	1.8	391.2	-115.5	83.9	375.5
G+ψ2Q+E +X -Y/maxN	111.3	-85.5	391.2	123.3	-2.6	375.5
G+ψ2Q+E -X -Y/maxN	-118.2	-85.5	391.2	-115.5	-2.6	375.5
G+ψ2Q+E +X +Y/minN	111.3	1.8	295.6	123.3	83.9	279.9
G+ψ2Q+E -X +Y/minN	-118.2	1.8	295.6	-115.5	83.9	279.9
G+ψ2Q+E +X -Y/minN	111.3	-85.5	295.6	123.3	-2.6	279.9
G+ψ2Q+E -X -Y/minN	-118.2	-85.5	295.6	-115.5	-2.6	279.9

+-----+

STOREY: 4	Base			Top		
Actions Combination	My	Mz	N	My	Mz	N
	(kNm)	(kNm)	(kN)	(kNm)	(kNm)	(kN)
EN1990 Eq. 6.10a	-4.4	-64.2	774.3	4.5	64.6	753.1
EN1990 Eq. 6.10b	-4.2	-61.1	731.0	4.3	61.6	712.9
G+ψ2Q+E +X +Y/maxN	122.9	2.5	592.4	131.8	87.1	576.6
G+ψ2Q+E -X +Y/maxN	-128.8	2.5	592.4	-125.8	87.1	576.6
G+ψ2Q+E +X -Y/maxN	122.9	-87.3	592.4	131.8	-1.7	576.6
G+ψ2Q+E -X -Y/maxN	-128.8	-87.3	592.4	-125.8	-1.7	576.6

G+ψ2Q+E +X +Y/minN	122.9	2.5	440.3		131.8	87.1	424.5	
G+ψ2Q+E -X +Y/minN	-128.8	2.5	440.3		-125.8	87.1	424.5	
G+ψ2Q+E +X -Y/minN	122.9	-87.3	440.3		131.8	-1.7	424.5	
G+ψ2Q+E -X -Y/minN	-128.8	-87.3	440.3		-125.8	-1.7	424.5	

+-----+							
	STOREY:	3		Base		Top	
Actions Combination				My	Mz	N	
				My	Mz	N	
				(kNm)	(kNm)	(kN)	
EN1990 Eq. 6.10a				-4.3	-61.7	1033.9	
EN1990 Eq. 6.10b				-4.0	-58.7	976.0	
G+ψ2Q+E +X +Y/maxN				127.6	2.1	792.9	
G+ψ2Q+E -X +Y/maxN				-133.3	2.1	792.9	
G+ψ2Q+E +X -Y/maxN				127.6	-83.5	792.9	
G+ψ2Q+E -X -Y/maxN				-133.3	-83.5	792.9	
G+ψ2Q+E +X +Y/minN				127.6	2.1	585.8	
G+ψ2Q+E -X +Y/minN				-133.3	2.1	585.8	
G+ψ2Q+E +X -Y/minN				127.6	-83.5	585.8	
G+ψ2Q+E -X -Y/minN				-133.3	-83.5	585.8	

+-----+							
	STOREY:	2		Base		Top	
Actions Combination				My	Mz	N	
				My	Mz	N	
				(kNm)	(kNm)	(kN)	
EN1990 Eq. 6.10a				-2.1	-69.7	1293.9	
EN1990 Eq. 6.10b				-1.9	-66.4	1221.6	
G+ψ2Q+E +X +Y/maxN				127.1	-7.2	990.8	
G+ψ2Q+E -X +Y/maxN				-129.9	-7.2	990.8	
G+ψ2Q+E +X -Y/maxN				127.1	-84.8	990.8	
G+ψ2Q+E -X -Y/maxN				-129.9	-84.8	990.8	
G+ψ2Q+E +X +Y/minN				127.1	-7.2	734.7	
G+ψ2Q+E -X +Y/minN				-129.9	-7.2	734.7	
G+ψ2Q+E +X -Y/minN				127.1	-84.8	734.7	
G+ψ2Q+E -X -Y/minN				-129.9	-84.8	734.7	

+-----+							
	STOREY:	1		Base		Top	
Actions Combination				My	Mz	N	
				My	Mz	N	
				(kNm)	(kNm)	(kN)	
EN1990 Eq. 6.10a				-3.6	-19.0	1559.4	
EN1990 Eq. 6.10b				-3.4	-18.0	1471.5	
G+ψ2Q+E +X +Y/maxN				146.7	9.3	1185.8	
G+ψ2Q+E -X +Y/maxN				-151.5	9.3	1185.8	
G+ψ2Q+E +X -Y/maxN				146.7	-34.4	1185.8	
G+ψ2Q+E -X -Y/maxN				-151.5	-34.4	1185.8	

G+ψ2Q+E +X +Y/minN	146.7	9.3	894.7		80.1	40.1	873.7	
G+ψ2Q+E -X +Y/minN	-151.5	9.3	894.7		-77.2	40.1	873.7	
G+ψ2Q+E +X -Y/minN	146.7	-34.4	894.7		80.1	9.6	873.7	
G+ψ2Q+E -X -Y/minN	-151.5	-34.4	894.7		-77.2	9.6	873.7	

-----+							
	STOREY:	0		Base		Top	
Actions Combination				My	Mz	N	
				My	Mz	N	
				(kNm)	(kNm)	(kN)	
EN1990 Eq. 6.10a				-2.9	-2.6	2084.8	
EN1990 Eq. 6.10b				-2.8	-2.5	1969.1	
G+ψ2Q+E +X +Y/maxN				19.2	1.2	1537.6	
G+ψ2Q+E -X +Y/maxN				-23.2	1.2	1537.6	
G+ψ2Q+E +X -Y/maxN				19.2	-4.8	1537.6	
G+ψ2Q+E -X -Y/maxN				-23.2	-4.8	1537.6	
G+ψ2Q+E +X +Y/minN				19.2	1.2	1241.2	
G+ψ2Q+E -X +Y/minN				-23.2	1.2	1241.2	
G+ψ2Q+E +X -Y/minN				19.2	-4.8	1241.2	
G+ψ2Q+E -X -Y/minN				-23.2	-4.8	1241.2	

-----+							
	STOREY:	-1		Base		Top	
Actions Combination				My	Mz	N	
				My	Mz	N	
				(kNm)	(kNm)	(kN)	
EN1990 Eq. 6.10a				-0.2	-1.1	2613.3	
EN1990 Eq. 6.10b				-0.1	-1.0	2469.6	
G+ψ2Q+E +X +Y/maxN				11.2	3.2	1887.4	
G+ψ2Q+E -X +Y/maxN				-11.5	3.2	1887.4	
G+ψ2Q+E +X -Y/maxN				11.2	-4.7	1887.4	
G+ψ2Q+E -X -Y/maxN				-11.5	-4.7	1887.4	
G+ψ2Q+E +X +Y/minN				11.2	3.2	1593.6	
G+ψ2Q+E -X +Y/minN				-11.5	3.2	1593.6	
G+ψ2Q+E +X -Y/minN				11.2	-4.7	1593.6	
G+ψ2Q+E -X -Y/minN				-11.5	-4.7	1593.6	

FOR NEGLIGIBLE 2ND-ORDER EFFECTS IN COLUMN, per EC2 pa.5.8.3.1, 5.8.3.2, 5.8.7.2

-----+										
Storey	Combination	column direction x				column direction z				
	of actions	slenderness	column	slenderness	column	slenderness	column	slenderness	column	
	per EN1990	limit	actual	eff.10	req.size	limit	actual	eff.10	req.size	
----- (m) -----										
6	Eq. 6.10a	161.0	8.0	1.62	0.70	177.6	17.3	1.50	0.30	
	Eq. 6.10b	162.9	8.0	1.62	0.70	179.6	17.3	1.50	0.30	

5	Eq. 6.10a	126.5	8.0	1.61	0.70	123.2	17.1	1.48	0.30
	Eq. 6.10b	128.1	8.0	1.61	0.70	125.0	17.1	1.48	0.30
+-----+-----+-----+-----+-----+-----+-----+-----+-----+-----+									
4	Eq. 6.10a	107.6	8.0	1.61	0.70	108.4	17.2	1.49	0.30
	Eq. 6.10b	109.0	8.0	1.61	0.70	110.0	17.2	1.49	0.30
+-----+-----+-----+-----+-----+-----+-----+-----+-----+-----+									
3	Eq. 6.10a	94.0	8.0	1.61	0.70	94.0	17.4	1.51	0.30
	Eq. 6.10b	95.3	8.0	1.61	0.70	95.5	17.4	1.51	0.30
+-----+-----+-----+-----+-----+-----+-----+-----+-----+-----+									
2	Eq. 6.10a	73.4	8.0	1.62	0.70	84.4	17.7	1.53	0.30
	Eq. 6.10b	74.2	8.0	1.62	0.70	86.0	17.7	1.53	0.30
+-----+-----+-----+-----+-----+-----+-----+-----+-----+-----+									
1	Eq. 6.10a	72.6	11.1	2.24	0.70	63.6	23.9	2.07	0.30
	Eq. 6.10b	74.0	11.1	2.24	0.70	64.7	23.8	2.06	0.30
+-----+-----+-----+-----+-----+-----+-----+-----+-----+-----+									
0	Eq. 6.10a	54.9	8.0	1.63	0.70	25.3	16.8	1.45	0.30
	Eq. 6.10b	55.7	8.0	1.62	0.70	24.8	16.7	1.45	0.30
+-----+-----+-----+-----+-----+-----+-----+-----+-----+-----+									
-1	Eq. 6.10a	47.7	7.1	1.43	0.70	48.9	15.5	1.34	0.30
	Eq. 6.10b	48.0	7.1	1.43	0.70	49.6	15.5	1.34	0.30
+-----+-----+-----+-----+-----+-----+-----+-----+-----+-----+									

GEOMETRY & LONGITUDINAL REINFORCEMENT

+-----+-----+-----+-----+-----+-----+-----+-----+-----+-----+									
Storey 6	Clear height(m):2.50 hcr(m):0.70 X-sect. RECT by(m):0.30 bz(m):0.70								
+-----+-----+-----+-----+-----+-----+-----+-----+-----+-----+									
Vertical steel ratio:	0.0097, Bars: 4Φ16 & 8Φ14								
	2Φ16 & 1Φ14 along by 2Φ16 & 3Φ14 along bz								
+-----+-----+-----+-----+-----+-----+-----+-----+-----+-----+									
Storey 5	Clear height(m):2.50 hcr(m):0.70 X-sect. RECT by(m):0.30 bz(m):0.70								
+-----+-----+-----+-----+-----+-----+-----+-----+-----+-----+									
Vertical steel ratio:	0.0097, Bars: 4Φ16 & 8Φ14								
	2Φ16 & 1Φ14 along by 2Φ16 & 3Φ14 along bz								
+-----+-----+-----+-----+-----+-----+-----+-----+-----+-----+									
Storey 4	Clear height(m):2.50 hcr(m):0.70 X-sect. RECT by(m):0.30 bz(m):0.70								
+-----+-----+-----+-----+-----+-----+-----+-----+-----+-----+									
Vertical steel ratio:	0.0097, Bars: 4Φ16 & 8Φ14								
	2Φ16 & 1Φ14 along by 2Φ16 & 3Φ14 along bz								
+-----+-----+-----+-----+-----+-----+-----+-----+-----+-----+									
Storey 3	Clear height(m):2.50 hcr(m):0.70 X-sect. RECT by(m):0.30 bz(m):0.70								
+-----+-----+-----+-----+-----+-----+-----+-----+-----+-----+									
Vertical steel ratio:	0.0097, Bars: 4Φ16 & 8Φ14								
	2Φ16 & 1Φ14 along by 2Φ16 & 3Φ14 along bz								
+-----+-----+-----+-----+-----+-----+-----+-----+-----+-----+									

```

+-----+
|Storey  2 Clear height(m):2.50 hcr(m):0.70 X-sect. RECT by(m):0.30 bz(m):0.70|
+-----+
| Vertical steel ratio: 0.0097, Bars:  4Φ16 &  8Φ14 |
|           2Φ16 &  1Φ14 along by  2Φ16 &  3Φ14 along bz |
+-----+
|Storey  1 Clear height(m):3.50 hcr(m):0.70 X-sect. RECT by(m):0.30 bz(m):0.70|
+-----+
| Vertical steel ratio: 0.0097, Bars:  4Φ16 &  8Φ14 |
|           2Φ16 &  1Φ14 along by  2Φ16 &  3Φ14 along bz |
+-----+
|Storey  0 Clear height(m):2.50 hcr(m):0.70 X-sect. RECT by(m):0.30 bz(m):0.70|
+-----+
| Vertical steel ratio: 0.0097, Bars:  4Φ16 &  8Φ14 |
|           2Φ16 &  1Φ14 along by  2Φ16 &  3Φ14 along bz |
+-----+
|Storey -1 Clear height(m):2.50 hcr(m):0.70 X-sect. RECT by(m):0.30 bz(m):0.70|
+-----+
| Vertical steel ratio: 0.0097, Bars:  4Φ16 &  8Φ14 |
|           2Φ16 &  1Φ14 along by  2Φ16 &  3Φ14 along bz |
+-----+
|Starter bars at base:  4Φ16 &  8Φ14 |
|           2Φ16 &  1Φ14 along by  2Φ16 &  3Φ14 along bz |
+-----+

```

COLUMN DESIGN MOMENT RESISTANCE MRd,c (for minN/maxN)

```

+-----+
|Storey|Locat.|          Direction of MRd Vector          :          |
|      |      |          +y          |          -y          |          +z          |          -z          |
+-----+-----+-----+-----+-----+-----+-----+-----+
|      |      |      (kNm)      |      (kNm)      |      (kNm)      |      (kNm)      |
+-----+-----+-----+-----+-----+-----+-----+
|   6 | Top | 369.6/ 376.6 | -369.6/ -376.6 | 102.9/ 107.5 | -102.9/ -107.5 |
|     | Base | 372.5/ 379.5 | -372.5/ -379.5 | 104.8/ 109.3 | -104.8/ -109.3 |
+-----+-----+-----+-----+-----+-----+-----+
|   5 | Top | 395.3/ 410.7 | -395.3/ -410.7 | 119.3/ 128.8 | -119.3/ -128.8 |
|     | Base | 397.9/ 413.1 | -397.9/ -413.1 | 120.9/ 130.3 | -120.9/ -130.3 |
+-----+-----+-----+-----+-----+-----+-----+
|   4 | Top | 418.1/ 438.8 | -418.1/ -438.8 | 133.4/ 146.1 | -133.4/ -146.1 |
|     | Base | 420.4/ 440.8 | -420.4/ -440.8 | 134.8/ 147.3 | -134.8/ -147.3 |
+-----+-----+-----+-----+-----+-----+-----+
|   3 | Top | 438.0/ 461.0 | -438.0/ -461.0 | 145.6/ 159.9 | -145.6/ -159.9 |
|     | Base | 440.0/ 462.5 | -440.0/ -462.5 | 146.8/ 160.8 | -146.8/ -160.8 |
+-----+-----+-----+-----+-----+-----+-----+
|   2 | Top | 455.2/ 477.2 | -455.2/ -477.2 | 156.2/ 170.4 | -156.2/ -170.4 |
+-----+-----+-----+-----+-----+-----+-----+

```

	Base	456.8/ 478.2	-456.8/ -478.2	157.2/ 171.1	-157.2/ -171.1
+-----+					
1	Top	469.6/ 487.4	-469.6/ -487.4	165.4/ 181.4	-165.4/ -181.4
	Base	471.3/ 488.2	-471.3/ -488.2	166.5/ 181.6	-166.5/ -181.6
+-----+					
0	Top	489.4/ 492.7	-489.4/ -492.7	181.8/ 183.2	-181.8/ -183.2
	Base	490.1/ 492.4	-490.1/ -492.4	182.0/ 182.4	-182.0/ -182.4
+-----+					
-1	Top	491.8/ 486.3	-491.8/ -486.3	181.1/ 169.7	-181.1/ -169.7
	Base	491.4/ 484.4	-491.4/ -484.4	180.3/ 168.9	-180.3/ -168.9
+-----+					

SUM OF BEAM DESIGN MOMENT RESISTANCES, MRd,b, AROUND JOINT

Storey Locat.		Direction of MRd Vector :			
		+y	-y	+z	-z
		(kNm)	(kNm)	(kNm)	(kNm)
6	Top	149.3	149.3	59.0	108.3
	Base	294.4	249.6	116.4	187.6
+-----+					
5	Top	294.4	249.6	116.4	187.6
	Base	294.4	249.6	116.4	186.0
+-----+					
4	Top	294.4	249.6	116.4	186.0
	Base	315.2	259.0	116.4	187.6
+-----+					
3	Top	315.2	259.0	116.4	187.6
	Base	281.7	258.1	87.9	157.3
+-----+					
2	Top	281.7	258.1	87.9	157.3
	Base	272.6	241.0	87.9	126.8
+-----+					
1	Top	272.6	241.0	87.9	126.8
	Base	168.5	168.5	188.5	208.8
+-----+					
0	Top	168.5	168.5	188.5	208.8
	Base	131.7	131.7	188.5	208.8
+-----+					
-1	Top	131.7	131.7	188.5	208.8
	Base	0.0	0.0	0.0	0.0
+-----+					

DESIGN OF TRANSVERSE REINFORCEMENT IN SHEAR (for maxN/minN)

Storey	Des. Shear		Provided Ties				strut angle		VR,s		VR,max	
	VEd (kN)		dia. legs		spacing-s		(deg)		(middle-kN)		(middle-kN)	
	y	z	(mm)	y	z	middle-mm	y	z	y	z	y	z
6 maxN	66.	47.	6	3.0	5.0	170	22	22	363.	219.	545.	490.
6 minN	66.	45.					22	22	350.	215.	545.	490.
5 maxN	68.	24.	6	3.0	5.0	170	22	22	412.	235.	545.	490.
5 minN	67.	24.					22	22	385.	226.	545.	490.
4 maxN	67.	23.	6	3.0	5.0	170	22	22	460.	251.	545.	490.
4 minN	67.	23.					22	22	420.	238.	545.	490.
3 maxN	71.	23.	6	3.0	5.0	170	22	22	508.	268.	545.	490.
3 minN	71.	23.					22	22	455.	250.	545.	490.
2 maxN	63.	19.	6	3.0	5.0	170	22	22	547.	283.	556.	490.
2 minN	63.	19.					22	22	490.	262.	545.	490.
1 maxN	43.	11.	6	3.0	5.0	170	22	22	521.	272.	545.	490.
1 minN	44.	11.					22	22	468.	254.	545.	490.
0 maxN	9.	1.	6	3.0	5.0	170	26	22	626.	327.	629.	490.
0 minN	9.	1.					24	22	581.	302.	584.	490.
-1 maxN	0.	1.	6	3.0	5.0	170	29	22	678.	356.	678.	490.
-1 minN	0.	1.					27	22	631.	330.	634.	490.

CONFINEMENT REINFORCEMENT AT COLUMN ENDS (for maxN/minN)

Story	Wwd-req.		aWwd-req.		Stirrups				Wwd-prov.		aWwd-prov.		
	base top		base top		dia. legs		spacing-mm		base top		base top		
			(mm)	y	z	base top							
6	0.00	0.00	0.000	0.000	6	3.0	5.0	110	110	0.177	0.177	0.055	0.055
5	0.00	0.00	0.000	0.000	6	3.0	5.0	110	110	0.177	0.177	0.055	0.055
4	0.00	0.00	0.000	0.000	6	3.0	5.0	110	110	0.177	0.177	0.055	0.055
3	0.00	0.00	0.000	0.000	6	3.0	5.0	110	110	0.177	0.177	0.055	0.055

G+ψ2Q+E -X -Y/maxN	-118.0	-67.6	329.4		-127.1	-15.8	313.6	
G+ψ2Q+E +X +Y/minN	123.3	15.5	246.7		122.2	66.3	231.0	
G+ψ2Q+E -X +Y/minN	-118.0	15.5	246.7		-127.1	66.3	231.0	
G+ψ2Q+E +X -Y/minN	123.3	-67.6	246.7		122.2	-15.8	231.0	
G+ψ2Q+E -X -Y/minN	-118.0	-67.6	246.7		-127.1	-15.8	231.0	

-----+

STOREY: 4	Base			Top				
Actions Combination	My	Mz	N	My	Mz	N		
	(kNm)	(kNm)	(kN)	(kNm)	(kNm)	(kN)		
EN1990 Eq. 6.10a	4.0	-40.2	648.6		-4.2	40.4	627.4	
EN1990 Eq. 6.10b	3.8	-38.3	611.2		-4.0	38.4	593.1	
G+ψ2Q+E +X +Y/maxN	134.7	16.0	499.6		132.5	68.7	483.8	
G+ψ2Q+E -X +Y/maxN	-129.5	16.0	499.6		-137.9	68.7	483.8	
G+ψ2Q+E +X -Y/maxN	134.7	-69.1	499.6		132.5	-15.4	483.8	
G+ψ2Q+E -X -Y/maxN	-129.5	-69.1	499.6		-137.9	-15.4	483.8	
G+ψ2Q+E +X +Y/minN	134.7	16.0	367.2		132.5	68.7	351.4	
G+ψ2Q+E -X +Y/minN	-129.5	16.0	367.2		-137.9	68.7	351.4	
G+ψ2Q+E +X -Y/minN	134.7	-69.1	367.2		132.5	-15.4	351.4	
G+ψ2Q+E -X -Y/minN	-129.5	-69.1	367.2		-137.9	-15.4	351.4	

-----+

STOREY: 3	Base			Top				
Actions Combination	My	Mz	N	My	Mz	N		
	(kNm)	(kNm)	(kN)	(kNm)	(kNm)	(kN)		
EN1990 Eq. 6.10a	3.5	-38.6	865.7		-3.6	39.2	844.5	
EN1990 Eq. 6.10b	3.3	-36.7	815.8		-3.5	37.4	797.7	
G+ψ2Q+E +X +Y/maxN	138.4	15.0	668.8		127.1	64.6	653.0	
G+ψ2Q+E -X +Y/maxN	-133.9	15.0	668.8		-131.9	64.6	653.0	
G+ψ2Q+E +X -Y/maxN	138.4	-65.9	668.8		127.1	-12.8	653.0	
G+ψ2Q+E -X -Y/maxN	-133.9	-65.9	668.8		-131.9	-12.8	653.0	
G+ψ2Q+E +X +Y/minN	138.4	15.0	488.1		127.1	64.6	472.3	
G+ψ2Q+E -X +Y/minN	-133.9	15.0	488.1		-131.9	64.6	472.3	
G+ψ2Q+E +X -Y/minN	138.4	-65.9	488.1		127.1	-12.8	472.3	
G+ψ2Q+E -X -Y/minN	-133.9	-65.9	488.1		-131.9	-12.8	472.3	

-----+

STOREY: 2	Base			Top				
Actions Combination	My	Mz	N	My	Mz	N		
	(kNm)	(kNm)	(kN)	(kNm)	(kNm)	(kN)		
EN1990 Eq. 6.10a	3.3	-45.2	1082.6		-3.3	41.4	1061.3	
EN1990 Eq. 6.10b	3.1	-43.1	1020.1		-3.1	39.4	1002.0	
G+ψ2Q+E +X +Y/maxN	136.8	6.7	835.2		112.4	59.7	819.4	
G+ψ2Q+E -X +Y/maxN	-132.5	6.7	835.2		-116.7	59.7	819.4	
G+ψ2Q+E +X -Y/maxN	136.8	-66.5	835.2		112.4	-4.9	819.4	

G+ψ2Q+E -X -Y/maxN	-10.8	0.4	1640.2		-14.9	-11.2	1619.2	
G+ψ2Q+E +X +Y/minN	10.9	8.0	1384.1		14.6	-6.0	1363.1	
G+ψ2Q+E -X +Y/minN	-10.8	8.0	1384.1		-14.9	-6.0	1363.1	
G+ψ2Q+E +X -Y/minN	10.9	0.4	1384.1		14.6	-11.2	1363.1	
G+ψ2Q+E -X -Y/minN	-10.8	0.4	1384.1		-14.9	-11.2	1363.1	

FOR NEGLIGIBLE 2ND-ORDER EFFECTS IN COLUMN, per EC2 pa.5.8.3.1, 5.8.3.2, 5.8.7.2

Storey	Combination	column direction x				column direction z					
		of actions	slenderness	column	slenderness	column	of actions	slenderness	column		
		per EN1990	limit	actual	eff.10	req.size	per EN1990	limit	actual	eff.10	req.size
		(m)				(m)					
6	Eq. 6.10a	186.2	8.0	1.61	0.70	196.4	17.4	1.51	0.30		
	Eq. 6.10b	188.2	8.0	1.61	0.70	198.6	17.4	1.51	0.30		
5	Eq. 6.10a	127.3	7.9	1.60	0.70	134.5	17.4	1.51	0.30		
	Eq. 6.10b	129.2	7.9	1.60	0.70	136.6	17.4	1.51	0.30		
4	Eq. 6.10a	116.9	7.9	1.60	0.70	118.8	17.5	1.52	0.30		
	Eq. 6.10b	118.8	7.9	1.60	0.70	120.7	17.5	1.52	0.30		
3	Eq. 6.10a	101.7	7.9	1.60	0.70	102.9	17.6	1.53	0.30		
	Eq. 6.10b	103.4	7.9	1.60	0.70	104.6	17.6	1.53	0.30		
2	Eq. 6.10a	92.7	8.0	1.61	0.70	92.4	17.9	1.55	0.30		
	Eq. 6.10b	94.3	8.0	1.61	0.70	94.2	17.8	1.54	0.30		
1	Eq. 6.10a	77.2	11.1	2.24	0.70	62.1	23.9	2.07	0.30		
	Eq. 6.10b	78.5	11.1	2.24	0.70	63.1	23.9	2.07	0.30		
0	Eq. 6.10a	62.5	8.1	1.63	0.70	69.1	16.8	1.45	0.30		
	Eq. 6.10b	63.6	8.1	1.63	0.70	70.4	16.7	1.45	0.30		
-1	Eq. 6.10a	51.9	7.1	1.42	0.70	52.7	15.5	1.34	0.30		
	Eq. 6.10b	52.8	7.0	1.42	0.70	53.6	15.5	1.34	0.30		

GEOMETRY & LONGITUDINAL REINFORCEMENT

Storey	6	Clear height(m):2.50	hcr(m):0.70	X-sect. RECT	by(m):0.30	bz(m):0.70
Vertical steel ratio: 0.0097, Bars: 4Φ16 & 8Φ14						
2Φ16 & 1Φ14 along by 2Φ16 & 3Φ14 along bz						

```

+-----+
|Storey 5 Clear height(m):2.50 hcr(m):0.70 X-sect. RECT by(m):0.30 bz(m):0.70|
+-----+
| Vertical steel ratio: 0.0097, Bars: 4Φ16 & 8Φ14 |
|           2Φ16 & 1Φ14 along by 2Φ16 & 3Φ14 along bz |
+-----+
|Storey 4 Clear height(m):2.50 hcr(m):0.70 X-sect. RECT by(m):0.30 bz(m):0.70|
+-----+
| Vertical steel ratio: 0.0097, Bars: 4Φ16 & 8Φ14 |
|           2Φ16 & 1Φ14 along by 2Φ16 & 3Φ14 along bz |
+-----+
|Storey 3 Clear height(m):2.50 hcr(m):0.70 X-sect. RECT by(m):0.30 bz(m):0.70|
+-----+
| Vertical steel ratio: 0.0097, Bars: 4Φ16 & 8Φ14 |
|           2Φ16 & 1Φ14 along by 2Φ16 & 3Φ14 along bz |
+-----+
|Storey 2 Clear height(m):2.50 hcr(m):0.70 X-sect. RECT by(m):0.30 bz(m):0.70|
+-----+
| Vertical steel ratio: 0.0097, Bars: 4Φ16 & 8Φ14 |
|           2Φ16 & 1Φ14 along by 2Φ16 & 3Φ14 along bz |
+-----+
|Storey 1 Clear height(m):3.50 hcr(m):0.70 X-sect. RECT by(m):0.30 bz(m):0.70|
+-----+
| Vertical steel ratio: 0.0097, Bars: 4Φ16 & 8Φ14 |
|           2Φ16 & 1Φ14 along by 2Φ16 & 3Φ14 along bz |
+-----+
|Storey 0 Clear height(m):2.50 hcr(m):0.70 X-sect. RECT by(m):0.30 bz(m):0.70|
+-----+
| Vertical steel ratio: 0.0097, Bars: 4Φ16 & 8Φ14 |
|           2Φ16 & 1Φ14 along by 2Φ16 & 3Φ14 along bz |
+-----+
|Storey -1 Clear height(m):2.50 hcr(m):0.70 X-sect. RECT by(m):0.30 bz(m):0.70|
+-----+
| Vertical steel ratio: 0.0097, Bars: 4Φ16 & 8Φ14 |
|           2Φ16 & 1Φ14 along by 2Φ16 & 3Φ14 along bz |
+-----+
|Starter bars at base: 4Φ16 & 8Φ14 |
|           2Φ16 & 1Φ14 along by 2Φ16 & 3Φ14 along bz |
+-----+
                COLUMN DESIGN MOMENT RESISTANCE MRd,c (for minN/maxN)
+-----+
|Storey|Locat.|           Direction of MRd Vector           :           |

```

			+y		-y		+z		-z	
		(kNm)		(kNm)		(kNm)		(kNm)		
6	Top	364.7/	370.8	-364.7/	-370.8	99.8/	103.7	-99.8/	-103.7	
	Base	367.8/	373.7	-367.8/	-373.7	101.8/	105.6	-101.8/	-105.6	
5	Top	386.9/	400.9	-386.9/	-400.9	114.0/	122.7	-114.0/	-122.7	
	Base	389.7/	403.5	-389.7/	-403.5	115.7/	124.3	-115.7/	-124.3	
4	Top	407.0/	426.6	-407.0/	-426.6	126.5/	138.6	-126.5/	-138.6	
	Base	409.4/	428.7	-409.4/	-428.7	128.0/	139.9	-128.0/	-139.9	
3	Top	425.0/	447.9	-425.0/	-447.9	137.6/	151.7	-137.6/	-151.7	
	Base	427.2/	449.7	-427.2/	-449.7	139.0/	152.8	-139.0/	-152.8	
2	Top	441.2/	464.9	-441.2/	-464.9	147.6/	162.4	-147.6/	-162.4	
	Base	443.1/	466.3	-443.1/	-466.3	148.7/	163.3	-148.7/	-163.3	
1	Top	455.6/	477.3	-455.6/	-477.3	156.5/	170.5	-156.5/	-170.5	
	Base	457.7/	478.7	-457.7/	-478.7	157.8/	171.4	-157.8/	-171.4	
0	Top	481.4/	491.6	-481.4/	-491.6	173.3/	182.2	-173.3/	-182.2	
	Base	482.6/	492.0	-482.6/	-492.0	174.1/	182.2	-174.1/	-182.2	
-1	Top	492.6/	490.8	-492.6/	-490.8	182.1/	179.4	-182.1/	-179.4	
	Base	492.8/	490.2	-492.8/	-490.2	182.0/	178.6	-182.0/	-178.6	

SUM OF BEAM DESIGN MOMENT RESISTANCES, MRd,b, AROUND JOINT

Storey	Locat.	Direction of MRd Vector :			
		+y	-y	+z	-z
		(kNm)		(kNm)	
6	Top	233.3	175.1	59.0	108.3
	Base	272.6	272.6	87.9	144.7
5	Top	272.6	272.6	87.9	144.7
	Base	272.6	272.6	87.9	133.3
4	Top	272.6	272.6	87.9	133.3
	Base	281.7	281.7	87.9	133.3
3	Top	281.7	281.7	87.9	133.3
	Base	272.6	272.6	87.9	126.8

2	Top	272.6	272.6	87.9	126.8
	Base	259.0	259.0	59.0	108.3
1	Top	259.0	259.0	59.0	108.3
	Base	131.7	131.7	188.5	158.7
0	Top	131.7	131.7	188.5	158.7
	Base	131.7	131.7	204.3	149.5
-1	Top	131.7	131.7	204.3	149.5
	Base	0.0	0.0	0.0	0.0

DESIGN OF TRANSVERSE REINFORCEMENT IN SHEAR (for maxN/minN)

Storey	Des. Shear		Provided Ties			strut angle		VR,s		VR,max		
	VEd (kN)		dia.	legs	spacing-s	(deg)		(middle-kN)		(middle-kN)		
	y	z	(mm)	y	z	middle-mm	y	z	y	z	y	z
6 maxN	103.	46.	6	3.0	5.0	170	22	22	355.	216.	545.	490.
minN	103.	44.					22	22	344.	213.	545.	490.
5 maxN	62.	18.	6	3.0	5.0	170	22	22	397.	230.	545.	490.
minN	62.	18.					22	22	373.	222.	545.	490.
4 maxN	62.	16.	6	3.0	5.0	170	22	22	438.	244.	545.	490.
minN	61.	16.					22	22	402.	232.	545.	490.
3 maxN	63.	16.	6	3.0	5.0	170	22	22	478.	258.	545.	490.
minN	63.	16.					22	22	431.	242.	545.	490.
2 maxN	61.	15.	6	3.0	5.0	170	22	22	518.	271.	545.	490.
minN	61.	15.					22	22	461.	252.	545.	490.
1 maxN	41.	9.	6	3.0	5.0	170	22	22	489.	261.	545.	490.
minN	41.	9.					22	22	442.	245.	545.	490.
0 maxN	9.	6.	6	3.0	5.0	170	25	22	594.	310.	599.	490.
minN	9.	6.					23	22	555.	288.	562.	490.
-1 maxN	0.	6.	6	3.0	5.0	170	27	22	641.	336.	643.	490.
minN	0.	6.					25	22	601.	313.	605.	490.

-----+-----													
CONFINEMENT REINFORCEMENT AT COLUMN ENDS (for maxN/minN)													
-----+-----													
Story	Wwd-req.		aWwd-req.		Stirrups					Wwd-prov.		aWwd-prov.	
		base top	base top	dia.	legs	spacing-mm	base top	base top					
			(mm)	y	z	base top							
-----+-----													
6	0.00	0.00	0.000	0.000	6	3.0	5.0	110	110	0.177	0.177	0.055	0.055
5	0.00	0.00	0.000	0.000	6	3.0	5.0	110	110	0.177	0.177	0.055	0.055
4	0.00	0.00	0.000	0.000	6	3.0	5.0	110	110	0.177	0.177	0.055	0.055
3	0.00	0.00	0.000	0.000	6	3.0	5.0	110	110	0.177	0.177	0.055	0.055
2	0.00	0.00	0.000	0.000	6	3.0	5.0	110	110	0.177	0.177	0.055	0.055
1	0.08	0.00	0.110	0.000	8	3.0	5.0	100	110	0.346	0.315	0.113	0.098
0	0.00	0.00	0.000	0.000	6	3.0	5.0	110	110	0.177	0.177	0.055	0.055
-1	0.00	0.00	0.000	0.000	6	3.0	5.0	110	110	0.177	0.177	0.055	0.055
-----+-----													

3A 3. DESIGN OF BEAMS IN SHEAR

3A 3.1. FRAME A

-----+-----													
SHEAR FORCES - ULS DESIGN OF TRANSVERSE REINFORCEMENT													
-----+-----													
* Concrete: C25 - Long. Reinforcement: S500 - Stirrups: S500 - Cover: 35 (mm) *													
-----+-----													
STOREY:	6	* BEAMS:	1	2	3	4	5						
-----+-----													
SUM OF BEAM/COLUMN DESIGN MOMENT RESISTANCES, SMRd,b/SMRd,c, AROUND JOINT													
-----+-----													
Beam	Beam end & direction of MRd Vector:												
	Left End	+y	Left End	-y	Right End	+y	Right End	-y					

```

+-----+----- (kNm) -----+----- (kNm) -----+----- (kNm) -----+----- (kNm) -----+
*-----*
| 1 | 83.4 / 102.9 | 58.5 / 102.9 | 186.8 / 377.2 | 226.6 / 377.2 |
| 2 | 186.8 / 377.2 | 226.6 / 377.2 | 241.0 / 370.8 | 241.0 / 370.8 |
| 3 | 241.0 / 370.8 | 241.0 / 370.8 | 241.0 / 370.8 | 241.0 / 370.8 |
| 4 | 241.0 / 370.8 | 241.0 / 370.8 | 226.6 / 377.2 | 186.8 / 377.2 |
| 5 | 226.6 / 377.2 | 186.8 / 377.2 | 58.5 / 102.9 | 83.4 / 102.9 |
+-----+
|Beam: 1 |
| Seismic Shear (kN)- L End: maxVEd: 57.3 minVEd: -0.2 minV/maxV: 0.00|
| Seismic Shear (kN)- L End: maxVEd: 70.7 minVEd: 13.2 minV/maxV: 0.19|
|-----|
|Region|Length|Ties design shear|max tie|Prov. ties | strut | VR,s | VR,max |
| | |Seismic Non-Seis.|spacing| No. Φ s | angle |provided|provided|
|-----+-(m)---+----- (kN) -----+-(mm)---+----- (mm)---+-(deg)---+-(kN)---+-(kN)---|
|L End | 0.50| 51.4 41.4| 112 | 6 8 110 | 23 | 367.7 | 367.7 |
|Centre| 4.40| 58.9 38.7| 330 | 15 8 330 | 22 | 133.2 | 346.8 |
|R End | 0.50| 64.8 47.6| 96 | 7 8 95 | 23 | 389.7 | 389.7 |
+-----+
|Beam: 2 |
| Seismic Shear (kN)- L End: maxVEd: 79.4 minVEd: -12.3 minV/maxV:-0.16|
| Seismic Shear (kN)- L End: maxVEd: 82.8 minVEd: -8.9 minV/maxV:-0.11|
|-----|
|Region|Length|Ties design shear|max tie|Prov. ties | strut | VR,s | VR,max |
| | |Seismic Non-Seis.|spacing| No. Φ s | angle |provided|provided|
|-----+-(m)---+----- (kN) -----+-(mm)---+----- (mm)---+-(deg)---+-(kN)---+-(kN)---|
|L End | 0.50| 73.5 43.0| 96 | 7 8 95 | 25 | 389.7 | 389.7 |
|Centre| 4.30| 71.1 37.1| 330 | 15 8 330 | 22 | 133.2 | 346.8 |
|R End | 0.50| 77.0 46.0| 112 | 6 8 110 | 25 | 367.7 | 367.7 |
+-----+
|Beam: 3 |
| Seismic Shear (kN)- L End: maxVEd: 80.0 minVEd: -11.0 minV/maxV:-0.14|
| Seismic Shear (kN)- L End: maxVEd: 80.0 minVEd: -11.0 minV/maxV:-0.14|
|-----|
|Region|Length|Ties design shear|max tie|Prov. ties | strut | VR,s | VR,max |
| | |Seismic Non-Seis.|spacing| No. Φ s | angle |provided|provided|
|-----+-(m)---+----- (kN) -----+-(mm)---+----- (mm)---+-(deg)---+-(kN)---+-(kN)---|
|L End | 0.50| 74.2 43.6| 112 | 6 8 110 | 23 | 367.7 | 367.7 |
|Centre| 4.30| 68.5 34.8| 330 | 15 8 330 | 22 | 133.2 | 346.8 |
|R End | 0.50| 74.2 43.6| 112 | 6 8 110 | 23 | 367.7 | 367.7 |
+-----+
|Beam: 4 |

```

Seismic Shear (kN)- L End: maxVED: 82.8 minVED: -8.9 minV/maxV:-0.11|
 Seismic Shear (kN)- L End: maxVED: 79.4 minVED: -12.3 minV/maxV:-0.16|

Region	Length	Ties design shear	max tie	Prov. ties	strut	VR,s	VR,max
		Seismic Non-Seis.	spacing	No. Φ	s	angle	provided provided
-----+- (m)-----	----- (kN)-----	-----+- (mm)-----	----- (mm)-----	----- (deg)-----	----- (kN)-----	----- (kN)-----	
L End	0.50	77.0	46.0	112	6 8 110	23	367.7 367.7
Centre	4.30	71.1	37.1	330	15 8 330	22	133.2 346.8
R End	0.50	73.5	43.0	96	7 8 95	23	389.7 389.7

Beam: 5
 Seismic Shear (kN)- L End: maxVED: 70.7 minVED: 13.2 minV/maxV: 0.19|
 Seismic Shear (kN)- L End: maxVED: 57.3 minVED: -0.2 minV/maxV: 0.00|

Region	Length	Ties design shear	max tie	Prov. ties	strut	VR,s	VR,max
		Seismic Non-Seis.	spacing	No. Φ	s	angle	provided provided
-----+- (m)-----	----- (kN)-----	-----+- (mm)-----	----- (mm)-----	----- (deg)-----	----- (kN)-----	----- (kN)-----	
L End	0.50	64.8	47.6	96	7 8 95	25	389.7 389.7
Centre	4.40	58.9	38.7	330	15 8 330	22	133.2 346.8
R End	0.50	51.4	41.4	112	6 8 110	25	367.7 367.7

STOREY: 5 * BEAMS: 1 2 3 4 5

SUM OF BEAM/COLUMN DESIGN MOMENT RESISTANCES, SMRd,b/SMRd,c, AROUND JOINT

Beam	Beam end & direction of MRd Vector:			
	Left End +y	Left End -y	Right End +y	Right End -y
-----+-----	-----+-----	-----+-----	-----+-----	-----+-----
	(kNm)	(kNm)	(kNm)	(kNm)
1	134.6 / 224.5	86.9 / 224.5	280.3 / 789.1	263.0 / 789.1
2	280.3 / 789.1	263.0 / 789.1	281.7 / 771.9	281.7 / 771.9
3	281.7 / 771.9	281.7 / 771.9	281.7 / 771.9	281.7 / 771.9
4	281.7 / 771.9	281.7 / 771.9	263.0 / 789.1	280.3 / 789.1
5	263.0 / 789.1	280.3 / 789.1	86.9 / 224.5	134.6 / 224.5

Beam: 1
 Seismic Shear (kN)- L End: maxVED: 82.9 minVED: -6.8 minV/maxV:-0.08|
 Seismic Shear (kN)- L End: maxVED: 77.3 minVED: -12.4 minV/maxV:-0.16|

Region	Length	Ties design shear	max tie	Prov. ties	strut	VR,s	VR,max
		Seismic Non-Seis.	spacing	No. Φ	s	angle	provided provided

```

|-----+- (m) ---+----- (kN) -----+- (mm) --+----- (mm) --+- (deg) -+- (kN) ---+ (kN) --|
|L End | 0.50| 77.0 45.2| 112 | 6 8 110 | 23 | 367.7 | 367.7 |
|Centre| 4.40| 71.1 36.3| 330 | 15 8 330 | 22 | 133.2 | 346.8 |
|R End | 0.50| 71.5 43.8| 112 | 6 8 110 | 23 | 367.7 | 367.7 |
+-----+
|Beam: 2 |
| Seismic Shear (kN)- L End: maxVED: 85.2 minVED: -20.8 minV/maxV:-0.24|
| Seismic Shear (kN)- L End: maxVED: 91.3 minVED: -14.7 minV/maxV:-0.16|
+-----+
|Region|Length|Ties design shear|max tie|Prov. ties | strut | VR,s | VR,max |
| | |Seismic Non-Seis.|spacing| No. Φ s | angle |provided|provided|
|-----+- (m) ---+----- (kN) -----+- (mm) --+----- (mm) --+- (deg) -+- (kN) ---+ (kN) --|
|L End | 0.50| 79.4 42.4| 112 | 6 8 110 | 23 | 367.7 | 367.7 |
|Centre| 4.30| 79.5 37.7| 330 | 15 8 330 | 22 | 133.2 | 346.8 |
|R End | 0.50| 85.4 46.5| 112 | 6 8 110 | 23 | 367.7 | 367.7 |
+-----+
|Beam: 3 |
| Seismic Shear (kN)- L End: maxVED: 87.7 minVED: -18.6 minV/maxV:-0.21|
| Seismic Shear (kN)- L End: maxVED: 87.7 minVED: -18.6 minV/maxV:-0.21|
+-----+
|Region|Length|Ties design shear|max tie|Prov. ties | strut | VR,s | VR,max |
| | |Seismic Non-Seis.|spacing| No. Φ s | angle |provided|provided|
|-----+- (m) ---+----- (kN) -----+- (mm) --+----- (mm) --+- (deg) -+- (kN) ---+ (kN) --|
|L End | 0.50| 81.9 43.6| 112 | 6 8 110 | 23 | 367.7 | 367.7 |
|Centre| 4.30| 76.1 34.8| 330 | 15 8 330 | 22 | 133.2 | 346.8 |
|R End | 0.50| 81.9 43.6| 112 | 6 8 110 | 23 | 367.7 | 367.7 |
+-----+
|Beam: 4 |
| Seismic Shear (kN)- L End: maxVED: 91.3 minVED: -14.7 minV/maxV:-0.16|
| Seismic Shear (kN)- L End: maxVED: 85.2 minVED: -20.8 minV/maxV:-0.24|
+-----+
|Region|Length|Ties design shear|max tie|Prov. ties | strut | VR,s | VR,max |
| | |Seismic Non-Seis.|spacing| No. Φ s | angle |provided|provided|
|-----+- (m) ---+----- (kN) -----+- (mm) --+----- (mm) --+- (deg) -+- (kN) ---+ (kN) --|
|L End | 0.50| 85.4 46.5| 112 | 6 8 110 | 23 | 367.7 | 367.7 |
|Centre| 4.30| 79.5 37.7| 330 | 15 8 330 | 22 | 133.2 | 346.8 |
|R End | 0.50| 79.4 42.4| 112 | 6 8 110 | 23 | 367.7 | 367.7 |
+-----+
|Beam: 5 |
| Seismic Shear (kN)- L End: maxVED: 77.3 minVED: -12.4 minV/maxV:-0.16|
| Seismic Shear (kN)- L End: maxVED: 82.9 minVED: -6.8 minV/maxV:-0.08|
+-----+

```

Region	Length	Ties design shear	max tie	Prov. ties	strut	VR,s	VR,max
		Seismic Non-Seis.	spacing	No. Φ s	angle	provided	provided
-----+- (m) --+----- (kN) -----+- (mm) --+----- (mm) --+- (deg) --+- (kN) --+- (kN) --							
L End	0.50	71.5	43.8	112	6 8 110	23	367.7 367.7
Centre	4.40	71.1	36.3	330	15 8 330	22	133.2 346.8
R End	0.50	77.0	45.2	112	6 8 110	23	367.7 367.7

-----+

STOREY: 4 * BEAMS: 1 2 3 4 5

SUM OF BEAM/COLUMN DESIGN MOMENT RESISTANCES, SMRd,b/SMRd,c, AROUND JOINT
+-----+

Beam	Beam end & direction of MRd Vector:			
	Left End +y	Left End -y	Right End +y	Right End -y
+-----+----- (kNm) -----+----- (kNm) -----+----- (kNm) -----+----- (kNm) -----+				
1	134.6 / 259.1	86.9 / 259.1	310.9 / 852.1	272.6 / 852.1
2	310.9 / 852.1	272.6 / 852.1	294.4 / 828.0	294.4 / 828.0
3	294.4 / 828.0	294.4 / 828.0	294.4 / 828.0	294.4 / 828.0
4	294.4 / 828.0	294.4 / 828.0	272.6 / 852.1	310.9 / 852.1
5	272.6 / 852.1	310.9 / 852.1	86.9 / 259.1	134.6 / 259.1

+-----+
|Beam: 1 |
| Seismic Shear (kN)- L End: maxVEd: 81.6 minVEd: -9.9 minV/maxV:-0.12|
Seismic Shear (kN)- L End: maxVEd: 80.4 minVEd: -11.1 minV/maxV:-0.14

Region	Length	Ties design shear	max tie	Prov. ties	strut	VR,s	VR,max
		Seismic Non-Seis.	spacing	No. Φ s	angle	provided	provided
-----+- (m) --+----- (kN) -----+- (mm) --+----- (mm) --+- (deg) --+- (kN) --+- (kN) --							
L End	0.50	75.7	44.3	112	6 8 110	23	367.7 367.7
Centre	4.40	69.8	35.8	330	15 8 330	22	133.2 346.8
R End	0.50	74.6	44.7	112	6 8 110	23	367.7 367.7

+-----+
|Beam: 2 |
| Seismic Shear (kN)- L End: maxVEd: 91.5 minVEd: -22.7 minV/maxV:-0.25|
Seismic Shear (kN)- L End: maxVEd: 93.2 minVEd: -21.0 minV/maxV:-0.23

Region	Length	Ties design shear	max tie	Prov. ties	strut	VR,s	VR,max
		Seismic Non-Seis.	spacing	No. Φ s	angle	provided	provided
-----+- (m) --+----- (kN) -----+- (mm) --+----- (mm) --+- (deg) --+- (kN) --+- (kN) --							
L End	0.50	85.6	42.8	112	6 8 110	23	367.7 367.7
Centre	4.30	81.5	37.3	330	15 8 330	22	133.2 346.8

```

|R End | 0.50| 87.3 46.2| 112 | 6 8 110 | 23 | 367.7 | 367.7 |
+-----+
|Beam: 3 |
| Seismic Shear (kN)- L End: maxVED: 90.1 minVED: -21.0 minV/maxV:-0.23|
| Seismic Shear (kN)- L End: maxVED: 90.1 minVED: -21.0 minV/maxV:-0.23|
|-----|
|Region|Length|Ties design shear|max tie|Prov. ties | strut | VR,s | VR,max |
| | |Seismic Non-Seis.|spacing| No. Φ s | angle |provided|provided|
|-----+-(m)---+------(kN)-----+-(mm)---+------(mm)---+-(deg)---+-(kN)---+-(kN)---|
|L End | 0.50| 84.3 43.6| 112 | 6 8 110 | 23 | 367.7 | 367.7 |
|Centre| 4.30| 78.6 34.8| 330 | 15 8 330 | 22 | 133.2 | 346.8 |
|R End | 0.50| 84.3 43.6| 112 | 6 8 110 | 23 | 367.7 | 367.7 |
+-----+
|Beam: 4 |
| Seismic Shear (kN)- L End: maxVED: 93.2 minVED: -21.0 minV/maxV:-0.23|
| Seismic Shear (kN)- L End: maxVED: 91.5 minVED: -22.7 minV/maxV:-0.25|
|-----|
|Region|Length|Ties design shear|max tie|Prov. ties | strut | VR,s | VR,max |
| | |Seismic Non-Seis.|spacing| No. Φ s | angle |provided|provided|
|-----+-(m)---+------(kN)-----+-(mm)---+------(mm)---+-(deg)---+-(kN)---+-(kN)---|
|L End | 0.50| 87.3 46.2| 112 | 6 8 110 | 23 | 367.7 | 367.7 |
|Centre| 4.30| 81.5 37.3| 330 | 15 8 330 | 22 | 133.2 | 346.8 |
|R End | 0.50| 85.6 42.8| 112 | 6 8 110 | 23 | 367.7 | 367.7 |
+-----+
|Beam: 5 |
| Seismic Shear (kN)- L End: maxVED: 80.4 minVED: -11.1 minV/maxV:-0.14|
| Seismic Shear (kN)- L End: maxVED: 81.6 minVED: -9.9 minV/maxV:-0.12|
|-----|
|Region|Length|Ties design shear|max tie|Prov. ties | strut | VR,s | VR,max |
| | |Seismic Non-Seis.|spacing| No. Φ s | angle |provided|provided|
|-----+-(m)---+------(kN)-----+-(mm)---+------(mm)---+-(deg)---+-(kN)---+-(kN)---|
|L End | 0.50| 74.6 44.7| 112 | 6 8 110 | 23 | 367.7 | 367.7 |
|Centre| 4.40| 69.8 35.8| 330 | 15 8 330 | 22 | 133.2 | 346.8 |
|R End | 0.50| 75.7 44.3| 112 | 6 8 110 | 23 | 367.7 | 367.7 |
+-----+
*-----*
STOREY: 3 * BEAMS: 1 2 3 4 5
*-----*
SUM OF BEAM/COLUMN DESIGN MOMENT RESISTANCES, SMRd,b/SMRd,c, AROUND JOINT
+-----+
| Beam| Beam end & direction of MRd Vector: |
| | Left End +y | Left End -y | Right End +y | Right End -y |

```

		(kNm)		(kNm)		(kNm)		(kNm)	
1	139.5 / 288.0	86.9 / 288.0	310.9 / 902.7	272.6 / 902.7	294.4 / 875.1	294.4 / 875.1	294.4 / 875.1	294.4 / 875.1	294.4 / 875.1
2	310.9 / 902.7	272.6 / 902.7	294.4 / 875.1	294.4 / 875.1	294.4 / 875.1	294.4 / 875.1	294.4 / 875.1	294.4 / 875.1	294.4 / 875.1
3	294.4 / 875.1	294.4 / 875.1	294.4 / 875.1	294.4 / 875.1	294.4 / 875.1	294.4 / 875.1	294.4 / 875.1	294.4 / 875.1	294.4 / 875.1
4	294.4 / 875.1	294.4 / 875.1	272.6 / 902.7	310.9 / 902.7	86.9 / 288.0	139.5 / 288.0			
5	272.6 / 902.7	310.9 / 902.7	86.9 / 288.0	139.5 / 288.0					
Beam: 1									
Seismic Shear (kN)- L End: maxVEd: 81.7 minVEd: -10.7 minV/maxV:-0.13									
Seismic Shear (kN)- L End: maxVEd: 81.2 minVEd: -11.2 minV/maxV:-0.14									
Region	Length	Ties design shear	max tie	Prov. ties	strut	VR,s	VR,max		
		Seismic Non-Seis.	spacing	No. Φ	s	angle	provided	provided	
	(m)	(kN)	(mm)	(mm)	(deg)	(kN)	(kN)		
L End	0.50	75.9	43.7	112	6 8 110	23	367.7	367.7	
Centre	4.40	70.0	36.4	330	15 8 330	22	133.2	346.8	
R End	0.50	75.3	45.2	112	6 8 110	23	367.7	367.7	
Beam: 2									
Seismic Shear (kN)- L End: maxVEd: 91.8 minVEd: -22.4 minV/maxV:-0.24									
Seismic Shear (kN)- L End: maxVEd: 92.9 minVEd: -21.3 minV/maxV:-0.23									
Region	Length	Ties design shear	max tie	Prov. ties	strut	VR,s	VR,max		
		Seismic Non-Seis.	spacing	No. Φ	s	angle	provided	provided	
	(m)	(kN)	(mm)	(mm)	(deg)	(kN)	(kN)		
L End	0.50	86.0	43.0	112	6 8 110	23	367.7	367.7	
Centre	4.30	81.1	37.1	330	15 8 330	22	133.2	346.8	
R End	0.50	87.0	46.0	112	6 8 110	23	367.7	367.7	
Beam: 3									
Seismic Shear (kN)- L End: maxVEd: 90.1 minVEd: -21.0 minV/maxV:-0.23									
Seismic Shear (kN)- L End: maxVEd: 90.1 minVEd: -21.0 minV/maxV:-0.23									
Region	Length	Ties design shear	max tie	Prov. ties	strut	VR,s	VR,max		
		Seismic Non-Seis.	spacing	No. Φ	s	angle	provided	provided	
	(m)	(kN)	(mm)	(mm)	(deg)	(kN)	(kN)		
L End	0.50	84.3	43.6	112	6 8 110	23	367.7	367.7	
Centre	4.30	78.6	34.8	330	15 8 330	22	133.2	346.8	
R End	0.50	84.3	43.6	112	6 8 110	23	367.7	367.7	
Beam: 4									

Seismic Shear (kN)- L End: maxVED: 92.9 minVED: -21.3 minV/maxV:-0.23|
 Seismic Shear (kN)- L End: maxVED: 91.8 minVED: -22.4 minV/maxV:-0.24|

Region	Length	Ties design shear	max tie	Prov. ties	strut	VR,s	VR,max
		Seismic Non-Seis.	spacing	No. Φ	s	angle	provided provided
-----+- (m)-----	----- (kN)-----	-----+- (mm)-----	----- (mm)-----	----- (deg)-----	----- (kN)-----	----- (kN)-----	
L End	0.50	87.0	46.0	112	6 8 110	23	367.7 367.7
Centre	4.30	81.1	37.1	330	15 8 330	22	133.2 346.8
R End	0.50	86.0	43.0	112	6 8 110	23	367.7 367.7

Beam: 5

Seismic Shear (kN)- L End: maxVED: 81.2 minVED: -11.2 minV/maxV:-0.14|
 Seismic Shear (kN)- L End: maxVED: 81.7 minVED: -10.7 minV/maxV:-0.13|

Region	Length	Ties design shear	max tie	Prov. ties	strut	VR,s	VR,max
		Seismic Non-Seis.	spacing	No. Φ	s	angle	provided provided
-----+- (m)-----	----- (kN)-----	-----+- (mm)-----	----- (mm)-----	----- (deg)-----	----- (kN)-----	----- (kN)-----	
L End	0.50	75.3	45.2	112	6 8 110	23	367.7 367.7
Centre	4.40	70.0	36.4	330	15 8 330	22	133.2 346.8
R End	0.50	75.9	43.7	112	6 8 110	23	367.7 367.7

STOREY: 2 * BEAMS: 1 2 3 4 5

SUM OF BEAM/COLUMN DESIGN MOMENT RESISTANCES, SMRd,b/SMRd,c, AROUND JOINT

Beam	Beam end & direction of MRd Vector:			
	Left End +y	Left End -y	Right End +y	Right End -y
-----+-----	-----+-----	-----+-----	-----+-----	-----+-----
	(kNm)	(kNm)	(kNm)	(kNm)
1	134.6 / 311.4	86.9 / 311.4	310.9 / 941.0	272.6 / 941.0
2	310.9 / 941.0	272.6 / 941.0	294.4 / 913.5	294.4 / 913.5
3	294.4 / 913.5	294.4 / 913.5	294.4 / 913.5	294.4 / 913.5
4	294.4 / 913.5	294.4 / 913.5	272.6 / 941.0	310.9 / 941.0
5	272.6 / 941.0	310.9 / 941.0	86.9 / 311.4	134.6 / 311.4

Beam: 1

Seismic Shear (kN)- L End: maxVED: 80.0 minVED: -11.5 minV/maxV:-0.14|
 Seismic Shear (kN)- L End: maxVED: 82.0 minVED: -9.5 minV/maxV:-0.12|

Region	Length	Ties design shear	max tie	Prov. ties	strut	VR,s	VR,max
		Seismic Non-Seis.	spacing	No. Φ	s	angle	provided provided

```

|-----+- (m) ---+----- (kN) -----+- (mm) --+----- (mm) --+- (deg) -+--- (kN) ---+--- (kN) --|
|L End | 0.50| 74.1 43.1| 112 | 6 8 110 | 23 | 367.7 | 367.7 |
|Centre| 4.40| 70.3 37.0| 330 | 15 8 330 | 22 | 133.2 | 346.8 |
|R End | 0.50| 76.2 45.9| 112 | 6 8 110 | 23 | 367.7 | 367.7 |
+-----+
|Beam: 2 |
| Seismic Shear (kN)- L End: maxVED: 92.3 minVED: -21.9 minV/maxV:-0.24|
| Seismic Shear (kN)- L End: maxVED: 92.4 minVED: -21.8 minV/maxV:-0.24|
+-----+
|Region|Length|Ties design shear|max tie|Prov. ties | strut | VR,s | VR,max |
| | |Seismic Non-Seis.|spacing| No. Φ s | angle |provided|provided|
|-----+- (m) ---+----- (kN) -----+- (mm) --+----- (mm) --+- (deg) -+--- (kN) ---+--- (kN) --|
|L End | 0.50| 86.4 43.4| 112 | 6 8 110 | 23 | 367.7 | 367.7 |
|Centre| 4.30| 80.7 36.7| 330 | 15 8 330 | 22 | 133.2 | 346.8 |
|R End | 0.50| 86.5 45.6| 112 | 6 8 110 | 23 | 367.7 | 367.7 |
+-----+
|Beam: 3 |
| Seismic Shear (kN)- L End: maxVED: 90.1 minVED: -21.0 minV/maxV:-0.23|
| Seismic Shear (kN)- L End: maxVED: 90.1 minVED: -21.0 minV/maxV:-0.23|
+-----+
|Region|Length|Ties design shear|max tie|Prov. ties | strut | VR,s | VR,max |
| | |Seismic Non-Seis.|spacing| No. Φ s | angle |provided|provided|
|-----+- (m) ---+----- (kN) -----+- (mm) --+----- (mm) --+- (deg) -+--- (kN) ---+--- (kN) --|
|L End | 0.50| 84.3 43.6| 112 | 6 8 110 | 23 | 367.7 | 367.7 |
|Centre| 4.30| 78.6 34.8| 330 | 15 8 330 | 22 | 133.2 | 346.8 |
|R End | 0.50| 84.3 43.6| 112 | 6 8 110 | 23 | 367.7 | 367.7 |
+-----+
|Beam: 4 |
| Seismic Shear (kN)- L End: maxVED: 92.4 minVED: -21.8 minV/maxV:-0.24|
| Seismic Shear (kN)- L End: maxVED: 92.3 minVED: -21.9 minV/maxV:-0.24|
+-----+
|Region|Length|Ties design shear|max tie|Prov. ties | strut | VR,s | VR,max |
| | |Seismic Non-Seis.|spacing| No. Φ s | angle |provided|provided|
|-----+- (m) ---+----- (kN) -----+- (mm) --+----- (mm) --+- (deg) -+--- (kN) ---+--- (kN) --|
|L End | 0.50| 86.5 45.6| 112 | 6 8 110 | 23 | 367.7 | 367.7 |
|Centre| 4.30| 80.7 36.7| 330 | 15 8 330 | 22 | 133.2 | 346.8 |
|R End | 0.50| 86.4 43.4| 112 | 6 8 110 | 23 | 367.7 | 367.7 |
+-----+
|Beam: 5 |
| Seismic Shear (kN)- L End: maxVED: 82.0 minVED: -9.5 minV/maxV:-0.12|
| Seismic Shear (kN)- L End: maxVED: 80.0 minVED: -11.5 minV/maxV:-0.14|
+-----+

```

Region	Length	Ties design shear	max tie	Prov. ties	strut	VR,s	VR,max
		Seismic Non-Seis.	spacing	No. Φ s	angle	provided	provided
-----+- (m)---+----- (kN)-----+- (mm)---+----- (mm)---+ (deg)---+ (kN)---+ (kN)---							
L End	0.50	76.2	45.9	112	6 8 110	23	367.7 367.7
Centre	4.40	70.3	37.0	330	15 8 330	22	133.2 346.8
R End	0.50	74.1	43.1	112	6 8 110	23	367.7 367.7

-----+

STOREY: 1 * BEAMS: 1 2 3 4 5

SUM OF BEAM/COLUMN DESIGN MOMENT RESISTANCES, SMRd,b/SMRd,c, AROUND JOINT
+-----+

Beam	Beam end & direction of MRd Vector:			
	Left End +y	Left End -y	Right End +y	Right End -y
+-----+----- (kNm)-----+----- (kNm)-----+----- (kNm)-----+----- (kNm)-----+*				
1	149.3 / 329.2	86.9 / 329.2	259.0 / 966.9	259.0 / 966.9
2	259.0 / 966.9	259.0 / 966.9	272.6 / 942.9	272.6 / 942.9
3	272.6 / 942.9	272.6 / 942.9	272.6 / 942.9	272.6 / 942.9
4	272.6 / 942.9	272.6 / 942.9	259.0 / 966.9	259.0 / 966.9
5	259.0 / 966.9	259.0 / 966.9	86.9 / 329.2	149.3 / 329.2

+-----+
|Beam: 1 |
| Seismic Shear (kN)- L End: maxVEd: 79.7 minVEd: -12.0 minV/maxV:-0.15|
Seismic Shear (kN)- L End: maxVEd: 82.5 minVEd: -9.2 minV/maxV:-0.11

Region	Length	Ties design shear	max tie	Prov. ties	strut	VR,s	VR,max
		Seismic Non-Seis.	spacing	No. Φ s	angle	provided	provided
-----+- (m)---+----- (kN)-----+- (mm)---+----- (mm)---+ (deg)---+ (kN)---+ (kN)---							
L End	0.50	73.8	41.0	112	6 8 110	23	367.7 367.7
Centre	4.40	70.7	39.1	330	15 8 330	22	133.2 346.8
R End	0.50	76.6	48.0	112	6 8 110	23	367.7 367.7

+-----+
|Beam: 2 |
| Seismic Shear (kN)- L End: maxVEd: 83.4 minVEd: -16.9 minV/maxV:-0.20|
Seismic Shear (kN)- L End: maxVEd: 87.4 minVEd: -12.9 minV/maxV:-0.15

Region	Length	Ties design shear	max tie	Prov. ties	strut	VR,s	VR,max
		Seismic Non-Seis.	spacing	No. Φ s	angle	provided	provided
-----+- (m)---+----- (kN)-----+- (mm)---+----- (mm)---+ (deg)---+ (kN)---+ (kN)---							
L End	0.50	77.5	44.0	112	6 8 110	23	367.7 367.7
Centre	4.30	75.7	36.1	330	15 8 330	22	133.2 346.8

R End	0.50	81.6	45.0	112	6	8	110	23	367.7	367.7
+-----+										
Beam: 3										
	Seismic Shear (kN)- L End: maxVEd: 85.9 minVEd: -16.9 minV/maxV:-0.20									
	Seismic Shear (kN)- L End: maxVEd: 85.9 minVEd: -16.9 minV/maxV:-0.20									
+-----+										
Region	Length	Ties design shear	max tie	Prov. ties	strut	VR,s	VR,max			
		Seismic Non-Seis.	spacing	No. Φ s	angle	provided	provided			
-----+	-(m)---+	----- (kN)-----+	-(mm)---+	----- (mm)---+	-(deg)---+	----- (kN)-----+	----- (kN)---			
L End	0.50	80.2	43.6	112	6	8	110	23	367.7	367.7
Centre	4.30	74.4	34.8	330	15	8	330	22	133.2	346.8
R End	0.50	80.2	43.6	112	6	8	110	23	367.7	367.7
+-----+										
Beam: 4										
	Seismic Shear (kN)- L End: maxVEd: 87.4 minVEd: -12.9 minV/maxV:-0.15									
	Seismic Shear (kN)- L End: maxVEd: 83.4 minVEd: -16.9 minV/maxV:-0.20									
+-----+										
Region	Length	Ties design shear	max tie	Prov. ties	strut	VR,s	VR,max			
		Seismic Non-Seis.	spacing	No. Φ s	angle	provided	provided			
-----+	-(m)---+	----- (kN)-----+	-(mm)---+	----- (mm)---+	-(deg)---+	----- (kN)-----+	----- (kN)---			
L End	0.50	81.6	45.0	112	6	8	110	23	367.7	367.7
Centre	4.30	75.7	36.1	330	15	8	330	22	133.2	346.8
R End	0.50	77.5	44.0	112	6	8	110	23	367.7	367.7
+-----+										
Beam: 5										
	Seismic Shear (kN)- L End: maxVEd: 82.5 minVEd: -9.2 minV/maxV:-0.11									
	Seismic Shear (kN)- L End: maxVEd: 79.7 minVEd: -12.0 minV/maxV:-0.15									
+-----+										
Region	Length	Ties design shear	max tie	Prov. ties	strut	VR,s	VR,max			
		Seismic Non-Seis.	spacing	No. Φ s	angle	provided	provided			
-----+	-(m)---+	----- (kN)-----+	-(mm)---+	----- (mm)---+	-(deg)---+	----- (kN)-----+	----- (kN)---			
L End	0.50	76.6	48.0	112	6	8	110	23	367.7	367.7
Centre	4.40	70.7	39.1	330	15	8	330	22	133.2	346.8
R End	0.50	73.8	41.0	112	6	8	110	23	367.7	367.7
+-----+										

3A 3.2. FRAME B

+-----+

SHEAR FORCES - ULS DESIGN OF TRANSVERSE REINFORCEMENT

+-----+
 * Concrete: C25 - Long. Reinforcement: S500 - Stirrups: S500 - Cover: 35 (mm) *

STOREY: 6 * BEAMS: 6 7

SUM OF BEAM/COLUMN DESIGN MOMENT RESISTANCES, SMRd,b/SMRd,c, AROUND JOINT

+-----+
 | Beam| Beam end & direction of MRd Vector: |
 | | Left End +y | Left End -y | Right End +y | Right End -y |
 +-----+----- (kNm) -----+----- (kNm) -----+----- (kNm) -----+----- (kNm) -----+

6	217.9 / 380.2	116.0 / 380.2	218.0 / 380.2	218.0 / 380.2
7	218.0 / 380.2	218.0 / 380.2	87.7 / 380.2	154.4 / 380.2

+-----+
 |Beam: 6 |
 | Seismic Shear (kN)- L End: maxVED: 148.6 minVED: 50.0 minV/maxV: 0.34 |
Seismic Shear (kN)- L End: maxVED: 90.9 minVED: -7.6 minV/maxV:-0.08

Region	Length	Ties design shear	max tie	Prov. ties	strut	VR,s	VR,max
		Seismic Non-Seis.	spacing	No. Φ s	angle	provided	provided
-----+-	(m) --+-----	(kN) -----+-	(mm) --+-----	(mm) --+-	(deg) -+--	(kN) -+--	(kN) --
L End	0.50	136.8 106.0	112	6 8 110	23	367.7	367.7
Centre	4.60	125.1 88.2	330	15 8 330	22	133.2	346.8
R End	0.50	79.2 71.9	96	7 8 95	23	389.7	389.7

+-----+
 |Beam: 7 |
 | Seismic Shear (kN)- L End: maxVED: 104.5 minVED: 20.9 minV/maxV: 0.20 |
Seismic Shear (kN)- L End: maxVED: 120.1 minVED: 36.4 minV/maxV: 0.30

Region	Length	Ties design shear	max tie	Prov. ties	strut	VR,s	VR,max
		Seismic Non-Seis.	spacing	No. Φ s	angle	provided	provided
-----+-	(m) --+-----	(kN) -----+-	(mm) --+-----	(mm) --+-	(deg) -+--	(kN) -+--	(kN) --
L End	0.50	92.8 85.0	96	7 8 95	25	389.7	389.7
Centre	4.50	96.6 75.1	330	15 8 330	22	133.2	346.8
R End	0.50	108.3 92.9	112	6 8 110	25	367.7	367.7

STOREY: 5 * BEAMS: 6 7

SUM OF BEAM/COLUMN DESIGN MOMENT RESISTANCES, SMRd,b/SMRd,c, AROUND JOINT

+-----+
 | Beam| Beam end & direction of MRd Vector: |
 +-----+

	Left End +y	Left End -y	Right End +y	Right End -y
	(kNm)	(kNm)	(kNm)	(kNm)
6	294.0 / 734.1	171.4 / 734.1	302.0 / 734.1	272.2 / 734.1
7	302.0 / 734.1	272.2 / 734.1	173.6 / 734.1	230.4 / 734.1

Beam: 6

Seismic Shear (kN)- L End: maxVED: 178.2 minVED: 46.5 minV/maxV: 0.26

Seismic Shear (kN)- L End: maxVED: 94.5 minVED: -37.2 minV/maxV:-0.39

Region	Length	Ties design shear	max tie	Prov. ties	strut	VR,s	VR,max
	(m)	(kN)	(mm)	(mm)	(deg)	(kN)	(kN)
L End	0.50	166.4 113.8	112	6 8 110	23	367.7	367.7
Centre	4.60	154.7 96.0	330	18 8 280	22	157.0	346.8
R End	0.50	82.7 64.1	112	6 8 110	23	367.7	367.7

Beam: 7

Seismic Shear (kN)- L End: maxVED: 122.7 minVED: -5.6 minV/maxV:-0.05

Seismic Shear (kN)- L End: maxVED: 146.6 minVED: 18.2 minV/maxV: 0.12

Region	Length	Ties design shear	max tie	Prov. ties	strut	VR,s	VR,max
	(m)	(kN)	(mm)	(mm)	(deg)	(kN)	(kN)
L End	0.50	111.0 79.8	112	6 8 110	23	367.7	367.7
Centre	4.50	123.1 80.3	330	15 8 330	22	133.2	346.8
R End	0.50	134.8 98.1	112	6 8 110	23	367.7	367.7

STOREY: 4 * BEAMS: 6 7

SUM OF BEAM/COLUMN DESIGN MOMENT RESISTANCES, SMRd,b/SMRd,c, AROUND JOINT

Beam	Left End +y	Left End -y	Right End +y	Right End -y
6	294.0 / 609.8	171.4 / 609.8	318.3 / 631.2	279.4 / 631.2
7	318.3 / 631.2	279.4 / 631.2	173.6 / 609.8	230.4 / 609.8

Beam: 6

Seismic Shear (kN)- L End: maxVED: 173.9 minVED: 41.0 minV/maxV: 0.24

```

|          Seismic Shear (kN)- L End: maxVEd: 100.0 minVEd: -33.0 minV/maxV:-0.33|
|-----|
|Region|Length|Ties design shear|max tie|Prov. ties | strut | VR,s | VR,max |
|      |      |Seismic Non-Seis.|spacing| No. Φ  s | angle |provided|provided|
|-----+- (m)---+----- (kN)-----+- (mm)---+----- (mm)---+ (deg)---+ (kN)---+ (kN)---|
|L End | 0.50| 162.2  110.7| 112 | 6 8 110 | 23 | 367.7 | 367.7 |
|Centre| 4.60| 150.4   92.9| 330 | 17 8 290 | 22 | 151.6 | 346.8 |
|R End | 0.50|  88.2   67.2| 112 | 6 8 110 | 23 | 367.7 | 367.7 |
+-----+
|Beam:  7 |
|          Seismic Shear (kN)- L End: maxVEd: 128.2 minVEd: -3.1 minV/maxV:-0.02|
|          Seismic Shear (kN)- L End: maxVEd: 144.1 minVEd:  12.8 minV/maxV: 0.09|
|-----|
|Region|Length|Ties design shear|max tie|Prov. ties | strut | VR,s | VR,max |
|      |      |Seismic Non-Seis.|spacing| No. Φ  s | angle |provided|provided|
|-----+- (m)---+----- (kN)-----+- (mm)---+----- (mm)---+ (deg)---+ (kN)---+ (kN)---|
|L End | 0.50| 116.4   81.6| 112 | 6 8 110 | 23 | 367.7 | 367.7 |
|Centre| 4.50| 120.6   78.5| 330 | 15 8 330 | 22 | 133.2 | 346.8 |
|R End | 0.50| 132.3   96.3| 112 | 6 8 110 | 23 | 367.7 | 367.7 |
+-----+
*-----*
| STOREY:  3 * BEAMS:  6  7 |
*-----*
| SUM OF BEAM/COLUMN DESIGN MOMENT RESISTANCES, SMRd,b/SMRd,c, AROUND JOINT |
+-----+
| Beam|          Beam end & direction of MRd Vector: |
|      | Left End  +y | Left End  -y | Right End  +y | Right End  -y |
+-----+----- (kNm)-----+----- (kNm)-----+----- (kNm)-----+----- (kNm)-----+
*-----*
|  6 | 303.4 / 595.2 | 171.4 / 595.2 | 336.2 / 633.7 | 287.4 / 633.7 |
|  7 | 336.2 / 633.7 | 287.4 / 633.7 | 173.6 / 595.2 | 230.4 / 595.2 |
+-----+
|Beam:  6 |
|          Seismic Shear (kN)- L End: maxVEd: 173.3 minVEd:  37.2 minV/maxV: 0.21|
|          Seismic Shear (kN)- L End: maxVEd: 103.8 minVEd: -32.3 minV/maxV:-0.31|
|-----|
|Region|Length|Ties design shear|max tie|Prov. ties | strut | VR,s | VR,max |
|      |      |Seismic Non-Seis.|spacing| No. Φ  s | angle |provided|provided|
|-----+- (m)---+----- (kN)-----+- (mm)---+----- (mm)---+ (deg)---+ (kN)---+ (kN)---|
|L End | 0.50| 161.5  109.0| 112 | 6 8 110 | 23 | 367.7 | 367.7 |
|Centre| 4.60| 149.8   91.2| 330 | 17 8 290 | 22 | 151.6 | 346.8 |
|R End | 0.50|  92.0   68.9| 112 | 6 8 110 | 23 | 367.7 | 367.7 |

```

```

+-----+
|Beam: 7|
|
| Seismic Shear (kN)- L End: maxVED: 132.5 minVED: -2.1 minV/maxV:-0.02|
| Seismic Shear (kN)- L End: maxVED: 143.0 minVED: 8.4 minV/maxV: 0.06|
|-----|
|Region|Length|Ties design shear|max tie|Prov. ties | strut | VR,s | VR,max |
|      |      |Seismic Non-Seis.|spacing| No. Φ  s | angle |provided|provided|
|-----+-(m)---+------(kN)-----+-(mm)---+------(mm)---+-(deg)---+-(kN)---+-(kN)---|
|L End | 0.50| 120.7 82.4| 112 | 6 8 110 | 23 | 367.7 | 367.7 |
|Centre| 4.50| 119.5 77.8| 330 | 15 8 330 | 22 | 133.2 | 346.8 |
|R End | 0.50| 131.3 95.6| 112 | 6 8 110 | 23 | 367.7 | 367.7 |
+-----+
*-----*
STOREY: 2 * BEAMS: 6 7
*-----*
SUM OF BEAM/COLUMN DESIGN MOMENT RESISTANCES, SMRd,b/SMRd,c, AROUND JOINT
+-----+
| Beam|
|      | Beam end & direction of MRd Vector:
|      | Left End +y | Left End -y | Right End +y | Right End -y |
+-----+------(kNm)-----+------(kNm)-----+------(kNm)-----+------(kNm)-----+
*-----*
| 6 | 278.7 / 704.4 | 169.1 / 704.4 | 336.2 / 739.0 | 287.4 / 739.0 |
| 7 | 336.2 / 739.0 | 287.4 / 739.0 | 173.6 / 704.4 | 230.4 / 704.4 |
+-----+
|Beam: 6|
|
| Seismic Shear (kN)- L End: maxVED: 165.4 minVED: 34.1 minV/maxV: 0.21|
| Seismic Shear (kN)- L End: maxVED: 106.8 minVED: -24.5 minV/maxV:-0.23|
|-----|
|Region|Length|Ties design shear|max tie|Prov. ties | strut | VR,s | VR,max |
|      |      |Seismic Non-Seis.|spacing| No. Φ  s | angle |provided|provided|
|-----+-(m)---+------(kN)-----+-(mm)---+------(mm)---+-(deg)---+-(kN)---+-(kN)---|
|L End | 0.50| 153.7 106.5| 112 | 6 8 110 | 23 | 367.7 | 367.7 |
|Centre| 4.60| 141.9 88.7| 330 | 16 8 310 | 22 | 141.8 | 346.8 |
|R End | 0.50| 95.1 71.4| 112 | 6 8 110 | 23 | 367.7 | 367.7 |
+-----+
|Beam: 7|
|
| Seismic Shear (kN)- L End: maxVED: 134.1 minVED: -0.5 minV/maxV: 0.00|
| Seismic Shear (kN)- L End: maxVED: 141.4 minVED: 6.8 minV/maxV: 0.05|
|-----|
|Region|Length|Ties design shear|max tie|Prov. ties | strut | VR,s | VR,max |
|      |      |Seismic Non-Seis.|spacing| No. Φ  s | angle |provided|provided|
|-----+-(m)---+------(kN)-----+-(mm)---+------(mm)---+-(deg)---+-(kN)---+-(kN)---|

```

L End	0.50	122.4	83.6	112	6 8 110	23	367.7	367.7
Centre	4.50	117.9	76.6	330	15 8 330	22	133.2	346.8
R End	0.50	129.6	94.4	112	6 8 110	23	367.7	367.7

STOREY: 1 * BEAMS: 6 7

-----*

SUM OF BEAM/COLUMN DESIGN MOMENT RESISTANCES, SMRd,b/SMRd,c, AROUND JOINT

-----+

Beam	Beam end & direction of MRd Vector:			
	Left End +y	Left End -y	Right End +y	Right End -y
+-----+	----- (kNm) -----	+----- (kNm) -----	+----- (kNm) -----	+----- (kNm) -----

-----*

6	251.9 / 749.0	133.2 / 749.0	279.4 / 781.0	279.4 / 781.0
7	279.4 / 781.0	279.4 / 781.0	117.2 / 749.0	203.3 / 749.0

-----+

|Beam: 6 |

| Seismic Shear (kN)- L End: maxVED: 154.4 minVED: 35.7 minV/maxV: 0.23|

| Seismic Shear (kN)- L End: maxVED: 105.2 minVED: -13.4 minV/maxV:-0.13|

-----|

Region	Length	Ties design shear	max tie	Prov. ties	strut	VR,s	VR,max
		Seismic Non-Seis.	spacing	No. Φ s	angle	provided	provided
-----+	+- (m) --+	----- (kN) -----	+----- (mm) --+	----- (mm) --+	+- (deg) --+	+- (kN) --+	+- (kN) --

L End	0.50	142.6	101.9	112	6 8 110	23	367.7	367.7
-------	------	-------	-------	-----	---------	----	-------	-------

Centre	4.60	130.9	84.1	330	15 8 330	22	133.2	346.8
--------	------	-------	------	-----	----------	----	-------	-------

R End	0.50	93.4	76.0	112	6 8 110	23	367.7	367.7
-------	------	------	------	-----	---------	----	-------	-------

-----+

|Beam: 7 |

| Seismic Shear (kN)- L End: maxVED: 116.8 minVED: 7.7 minV/maxV: 0.07|

| Seismic Shear (kN)- L End: maxVED: 133.2 minVED: 24.1 minV/maxV: 0.18|

-----|

Region	Length	Ties design shear	max tie	Prov. ties	strut	VR,s	VR,max
		Seismic Non-Seis.	spacing	No. Φ s	angle	provided	provided
-----+	+- (m) --+	----- (kN) -----	+----- (mm) --+	----- (mm) --+	+- (deg) --+	+- (kN) --+	+- (kN) --

L End	0.50	105.1	85.9	112	6 8 110	23	367.7	367.7
-------	------	-------	------	-----	---------	----	-------	-------

Centre	4.50	109.7	74.2	330	15 8 330	22	133.2	346.8
--------	------	-------	------	-----	----------	----	-------	-------

R End	0.50	121.4	92.0	112	6 8 110	23	367.7	367.7
-------	------	-------	------	-----	---------	----	-------	-------

-----+

-----*

STOREY: 0 * BEAMS: 6 7

-----*

SUM OF BEAM/COLUMN DESIGN MOMENT RESISTANCES, SMRd,b/SMRd,c, AROUND JOINT

```

+-----+
| Beam|          Beam end & direction of MRd Vector:          |
|      | Left End  +y | Left End  -y | Right End  +y | Right End  -y |
+-----+----- (kNm) -----+----- (kNm) -----+----- (kNm) -----+----- (kNm) -----+
*-----*
| 6 | 134.3 / 780.8 | 30.3 / 780.8 | 168.6 / 802.3 | 168.6 / 802.3 |
| 7 | 168.6 / 802.3 | 168.6 / 802.3 | 30.3 / 780.8 | 101.4 / 780.8 |
+-----+

```

```

|Beam: 6
|-----|
|Region|Length|Ties design shear|max tie|Prov. ties | strut | VR,s | VR,max |
|      |      |Seismic Non-Seis.|spacing| No. Φ  s | angle |provided|provided|
|-----+-(m)---+----- (kN) -----+-(mm)---+----- (mm)---+-(deg)---+-(kN)---+-(kN)---|
|L End | 0.50| 75.5 98.1| 330 | 3 8 330 | 22 | 133.2 | 346.8 |
|Centre| 4.60| 63.8 80.3| 330 | 15 8 330 | 22 | 133.2 | 346.8 |
|R End | 0.50| 63.4 79.8| 330 | 3 8 330 | 22 | 133.2 | 346.8 |
+-----+

```

```

|Beam: 7
|-----|
|Region|Length|Ties design shear|max tie|Prov. ties | strut | VR,s | VR,max |
|      |      |Seismic Non-Seis.|spacing| No. Φ  s | angle |provided|provided|
|-----+-(m)---+----- (kN) -----+-(mm)---+----- (mm)---+-(deg)---+-(kN)---+-(kN)---|
|L End | 0.50| 71.4 88.2| 330 | 3 8 330 | 22 | 133.2 | 346.8 |
|Centre| 4.50| 60.7 71.9| 330 | 15 8 330 | 22 | 133.2 | 346.8 |
|R End | 0.50| 72.4 89.7| 330 | 3 8 330 | 22 | 133.2 | 346.8 |
+-----+

```

```

*-----*
STOREY: -1 * BEAMS: 6 7
*-----*

```

SUM OF BEAM/COLUMN DESIGN MOMENT RESISTANCES, SMR_{d,b}/SMR_{d,c}, AROUND JOINT

```

+-----+
| Beam|          Beam end & direction of MRd Vector:          |
|      | Left End  +y | Left End  -y | Right End  +y | Right End  -y |
+-----+----- (kNm) -----+----- (kNm) -----+----- (kNm) -----+----- (kNm) -----+
*-----*
| 6 | 111.3 / 799.8 | 30.3 / 799.8 | 140.2 / 807.3 | 140.2 / 807.3 |
| 7 | 140.2 / 807.3 | 140.2 / 807.3 | 30.3 / 799.8 | 90.7 / 799.8 |
+-----+

```

```

|Beam: 6
|-----|
|Region|Length|Ties design shear|max tie|Prov. ties | strut | VR,s | VR,max |
|      |      |Seismic Non-Seis.|spacing| No. Φ  s | angle |provided|provided|

```

	(m)	(kN)	(mm)	(mm)	(deg)	(kN)	(kN)
L End	0.50	61.1	91.5	330	3 8 330	22	133.2 346.8
Centre	4.60	49.4	73.8	330	15 8 330	22	133.2 346.8
R End	0.50	57.7	86.4	330	3 8 330	22	133.2 346.8

Region	Length	Ties design	shear	max tie	Prov. ties	strut	VR,s	VR,max	
		Seismic	Non-Seis.	spacing	No. Φ	s	angle	provided	provided
L End	0.50	61.5	91.0	330	3 8 330	22	133.2	346.8	
Centre	4.50	49.7	73.2	330	15 8 330	22	133.2	346.8	
R End	0.50	58.8	86.9	330	3 8 330	22	133.2	346.8	

3A 3.3. FRAME C

SHEAR FORCES - ULS DESIGN OF TRANSVERSE REINFORCEMENT

* Concrete: C25 - Long. Reinforcement: S500 - Stirrups: S500 - Cover: 35 (mm) *

STOREY: 6 * BEAMS: 10 11 12 13 14

SUM OF BEAM/COLUMN DESIGN MOMENT RESISTANCES, SMRd,b/SMRd,c, AROUND JOINT

Beam	Beam end & direction of MRd Vector:			
	Left End +y	Left End -y	Right End +y	Right End -y
10	83.4 / 403.5	58.5 / 403.5	149.3 / 163.2	149.3 / 163.2
11	149.3 / 163.2	149.3 / 163.2	233.3 / 492.7	175.1 / 492.7
12	233.3 / 492.7	175.1 / 492.7	175.1 / 492.7	233.3 / 492.7
13	175.1 / 492.7	233.3 / 492.7	175.1 / 163.2	175.1 / 163.2
14	175.1 / 163.2	175.1 / 163.2	58.5 / 403.5	83.4 / 403.5

Beam	Seismic Shear (kN)	L End: maxVED:	minVED:	minV/maxV:
10	61.2	7.2	0.12	

Seismic Shear (kN)- L End: maxVEd: 63.3 minVEd: 9.3 minV/maxV: 0.15									
Region	Length	Ties design shear	max tie	Prov. ties	strut	VR,s	VR,max		
		Seismic Non-Seis.	spacing	No. Φ	s	angle	provided	provided	
	(m)	(kN)	(mm)	(mm)	(deg)	(kN)	(kN)		
L End	0.50	55.3	44.1	112	6 8 110	23	367.7	367.7	
Centre	4.40	51.5	35.9	330	15 8 330	22	133.2	346.8	
R End	0.50	57.4	44.8	96	7 8 95	23	389.7	389.7	
+-----+									
Beam: 11									
Seismic Shear (kN)- L End: maxVEd: 71.1 minVEd: -1.1 minV/maxV:-0.02									
Seismic Shear (kN)- L End: maxVEd: 71.6 minVEd: -0.6 minV/maxV:-0.01									
Region	Length	Ties design shear	max tie	Prov. ties	strut	VR,s	VR,max		
		Seismic Non-Seis.	spacing	No. Φ	s	angle	provided	provided	
	(m)	(kN)	(mm)	(mm)	(deg)	(kN)	(kN)		
L End	0.50	65.2	42.2	96	7 8 95	25	389.7	389.7	
Centre	4.30	59.8	37.9	330	15 8 330	22	133.2	346.8	
R End	0.50	65.7	46.8	112	6 8 110	25	367.7	367.7	
+-----+									
Beam: 12									
Seismic Shear (kN)- L End: maxVEd: 67.5 minVEd: 1.5 minV/maxV: 0.02									
Seismic Shear (kN)- L End: maxVEd: 67.5 minVEd: 1.5 minV/maxV: 0.02									
Region	Length	Ties design shear	max tie	Prov. ties	strut	VR,s	VR,max		
		Seismic Non-Seis.	spacing	No. Φ	s	angle	provided	provided	
	(m)	(kN)	(mm)	(mm)	(deg)	(kN)	(kN)		
L End	0.50	61.8	43.6	112	6 8 110	23	367.7	367.7	
Centre	4.30	56.0	34.8	330	15 8 330	22	133.2	346.8	
R End	0.50	61.8	43.6	112	6 8 110	23	367.7	367.7	
+-----+									
Beam: 13									
Seismic Shear (kN)- L End: maxVEd: 70.8 minVEd: -4.0 minV/maxV:-0.06									
Seismic Shear (kN)- L End: maxVEd: 74.5 minVEd: -0.3 minV/maxV: 0.00									
Region	Length	Ties design shear	max tie	Prov. ties	strut	VR,s	VR,max		
		Seismic Non-Seis.	spacing	No. Φ	s	angle	provided	provided	
	(m)	(kN)	(mm)	(mm)	(deg)	(kN)	(kN)		
L End	0.50	64.9	46.8	112	6 8 110	23	367.7	367.7	
Centre	4.30	62.7	37.9	330	15 8 330	22	133.2	346.8	
R End	0.50	68.6	42.2	96	7 8 95	23	389.7	389.7	
+-----+									

```

|Beam: 14
|      Seismic Shear (kN)- L End: maxVEd: 66.6 minVEd: 10.1 minV/maxV: 0.15|
|      Seismic Shear (kN)- L End: maxVEd: 60.4 minVEd: 3.9 minV/maxV: 0.06|
|-----|
|Region|Length|Ties design shear|max tie|Prov. ties | strut | VR,s | VR,max |
|      |      |Seismic Non-Seis.|spacing| No. Φ  s | angle |provided|provided|
|-----+-(m)---+----- (kN)-----+-(mm)---+----- (mm)---+-(deg)---+-(kN)---+-(kN)---|
|L End | 0.50| 60.7 44.8| 96 | 7 8 95 | 25 | 389.7 | 389.7 |
|Centre| 4.40| 54.8 35.9| 330 | 15 8 330 | 22 | 133.2 | 346.8 |
|R End | 0.50| 54.5 44.1| 112 | 6 8 110 | 25 | 367.7 | 367.7 |
+-----+
*-----*
STOREY: 5 * BEAMS: 10 11 12 13 14
*-----*
SUM OF BEAM/COLUMN DESIGN MOMENT RESISTANCES, SMRd,b/SMRd,c, AROUND JOINT
+-----+
| Beam|          Beam end & direction of MRd Vector:          |
|      | Left End +y | Left End -y | Right End +y | Right End -y |
+-----+----- (kNm)-----+----- (kNm)-----+----- (kNm)-----+----- (kNm)-----+
*-----*
| 10 | 134.6 / 810.4 | 86.9 / 810.4 | 294.4 / 333.8 | 249.6 / 333.8 |
| 11 | 294.4 / 333.8 | 249.6 / 333.8 | 272.6 / 979.0 | 272.6 / 979.0 |
| 12 | 272.6 / 979.0 | 272.6 / 979.0 | 272.6 / 979.0 | 272.6 / 979.0 |
| 13 | 272.6 / 979.0 | 272.6 / 979.0 | 249.6 / 333.8 | 294.4 / 333.8 |
| 14 | 249.6 / 333.8 | 294.4 / 333.8 | 86.9 / 810.4 | 134.6 / 810.4 |
+-----+
|Beam: 10
|      Seismic Shear (kN)- L End: maxVEd: 88.1 minVEd: 0.9 minV/maxV: 0.01|
|      Seismic Shear (kN)- L End: maxVEd: 69.6 minVEd: -17.6 minV/maxV:-0.25|
|-----|
|Region|Length|Ties design shear|max tie|Prov. ties | strut | VR,s | VR,max |
|      |      |Seismic Non-Seis.|spacing| No. Φ  s | angle |provided|provided|
|-----+-(m)---+----- (kN)-----+-(mm)---+----- (mm)---+-(deg)---+-(kN)---+-(kN)---|
|L End | 0.50| 82.2 49.0| 112 | 6 8 110 | 23 | 367.7 | 367.7 |
|Centre| 4.40| 76.4 40.0| 330 | 15 8 330 | 22 | 133.2 | 346.8 |
|R End | 0.50| 63.7 40.0| 112 | 6 8 110 | 23 | 367.7 | 367.7 |
+-----+
|Beam: 11
|      Seismic Shear (kN)- L End: maxVEd: 86.9 minVEd: -20.1 minV/maxV:-0.23|
|      Seismic Shear (kN)- L End: maxVEd: 90.6 minVEd: -16.4 minV/maxV:-0.18|
|-----|
|Region|Length|Ties design shear|max tie|Prov. ties | strut | VR,s | VR,max |

```

	Seismic	Non-Seis.	spacing	No. Φ	s	angle	provided	provided	
-----+-(m)-----	-----+(kN)-----	-----+(mm)-----	-----+(mm)-----	-----+(deg)-----	-----+(kN)-----	-----+(kN)-----			
L End	0.50	81.0	41.7	112	6 8 110	23	367.7	367.7	
Centre	4.30	78.9	38.4	330	15 8 330	22	133.2	346.8	
R End	0.50	84.7	47.3	112	6 8 110	23	367.7	367.7	
+-----+									
Beam: 12									
Seismic Shear (kN)- L End: maxVEd: 85.9 minVEd: -16.9 minV/maxV:-0.20									
Seismic Shear (kN)- L End: maxVEd: 85.9 minVEd: -16.9 minV/maxV:-0.20									
+-----+									
Region	Length	Ties design	shear	max tie	Prov. ties	strut	VR,s	VR,max	
		Seismic	Non-Seis.	spacing	No. Φ	s	angle	provided	provided
-----+-(m)-----	-----+(kN)-----	-----+(mm)-----	-----+(mm)-----	-----+(deg)-----	-----+(kN)-----	-----+(kN)-----			
L End	0.50	80.2	43.6	112	6 8 110	23	367.7	367.7	
Centre	4.30	74.4	34.8	330	15 8 330	22	133.2	346.8	
R End	0.50	80.2	43.6	112	6 8 110	23	367.7	367.7	
+-----+									
Beam: 13									
Seismic Shear (kN)- L End: maxVEd: 90.6 minVEd: -16.4 minV/maxV:-0.18									
Seismic Shear (kN)- L End: maxVEd: 86.9 minVEd: -20.1 minV/maxV:-0.23									
+-----+									
Region	Length	Ties design	shear	max tie	Prov. ties	strut	VR,s	VR,max	
		Seismic	Non-Seis.	spacing	No. Φ	s	angle	provided	provided
-----+-(m)-----	-----+(kN)-----	-----+(mm)-----	-----+(mm)-----	-----+(deg)-----	-----+(kN)-----	-----+(kN)-----			
L End	0.50	84.7	47.3	112	6 8 110	23	367.7	367.7	
Centre	4.30	78.9	38.4	330	15 8 330	22	133.2	346.8	
R End	0.50	81.0	41.7	112	6 8 110	23	367.7	367.7	
+-----+									
Beam: 14									
Seismic Shear (kN)- L End: maxVEd: 69.6 minVEd: -17.6 minV/maxV:-0.25									
Seismic Shear (kN)- L End: maxVEd: 88.1 minVEd: 0.9 minV/maxV: 0.01									
+-----+									
Region	Length	Ties design	shear	max tie	Prov. ties	strut	VR,s	VR,max	
		Seismic	Non-Seis.	spacing	No. Φ	s	angle	provided	provided
-----+-(m)-----	-----+(kN)-----	-----+(mm)-----	-----+(mm)-----	-----+(deg)-----	-----+(kN)-----	-----+(kN)-----			
L End	0.50	63.7	40.0	112	6 8 110	23	367.7	367.7	
Centre	4.40	76.4	40.0	330	15 8 330	22	133.2	346.8	
R End	0.50	82.2	49.0	112	6 8 110	23	367.7	367.7	
+-----+									

STOREY: 4 * BEAMS: 10 11 12 13 14									

SUM OF BEAM/COLUMN DESIGN MOMENT RESISTANCES, SMR_{d,b}/SMR_{d,c}, AROUND JOINT

Beam end & direction of MRd Vector:									
Beam	Left End +y		Left End -y		Right End +y		Right End -y		
	(kNm)		(kNm)		(kNm)		(kNm)		
10	134.6	510.4	86.9	510.4	294.4	547.3	249.6	547.3	
11	294.4	547.3	249.6	547.3	272.6	857.1	272.6	857.1	
12	272.6	857.1	272.6	857.1	272.6	857.1	272.6	857.1	
13	272.6	857.1	272.6	857.1	249.6	547.3	294.4	547.3	
14	249.6	547.3	294.4	547.3	86.9	510.4	134.6	510.4	
Beam: 10									
Seismic Shear (kN)- L End: maxVED: 86.7 minVED: -0.6 minV/maxV:-0.01									
Seismic Shear (kN)- L End: maxVED: 71.1 minVED: -16.2 minV/maxV:-0.23									
Region	Length	Ties design shear	max tie	Prov. ties	strut	VR,s	VR,max		
		Seismic Non-Seis.	spacing	No. Φ	s	angle	provided	provided	
	(m)	(kN)	(mm)	(mm)	(deg)	(kN)	(kN)		
L End	0.50	80.8	47.9	112	6 8 110	23	367.7	367.7	
Centre	4.40	74.9	39.0	330	15 8 330	22	133.2	346.8	
R End	0.50	65.2	41.1	112	6 8 110	23	367.7	367.7	
Beam: 11									
Seismic Shear (kN)- L End: maxVED: 87.3 minVED: -19.7 minV/maxV:-0.23									
Seismic Shear (kN)- L End: maxVED: 90.2 minVED: -16.8 minV/maxV:-0.19									
Region	Length	Ties design shear	max tie	Prov. ties	strut	VR,s	VR,max		
		Seismic Non-Seis.	spacing	No. Φ	s	angle	provided	provided	
	(m)	(kN)	(mm)	(mm)	(deg)	(kN)	(kN)		
L End	0.50	81.4	42.0	112	6 8 110	23	367.7	367.7	
Centre	4.30	78.4	38.1	330	15 8 330	22	133.2	346.8	
R End	0.50	84.3	47.0	112	6 8 110	23	367.7	367.7	
Beam: 12									
Seismic Shear (kN)- L End: maxVED: 85.9 minVED: -16.9 minV/maxV:-0.20									
Seismic Shear (kN)- L End: maxVED: 85.9 minVED: -16.9 minV/maxV:-0.20									
Region	Length	Ties design shear	max tie	Prov. ties	strut	VR,s	VR,max		
		Seismic Non-Seis.	spacing	No. Φ	s	angle	provided	provided	
	(m)	(kN)	(mm)	(mm)	(deg)	(kN)	(kN)		
L End	0.50	80.2	43.6	112	6 8 110	23	367.7	367.7	

```

|Centre| 4.30| 74.4 34.8| 330 | 15 8 330 | 22 | 133.2 | 346.8 |
|R End | 0.50| 80.2 43.6| 112 | 6 8 110 | 23 | 367.7 | 367.7 |
+-----+
|Beam: 13 |
| Seismic Shear (kN)- L End: maxVED: 90.2 minVED: -16.8 minV/maxV:-0.19|
| Seismic Shear (kN)- L End: maxVED: 87.3 minVED: -19.7 minV/maxV:-0.23|
+-----+
|Region|Length|Ties design shear|max tie|Prov. ties | strut | VR,s | VR,max |
| | |Seismic Non-Seis.|spacing| No. Φ s | angle |provided|provided|
|-----+-(m)---+------(kN)-----+-(mm)---+------(mm)---+-(deg)---+-(kN)---+-(kN)---|
|L End | 0.50| 84.3 47.0| 112 | 6 8 110 | 23 | 367.7 | 367.7 |
|Centre| 4.30| 78.4 38.1| 330 | 15 8 330 | 22 | 133.2 | 346.8 |
|R End | 0.50| 81.4 42.0| 112 | 6 8 110 | 23 | 367.7 | 367.7 |
+-----+
|Beam: 14 |
| Seismic Shear (kN)- L End: maxVED: 71.1 minVED: -16.2 minV/maxV:-0.23|
| Seismic Shear (kN)- L End: maxVED: 86.7 minVED: -0.6 minV/maxV:-0.01|
+-----+
|Region|Length|Ties design shear|max tie|Prov. ties | strut | VR,s | VR,max |
| | |Seismic Non-Seis.|spacing| No. Φ s | angle |provided|provided|
|-----+-(m)---+------(kN)-----+-(mm)---+------(mm)---+-(deg)---+-(kN)---+-(kN)---|
|L End | 0.50| 65.2 41.1| 112 | 6 8 110 | 23 | 367.7 | 367.7 |
|Centre| 4.40| 74.9 39.0| 330 | 15 8 330 | 22 | 133.2 | 346.8 |
|R End | 0.50| 80.8 47.9| 112 | 6 8 110 | 23 | 367.7 | 367.7 |
+-----+
*-----*
STOREY: 3 * BEAMS: 10 11 12 13 14
*-----*
SUM OF BEAM/COLUMN DESIGN MOMENT RESISTANCES, SMRd,b/SMRd,c, AROUND JOINT
+-----+
| Beam| Beam end & direction of MRd Vector: |
| | Left End +y | Left End -y | Right End +y | Right End -y |
+-----+------(kNm)-----+------(kNm)-----+------(kNm)-----+------(kNm)-----+
*-----*
| 10 | 134.6 / 226.5 | 86.9 / 226.5 | 315.2 / 787.4 | 259.0 / 787.4 |
| 11 | 315.2 / 787.4 | 259.0 / 787.4 | 281.7 / 771.7 | 281.7 / 771.7 |
| 12 | 281.7 / 771.7 | 281.7 / 771.7 | 281.7 / 771.7 | 281.7 / 771.7 |
| 13 | 281.7 / 771.7 | 281.7 / 771.7 | 259.0 / 787.4 | 315.2 / 787.4 |
| 14 | 259.0 / 787.4 | 315.2 / 787.4 | 86.9 / 226.5 | 134.6 / 226.5 |
+-----+
|Beam: 10 |
| Seismic Shear (kN)- L End: maxVED: 86.0 minVED: -2.9 minV/maxV:-0.03|

```

Seismic Shear (kN)- L End: maxVEd: 73.4 minVEd: -15.5 minV/maxV:-0.21									
Region	Length	Ties design shear	max tie	Prov. ties	strut	VR,s	VR,max		
		Seismic Non-Seis.	spacing	No. Φ	s	angle	provided	provided	
----	+- (m)	----- (kN)	-----+- (mm)	----- (mm)	----- (deg)	----	----	----	----
L End	0.50	80.2	47.5	112	6 8 110	23	367.7	367.7	
Centre	4.40	74.3	38.5	330	15 8 330	22	133.2	346.8	
R End	0.50	67.6	41.5	112	6 8 110	23	367.7	367.7	
+-----+									
Beam: 11									
Seismic Shear (kN)- L End: maxVEd: 91.5 minVEd: -21.1 minV/maxV:-0.23									
Seismic Shear (kN)- L End: maxVEd: 91.6 minVEd: -21.0 minV/maxV:-0.23									
Region	Length	Ties design shear	max tie	Prov. ties	strut	VR,s	VR,max		
		Seismic Non-Seis.	spacing	No. Φ	s	angle	provided	provided	
----	+- (m)	----- (kN)	-----+- (mm)	----- (mm)	----- (deg)	----	----	----	----
L End	0.50	85.6	42.2	112	6 8 110	23	367.7	367.7	
Centre	4.30	79.8	37.9	330	15 8 330	22	133.2	346.8	
R End	0.50	85.7	46.8	112	6 8 110	23	367.7	367.7	
+-----+									
Beam: 12									
Seismic Shear (kN)- L End: maxVEd: 87.7 minVEd: -18.6 minV/maxV:-0.21									
Seismic Shear (kN)- L End: maxVEd: 87.7 minVEd: -18.6 minV/maxV:-0.21									
Region	Length	Ties design shear	max tie	Prov. ties	strut	VR,s	VR,max		
		Seismic Non-Seis.	spacing	No. Φ	s	angle	provided	provided	
----	+- (m)	----- (kN)	-----+- (mm)	----- (mm)	----- (deg)	----	----	----	----
L End	0.50	81.9	43.6	112	6 8 110	23	367.7	367.7	
Centre	4.30	76.1	34.8	330	15 8 330	22	133.2	346.8	
R End	0.50	81.9	43.6	112	6 8 110	23	367.7	367.7	
+-----+									
Beam: 13									
Seismic Shear (kN)- L End: maxVEd: 91.6 minVEd: -21.0 minV/maxV:-0.23									
Seismic Shear (kN)- L End: maxVEd: 91.5 minVEd: -21.1 minV/maxV:-0.23									
Region	Length	Ties design shear	max tie	Prov. ties	strut	VR,s	VR,max		
		Seismic Non-Seis.	spacing	No. Φ	s	angle	provided	provided	
----	+- (m)	----- (kN)	-----+- (mm)	----- (mm)	----- (deg)	----	----	----	----
L End	0.50	85.7	46.8	112	6 8 110	23	367.7	367.7	
Centre	4.30	79.8	37.9	330	15 8 330	22	133.2	346.8	
R End	0.50	85.6	42.2	112	6 8 110	23	367.7	367.7	
+-----+									

```

|Beam: 14
|      Seismic Shear (kN)- L End: maxVEd:  73.4 minVEd: -15.5 minV/maxV:-0.21|
|      Seismic Shear (kN)- L End: maxVEd:  86.0 minVEd:  -2.9 minV/maxV:-0.03|
|-----|
|Region|Length|Ties design shear|max tie|Prov. ties | strut | VR,s | VR,max |
|      |      |Seismic Non-Seis.|spacing| No. Φ  s | angle |provided|provided|
|-----+-(m)---+----- (kN)-----+-(mm)---+----- (mm)---+-(deg)---+-(kN)---+-(kN)---|
|L End | 0.50| 67.6 41.5| 112 | 6 8 110 | 23 | 367.7 | 367.7 |
|Centre| 4.40| 74.3 38.5| 330 | 15 8 330 | 22 | 133.2 | 346.8 |
|R End | 0.50| 80.2 47.5| 112 | 6 8 110 | 23 | 367.7 | 367.7 |
+-----+
*-----*
STOREY: 2 * BEAMS: 10 11 12 13 14
*-----*
SUM OF BEAM/COLUMN DESIGN MOMENT RESISTANCES, SMRd,b/SMRd,c, AROUND JOINT
+-----+
| Beam|          Beam end & direction of MRd Vector:          |
|      | Left End  +y | Left End  -y | Right End  +y | Right End  -y |
+-----+----- (kNm)-----+----- (kNm)-----+----- (kNm)-----+----- (kNm)-----+
*-----*
| 10 | 134.6 / 262.3 | 86.9 / 262.3 | 281.7 / 849.5 | 258.1 / 849.5 |
| 11 | 281.7 / 849.5 | 258.1 / 849.5 | 272.6 / 827.5 | 272.6 / 827.5 |
| 12 | 272.6 / 827.5 | 272.6 / 827.5 | 272.6 / 827.5 | 272.6 / 827.5 |
| 13 | 272.6 / 827.5 | 272.6 / 827.5 | 258.1 / 849.5 | 281.7 / 849.5 |
| 14 | 258.1 / 849.5 | 281.7 / 849.5 | 86.9 / 262.3 | 134.6 / 262.3 |
+-----+
|Beam: 10
|      Seismic Shear (kN)- L End: maxVEd:  85.2 minVEd:  -3.5 minV/maxV:-0.04|
|      Seismic Shear (kN)- L End: maxVEd:  74.0 minVEd: -14.7 minV/maxV:-0.20|
|-----|
|Region|Length|Ties design shear|max tie|Prov. ties | strut | VR,s | VR,max |
|      |      |Seismic Non-Seis.|spacing| No. Φ  s | angle |provided|provided|
|-----+-(m)---+----- (kN)-----+-(mm)---+----- (mm)---+-(deg)---+-(kN)---+-(kN)---|
|L End | 0.50| 79.4 46.9| 112 | 6 8 110 | 23 | 367.7 | 367.7 |
|Centre| 4.40| 73.5 38.0| 330 | 15 8 330 | 22 | 133.2 | 346.8 |
|R End | 0.50| 68.2 42.1| 112 | 6 8 110 | 23 | 367.7 | 367.7 |
+-----+
|Beam: 11
|      Seismic Shear (kN)- L End: maxVEd:  85.6 minVEd: -19.0 minV/maxV:-0.22|
|      Seismic Shear (kN)- L End: maxVEd:  89.5 minVEd: -15.1 minV/maxV:-0.17|
|-----|
|Region|Length|Ties design shear|max tie|Prov. ties | strut | VR,s | VR,max |

```

	Seismic Non-Seis.	spacing	No. Φ	s	angle	provided	provided
-----+-(m)-----	-----+(kN)-----	-----+(mm)-----	-----+(mm)-----	-----+(deg)-----	-----+(kN)-----	-----+(kN)-----	
L End	0.50	79.7	42.5	112	6 8 110	23	367.7 367.7
Centre	4.30	77.7	37.6	330	15 8 330	22	133.2 346.8
R End	0.50	83.6	46.5	112	6 8 110	23	367.7 367.7
+-----+							
Beam: 12							
Seismic Shear (kN)- L End: maxVEd: 85.9 minVEd: -16.9 minV/maxV:-0.20							
Seismic Shear (kN)- L End: maxVEd: 85.9 minVEd: -16.9 minV/maxV:-0.20							

Region	Length	Ties design shear	max tie	Prov. ties	strut	VR,s	VR,max
	Seismic Non-Seis.	spacing	No. Φ	s	angle	provided	provided
-----+-(m)-----	-----+(kN)-----	-----+(mm)-----	-----+(mm)-----	-----+(deg)-----	-----+(kN)-----	-----+(kN)-----	
L End	0.50	80.2	43.6	112	6 8 110	23	367.7 367.7
Centre	4.30	74.4	34.8	330	15 8 330	22	133.2 346.8
R End	0.50	80.2	43.6	112	6 8 110	23	367.7 367.7
+-----+							
Beam: 13							
Seismic Shear (kN)- L End: maxVEd: 89.5 minVEd: -15.1 minV/maxV:-0.17							
Seismic Shear (kN)- L End: maxVEd: 85.6 minVEd: -19.0 minV/maxV:-0.22							

Region	Length	Ties design shear	max tie	Prov. ties	strut	VR,s	VR,max
	Seismic Non-Seis.	spacing	No. Φ	s	angle	provided	provided
-----+-(m)-----	-----+(kN)-----	-----+(mm)-----	-----+(mm)-----	-----+(deg)-----	-----+(kN)-----	-----+(kN)-----	
L End	0.50	83.6	46.5	112	6 8 110	23	367.7 367.7
Centre	4.30	77.7	37.6	330	15 8 330	22	133.2 346.8
R End	0.50	79.7	42.5	112	6 8 110	23	367.7 367.7
+-----+							
Beam: 14							
Seismic Shear (kN)- L End: maxVEd: 74.0 minVEd: -14.7 minV/maxV:-0.20							
Seismic Shear (kN)- L End: maxVEd: 85.2 minVEd: -3.5 minV/maxV:-0.04							

Region	Length	Ties design shear	max tie	Prov. ties	strut	VR,s	VR,max
	Seismic Non-Seis.	spacing	No. Φ	s	angle	provided	provided
-----+-(m)-----	-----+(kN)-----	-----+(mm)-----	-----+(mm)-----	-----+(deg)-----	-----+(kN)-----	-----+(kN)-----	
L End	0.50	68.2	42.1	112	6 8 110	23	367.7 367.7
Centre	4.40	73.5	38.0	330	15 8 330	22	133.2 346.8
R End	0.50	79.4	46.9	112	6 8 110	23	367.7 367.7
+-----+							

STOREY: 1 * BEAMS: 10 11 12 13 14							

SUM OF BEAM/COLUMN DESIGN MOMENT RESISTANCES, SMR_{d,b}/SMR_{d,c}, AROUND JOINT

+-----+-----+-----+-----+-----+-----+-----+-----+-----+-----+									
Beam									
+-----+-----+-----+-----+-----+-----+-----+-----+-----+-----+									

10									
11									
12									
13									
14									
+-----+-----+-----+-----+-----+-----+-----+-----+-----+-----+									
Beam: 10									

Region Length Ties design shear max tie Prov. ties strut VR,s VR,max									
-----+-(m)---+------(kN)-----+-(mm)---+------(mm)---+-(deg)---+-(kN)---+-(kN)---									
L End 0.50 71.8 44.8 112 6 8 110 23 367.7 367.7									
Centre 4.40 65.9 35.9 330 15 8 330 22 133.2 346.8									
R End 0.50 62.7 44.2 112 6 8 110 23 367.7 367.7									
+-----+-----+-----+-----+-----+-----+-----+-----+-----+-----+									
Beam: 11									

Region Length Ties design shear max tie Prov. ties strut VR,s VR,max									
-----+-(m)---+------(kN)-----+-(mm)---+------(mm)---+-(deg)---+-(kN)---+-(kN)---									
L End 0.50 78.8 43.1 112 6 8 110 23 367.7 367.7									
Centre 4.30 74.4 37.0 330 15 8 330 22 133.2 346.8									
R End 0.50 80.3 45.9 112 6 8 110 23 367.7 367.7									
+-----+-----+-----+-----+-----+-----+-----+-----+-----+-----+									
Beam: 12									

Region Length Ties design shear max tie Prov. ties strut VR,s VR,max									
-----+-(m)---+------(kN)-----+-(mm)---+------(mm)---+-(deg)---+-(kN)---+-(kN)---									
L End 0.50 77.6 43.6 112 6 8 110 23 367.7 367.7									

```

|Centre| 4.30| 71.9 34.8| 330 | 15 8 330 | 22 | 133.2 | 346.8 |
|R End | 0.50| 77.6 43.6| 112 | 6 8 110 | 23 | 367.7 | 367.7 |
+-----+
|Beam: 13 |
| Seismic Shear (kN)- L End: maxVED: 86.1 minVED: -14.2 minV/maxV:-0.16|
| Seismic Shear (kN)- L End: maxVED: 84.7 minVED: -15.6 minV/maxV:-0.18|
+-----+
|Region|Length|Ties design shear|max tie|Prov. ties | strut | VR,s | VR,max |
| | |Seismic Non-Seis.|spacing| No. Φ s | angle |provided|provided|
|-----+-(m)---+------(kN)-----+-(mm)---+------(mm)---+-(deg)---+-(kN)---+-(kN)---|
|L End | 0.50| 80.3 45.9| 112 | 6 8 110 | 23 | 367.7 | 367.7 |
|Centre| 4.30| 74.4 37.0| 330 | 15 8 330 | 22 | 133.2 | 346.8 |
|R End | 0.50| 78.8 43.1| 112 | 6 8 110 | 23 | 367.7 | 367.7 |
+-----+
|Beam: 14 |
| Seismic Shear (kN)- L End: maxVED: 68.6 minVED: -7.2 minV/maxV:-0.10|
| Seismic Shear (kN)- L End: maxVED: 77.7 minVED: 1.9 minV/maxV: 0.02|
+-----+
|Region|Length|Ties design shear|max tie|Prov. ties | strut | VR,s | VR,max |
| | |Seismic Non-Seis.|spacing| No. Φ s | angle |provided|provided|
|-----+-(m)---+------(kN)-----+-(mm)---+------(mm)---+-(deg)---+-(kN)---+-(kN)---|
|L End | 0.50| 62.7 44.2| 112 | 6 8 110 | 23 | 367.7 | 367.7 |
|Centre| 4.40| 65.9 35.9| 330 | 15 8 330 | 22 | 133.2 | 346.8 |
|R End | 0.50| 71.8 44.8| 112 | 6 8 110 | 23 | 367.7 | 367.7 |
+-----+
*-----*
STOREY: 0 * BEAMS: 10 11 12 13 14
*-----*
SUM OF BEAM/COLUMN DESIGN MOMENT RESISTANCES, SMRd,b/SMRd,c, AROUND JOINT
+-----+
| Beam| Beam end & direction of MRd Vector: |
| | Left End +y | Left End -y | Right End +y | Right End -y |
+-----+------(kNm)-----+------(kNm)-----+------(kNm)-----+------(kNm)-----+
*-----*
| 10 | 111.3 / 152.7 | 30.2 / 152.7 | 168.5 / 938.2 | 168.5 / 938.2 |
| 11 | 168.5 / 938.2 | 168.5 / 938.2 | 131.7 / 912.9 | 131.7 / 912.9 |
| 12 | 131.7 / 912.9 | 131.7 / 912.9 | 131.7 / 912.9 | 131.7 / 912.9 |
| 13 | 131.7 / 912.9 | 131.7 / 912.9 | 168.5 / 938.2 | 168.5 / 938.2 |
| 14 | 168.5 / 938.2 | 168.5 / 938.2 | 30.2 / 152.7 | 111.3 / 152.7 |
+-----+
|Beam: 10 |
+-----+

```

Region	Length	Ties design shear	max tie	Prov. ties	strut	VR,s	VR,max
		Seismic Non-Seis.	spacing	No. Φ	s	angle	provided provided
-----+- (m)-----	----- (kN)-----	-----+- (mm)-----	----- (mm)-----	----- (deg)-----	----- (kN)-----	----- (kN)-----	
L End	0.50	70.2	92.8	330	3 8 330	22	133.2 346.8
Centre	4.40	58.4	75.0	330	15 8 330	22	133.2 346.8
R End	0.50	65.1	85.1	330	3 8 330	22	133.2 346.8

-----+
|Beam: 11 |

Region	Length	Ties design shear	max tie	Prov. ties	strut	VR,s	VR,max
		Seismic Non-Seis.	spacing	No. Φ	s	angle	provided provided
-----+- (m)-----	----- (kN)-----	-----+- (mm)-----	----- (mm)-----	----- (deg)-----	----- (kN)-----	----- (kN)-----	
L End	0.50	70.5	87.6	330	3 8 330	22	133.2 346.8
Centre	4.30	60.6	72.5	330	15 8 330	22	133.2 346.8
R End	0.50	72.3	90.3	330	3 8 330	22	133.2 346.8

-----+
|Beam: 12 |

Region	Length	Ties design shear	max tie	Prov. ties	strut	VR,s	VR,max
		Seismic Non-Seis.	spacing	No. Φ	s	angle	provided provided
-----+- (m)-----	----- (kN)-----	-----+- (mm)-----	----- (mm)-----	----- (deg)-----	----- (kN)-----	----- (kN)-----	
L End	0.50	72.0	89.9	330	3 8 330	22	133.2 346.8
Centre	4.30	60.1	71.9	330	15 8 330	22	133.2 346.8
R End	0.50	72.0	89.9	330	3 8 330	22	133.2 346.8

-----+
|Beam: 13 |

Region	Length	Ties design shear	max tie	Prov. ties	strut	VR,s	VR,max
		Seismic Non-Seis.	spacing	No. Φ	s	angle	provided provided
-----+- (m)-----	----- (kN)-----	-----+- (mm)-----	----- (mm)-----	----- (deg)-----	----- (kN)-----	----- (kN)-----	
L End	0.50	72.3	90.3	330	3 8 330	22	133.2 346.8
Centre	4.30	60.6	72.5	330	15 8 330	22	133.2 346.8
R End	0.50	70.5	87.6	330	3 8 330	22	133.2 346.8

-----+
|Beam: 14 |

Region	Length	Ties design shear	max tie	Prov. ties	strut	VR,s	VR,max
		Seismic Non-Seis.	spacing	No. Φ	s	angle	provided provided
-----+- (m)-----	----- (kN)-----	-----+- (mm)-----	----- (mm)-----	----- (deg)-----	----- (kN)-----	----- (kN)-----	
L End	0.50	65.1	85.1	330	3 8 330	22	133.2 346.8
Centre	4.40	58.4	75.0	330	15 8 330	22	133.2 346.8
R End	0.50	70.2	92.8	330	3 8 330	22	133.2 346.8

```

+-----+
*-----*
STOREY: -1 * BEAMS: 10 11 12 13 14
*-----*

```

SUM OF BEAM/COLUMN DESIGN MOMENT RESISTANCES, SMRd,b/SMRd,c, AROUND JOINT

```

+-----+
| Beam|          Beam end & direction of MRd Vector:          |
|      | Left End  +y | Left End  -y | Right End  +y | Right End  -y |
+-----+-----+-----+-----+-----+-----+
|      | (kNm)      | (kNm)      | (kNm)      | (kNm)      |
*-----*
| 10 | 101.4 /   0.0 | 30.2 /   0.0 | 131.7 / 964.6 | 131.7 / 964.6 |
| 11 | 131.7 / 964.6 | 131.7 / 964.6 | 131.7 / 942.3 | 131.7 / 942.3 |
| 12 | 131.7 / 942.3 | 131.7 / 942.3 | 131.7 / 942.3 | 131.7 / 942.3 |
| 13 | 131.7 / 942.3 | 131.7 / 942.3 | 131.7 / 964.6 | 131.7 / 964.6 |
| 14 | 131.7 / 964.6 | 131.7 / 964.6 | 30.2 /   0.0 | 101.4 /   0.0 |
+-----+

```

```

|Beam: 10
|-----|
|Region|Length|Ties design shear|max tie|Prov. ties | strut | VR,s | VR,max |
|      |      | |Seismic Non-Seis.|spacing| No. Φ  s | angle |provided|provided|
|-----+-(m)---+-----+-(mm)---+-----+-(mm)---+-(deg)---+-(kN)---+-(kN)---|
|L End | 0.50| 59.5 89.5| 330 | 3 8 330 | 22 | 133.2 | 346.8 |
|Centre| 4.40| 47.7 71.7| 330 | 15 8 330 | 22 | 133.2 | 346.8 |
|R End | 0.50| 58.7 88.4| 330 | 3 8 330 | 22 | 133.2 | 346.8 |
+-----+

```

```

|Beam: 11
|-----|
|Region|Length|Ties design shear|max tie|Prov. ties | strut | VR,s | VR,max |
|      |      | |Seismic Non-Seis.|spacing| No. Φ  s | angle |provided|provided|
|-----+-(m)---+-----+-(mm)---+-----+-(mm)---+-(deg)---+-(kN)---+-(kN)---|
|L End | 0.50| 59.5 88.4| 330 | 3 8 330 | 22 | 133.2 | 346.8 |
|Centre| 4.30| 48.5 71.7| 330 | 15 8 330 | 22 | 133.2 | 346.8 |
|R End | 0.50| 60.2 89.5| 330 | 3 8 330 | 22 | 133.2 | 346.8 |
+-----+

```

```

|Beam: 12
|-----|
|Region|Length|Ties design shear|max tie|Prov. ties | strut | VR,s | VR,max |
|      |      | |Seismic Non-Seis.|spacing| No. Φ  s | angle |provided|provided|
|-----+-(m)---+-----+-(mm)---+-----+-(mm)---+-(deg)---+-(kN)---+-(kN)---|
|L End | 0.50| 60.3 89.9| 330 | 3 8 330 | 22 | 133.2 | 346.8 |
|Centre| 4.30| 48.4 71.9| 330 | 15 8 330 | 22 | 133.2 | 346.8 |
|R End | 0.50| 60.3 89.9| 330 | 3 8 330 | 22 | 133.2 | 346.8 |
+-----+

```

+-----+-----+-----+-----+-----+-----+-----+-----+-----+-----+-----+										
Beam: 13										
+-----+-----+-----+-----+-----+-----+-----+-----+-----+-----+-----+										
Region	Length	Ties design shear	max tie	Prov. ties	strut	VR,s	VR,max			
		Seismic Non-Seis.	spacing	No. Φ	s	angle	provided	provided		
-----+- (m)-----	-----+ (kN)-----	-----+- (mm)-----	-----+ (mm)-----	-----+ (deg)-----	-----+ (kN)-----	-----+ (kN)-----				
L End	0.50	60.2	89.5	330	3 8 330	22	133.2	346.8		
Centre	4.30	48.5	71.7	330	15 8 330	22	133.2	346.8		
R End	0.50	59.5	88.4	330	3 8 330	22	133.2	346.8		
+-----+-----+-----+-----+-----+-----+-----+-----+-----+-----+-----+										
Beam: 14										
+-----+-----+-----+-----+-----+-----+-----+-----+-----+-----+-----+										
Region	Length	Ties design shear	max tie	Prov. ties	strut	VR,s	VR,max			
		Seismic Non-Seis.	spacing	No. Φ	s	angle	provided	provided		
-----+- (m)-----	-----+ (kN)-----	-----+- (mm)-----	-----+ (mm)-----	-----+ (deg)-----	-----+ (kN)-----	-----+ (kN)-----				
L End	0.50	58.7	88.4	330	3 8 330	22	133.2	346.8		
Centre	4.40	47.7	71.7	330	15 8 330	22	133.2	346.8		
R End	0.50	59.5	89.5	330	3 8 330	22	133.2	346.8		
+-----+-----+-----+-----+-----+-----+-----+-----+-----+-----+-----+										

3A 3.4. FRAME 1

+-----+-----+-----+-----+-----+-----+-----+-----+-----+-----+-----+										
SHEAR FORCES - ULS DESIGN OF TRANSVERSE REINFORCEMENT										
+-----+-----+-----+-----+-----+-----+-----+-----+-----+-----+-----+										
* Concrete: C25 - Long. Reinforcement: S500 - Stirrups: S500 - Cover: 35 (mm) *										
-----+-----+-----+-----+-----+-----+-----+-----+-----+-----+-----										
STOREY: 6 * BEAMS: 22 21										
-----+-----+-----+-----+-----+-----+-----+-----+-----+-----+-----										
SUM OF BEAM/COLUMN DESIGN MOMENT RESISTANCES, SMRd,b/SMRd,c, AROUND JOINT										
+-----+-----+-----+-----+-----+-----+-----+-----+-----+-----+-----+										
Beam	Beam end & direction of MRd Vector:									
	Left End	+y	Left End	-y	Right End	+y	Right End	-y		
-----+-----	-----+-----	-----+-----	-----+-----	-----+-----	-----+-----	-----+-----	-----+-----	-----+-----		
(kNm)	(kNm)	(kNm)	(kNm)	(kNm)	(kNm)	(kNm)	(kNm)	(kNm)		
-----+-----+-----+-----+-----+-----+-----+-----+-----+-----+-----										
22	188.3 /	369.5	170.8 /	369.5	419.6 /	277.2	419.6 /	277.2		
21	419.6 /	277.2	419.6 /	277.2	170.8 /	403.5	188.3 /	403.5		
+-----+-----+-----+-----+-----+-----+-----+-----+-----+-----+-----+										
Beam: 22										
+-----+-----+-----+-----+-----+-----+-----+-----+-----+-----+-----+										
Seismic Shear (kN) - L End: maxVEd: 91.4 minVEd: -45.5 minV/maxV:-0.50										

Seismic Shear (kN)- L End: maxVEd: 112.6 minVEd: -24.3 minV/maxV:-0.22
Region
-----+- (m)---+----- (kN)-----+- (mm)---+----- (mm)---+ (deg)---+ (kN)---+ (kN)---
L End
Centre
R End

Beam: 21

Seismic Shear (kN)- L End: maxVEd: 110.6 minVEd: -26.2 minV/maxV:-0.24|
 Seismic Shear (kN)- L End: maxVEd: 93.3 minVEd: -43.6 minV/maxV:-0.47|

|-----|
 |Region|Length|Ties design shear|max tie|Prov. ties | strut | VR,s | VR,max |
 | | |Seismic Non-Seis.|spacing| No. Φ s | angle |provided|provided|
 |-----+- (m)---+----- (kN)-----+- (mm)---+----- (mm)---+ (deg)---+ (kN)---+ (kN)---|
L End	0.50	103.9 44.7	96	7 8 95	25	389.7	389.7
Centre	3.65	97.2 34.6	330	13 8 330	22	133.2	346.8
R End	0.50	86.6 36.6	112	6 8 110	25	367.7	367.7

STOREY: 5 * BEAMS: 22 21

SUM OF BEAM/COLUMN DESIGN MOMENT RESISTANCES, $SMR_{d,b}/SMR_{d,c}$, AROUND JOINT

Beam | Beam end & direction of MRd Vector: |
 | Left End +y | Left End -y | Right End +y | Right End -y |
 +-----+----- (kNm)-----+----- (kNm)-----+----- (kNm)-----+----- (kNm)-----+

 | 22 | 232.7 / 768.6 | 223.2 / 768.6 | 492.8 / 633.7 | 492.8 / 633.7 |
 | 21 | 492.8 / 633.7 | 492.8 / 633.7 | 223.2 / 810.4 | 232.7 / 810.4 |

Beam: 22

Seismic Shear (kN)- L End: maxVEd: 128.1 minVEd: -75.9 minV/maxV:-0.59|
 Seismic Shear (kN)- L End: maxVEd: 143.0 minVEd: -61.0 minV/maxV:-0.43|

|-----|
 |Region|Length|Ties design shear|max tie|Prov. ties | strut | VR,s | VR,max |
 | | |Seismic Non-Seis.|spacing| No. Φ s | angle |provided|provided|
 |-----+- (m)---+----- (kN)-----+- (mm)---+----- (mm)---+ (deg)---+ (kN)---+ (kN)---|
L End	0.50	121.4 37.0	96	7 8 95	25	389.7	389.7
Centre	3.65	129.6 34.2	330	13 8 330	22	133.2	346.8
R End	0.50	136.3 44.3	112	6 8 110	25	367.7	367.7

```

+-----+
|Beam: 21|
|
|      Seismic Shear (kN)- L End: maxVED: 141.3 minVED: -62.7 minV/maxV:-0.44|
|      Seismic Shear (kN)- L End: maxVED: 129.8 minVED: -74.2 minV/maxV:-0.57|
|-----|
|Region|Length|Ties design shear|max tie|Prov. ties | strut | VR,s | VR,max |
|      |      |Seismic Non-Seis.|spacing| No. Φ  s | angle |provided|provided|
|-----+- (m)---+----- (kN)-----+- (mm)---+----- (mm)---+- (deg)---+--- (kN)---+--- (kN)---|
|L End | 0.50| 134.6  42.8| 112 | 6 8 110 | 23 | 367.7 | 367.7 |
|Centre| 3.65| 127.9  32.6| 330 | 13 8 330 | 22 | 133.2 | 346.8 |
|R End | 0.50| 123.1  38.5| 96 | 7 8 95 | 23 | 389.7 | 389.7 |
+-----+

```

```

*-----*
STOREY: 4 * BEAMS: 22 21
*-----*

```

```

SUM OF BEAM/COLUMN DESIGN MOMENT RESISTANCES, SMRd,b/SMRd,c, AROUND JOINT
+-----+
| Beam|
|      |      |      |      |      |      |      |      |
|      | Left End +y | Left End -y | Right End +y | Right End -y |
+-----+----- (kNm)-----+----- (kNm)-----+----- (kNm)-----+----- (kNm)-----+
*-----*
| 22 | 232.7 / 823.9 | 223.2 / 823.9 | 492.8 / 739.0 | 492.8 / 739.0 |
| 21 | 492.8 / 739.0 | 492.8 / 739.0 | 223.2 / 777.3 | 232.7 / 777.3 |
+-----+

```

```

|Beam: 22|
|
|      Seismic Shear (kN)- L End: maxVED: 127.9 minVED: -76.2 minV/maxV:-0.60|
|      Seismic Shear (kN)- L End: maxVED: 143.3 minVED: -60.8 minV/maxV:-0.42|
|-----|
|Region|Length|Ties design shear|max tie|Prov. ties | strut | VR,s | VR,max |
|      |      |Seismic Non-Seis.|spacing| No. Φ  s | angle |provided|provided|
|-----+- (m)---+----- (kN)-----+- (mm)---+----- (mm)---+- (deg)---+--- (kN)---+--- (kN)---|
|L End | 0.50| 121.2  36.9| 96 | 7 8 95 | 25 | 389.7 | 389.7 |
|Centre| 3.65| 129.8  34.2| 330 | 13 8 330 | 22 | 133.2 | 346.8 |
|R End | 0.50| 136.5  44.4| 112 | 6 8 110 | 25 | 367.7 | 367.7 |
+-----+

```

```

|Beam: 21|
|
|      Seismic Shear (kN)- L End: maxVED: 141.3 minVED: -62.8 minV/maxV:-0.44|
|      Seismic Shear (kN)- L End: maxVED: 129.9 minVED: -74.2 minV/maxV:-0.57|
|-----|
|Region|Length|Ties design shear|max tie|Prov. ties | strut | VR,s | VR,max |
|      |      |Seismic Non-Seis.|spacing| No. Φ  s | angle |provided|provided|
|-----+- (m)---+----- (kN)-----+- (mm)---+----- (mm)---+- (deg)---+--- (kN)---+--- (kN)---|

```

L End	0.50	134.5	42.9	112	6 8 110	23	367.7	367.7
Centre	3.65	127.8	32.8	330	13 8 330	22	133.2	346.8
R End	0.50	123.2	38.4	112	6 8 110	23	367.7	367.7

STOREY: 3 * BEAMS: 22 21

-----*

SUM OF BEAM/COLUMN DESIGN MOMENT RESISTANCES, SMR_{d,b}/SMR_{d,c}, AROUND JOINT

-----+

Beam	Beam end & direction of MRd Vector:			
	Left End +y	Left End -y	Right End +y	Right End -y
	(kNm)			

-----*

22	232.7 / 870.8	223.2 / 870.8	426.1 / 781.0	426.1 / 781.0
21	426.1 / 781.0	426.1 / 781.0	170.8 / 771.8	236.2 / 771.8

-----+

|Beam: 22

| Seismic Shear (kN)- L End: maxVED: 116.7 minVED: -73.0 minV/maxV:-0.63|

| Seismic Shear (kN)- L End: maxVED: 140.1 minVED: -49.6 minV/maxV:-0.35|

-----|

Region	Length	Ties design shear	max tie	Prov. ties	strut	VR,s	VR,max	
		Seismic Non-Seis.	spacing	No. Φ	s	angle	provided	provided
	(m)	(kN)	(mm)	(mm)	(deg)	(kN)	(kN)	

L End	0.50	110.0	37.4	112	6 8 110	23	367.7	367.7
-------	------	-------	------	-----	---------	----	-------	-------

Centre	3.65	126.6	33.7	330	13 8 330	22	133.2	346.8
--------	------	-------	------	-----	----------	----	-------	-------

R End	0.50	133.3	43.9	112	6 8 110	23	367.7	367.7
-------	------	-------	------	-----	---------	----	-------	-------

-----+

|Beam: 21

| Seismic Shear (kN)- L End: maxVED: 127.0 minVED: -52.2 minV/maxV:-0.41|

| Seismic Shear (kN)- L End: maxVED: 119.3 minVED: -59.9 minV/maxV:-0.50|

-----|

Region	Length	Ties design shear	max tie	Prov. ties	strut	VR,s	VR,max	
		Seismic Non-Seis.	spacing	No. Φ	s	angle	provided	provided
	(m)	(kN)	(mm)	(mm)	(deg)	(kN)	(kN)	

L End	0.50	120.3	42.6	112	6 8 110	23	367.7	367.7
-------	------	-------	------	-----	---------	----	-------	-------

Centre	3.65	113.6	32.4	330	13 8 330	22	133.2	346.8
--------	------	-------	------	-----	----------	----	-------	-------

R End	0.50	112.6	38.7	112	6 8 110	23	367.7	367.7
-------	------	-------	------	-----	---------	----	-------	-------

-----+

-----*

STOREY: 2 * BEAMS: 22 21

-----*

SUM OF BEAM/COLUMN DESIGN MOMENT RESISTANCES, SMR_{d,b}/SMR_{d,c}, AROUND JOINT

```

+-----+
| Beam|          Beam end & direction of MRd Vector:          |
|      | Left End  +y | Left End  -y | Right End  +y | Right End  -y |
+-----+----- (kNm)-----+----- (kNm)-----+----- (kNm)-----+----- (kNm) -----+
*-----*
| 22 | 204.1 / 908.6 | 170.8 / 908.6 | 394.7 / 802.3 | 394.7 / 802.3 |
| 21 | 394.7 / 802.3 | 394.7 / 802.3 | 170.8 / 829.0 | 204.1 / 829.0 |
+-----+

|Beam: 22          |
|      Seismic Shear (kN)- L End: maxVEd: 111.6 minVEd: -53.9 minV/maxV:-0.48|
|      Seismic Shear (kN)- L End: maxVEd: 121.0 minVEd: -44.5 minV/maxV:-0.37|
|-----|

|Region|Length|Ties design shear|max tie|Prov. ties | strut | VR,s | VR,max |
|      |      |Seismic Non-Seis.|spacing| No. Φ  s | angle |provided|provided|
|-----+-(m)---+----- (kN)-----+-(mm)---+----- (mm)---+(deg)---+(kN)---+(kN)---|
|L End | 0.50| 104.9  38.2| 96 | 7 8 95 | 25 | 389.7 | 389.7 |
|Centre| 3.65| 107.6  33.0| 330 | 13 8 330 | 22 | 133.2 | 346.8 |
|R End | 0.50| 114.3  43.1| 112 | 6 8 110 | 25 | 367.7 | 367.7 |
+-----+

|Beam: 21          |
|      Seismic Shear (kN)- L End: maxVEd: 119.6 minVEd: -46.0 minV/maxV:-0.38|
|      Seismic Shear (kN)- L End: maxVEd: 113.1 minVEd: -52.5 minV/maxV:-0.46|
|-----|

|Region|Length|Ties design shear|max tie|Prov. ties | strut | VR,s | VR,max |
|      |      |Seismic Non-Seis.|spacing| No. Φ  s | angle |provided|provided|
|-----+-(m)---+----- (kN)-----+-(mm)---+----- (mm)---+(deg)---+(kN)---+(kN)---|
|L End | 0.50| 112.9  42.1| 112 | 6 8 110 | 23 | 367.7 | 367.7 |
|Centre| 3.65| 106.1  31.9| 330 | 13 8 330 | 22 | 133.2 | 346.8 |
|R End | 0.50| 106.3  39.2| 96 | 7 8 95 | 23 | 389.7 | 389.7 |
+-----+
*-----*

STOREY: 1 * BEAMS: 22 21
*-----*

SUM OF BEAM/COLUMN DESIGN MOMENT RESISTANCES, SMRd,b/SMRd,c, AROUND JOINT
+-----+
| Beam|          Beam end & direction of MRd Vector:          |
|      | Left End  +y | Left End  -y | Right End  +y | Right End  -y |
+-----+----- (kNm)-----+----- (kNm)-----+----- (kNm)-----+----- (kNm) -----+
*-----*
| 22 | 158.0 / 936.8 | 116.0 / 936.8 | 294.7 / 807.3 | 294.7 / 807.3 |
| 21 | 294.7 / 807.3 | 294.7 / 807.3 | 116.0 / 877.3 | 158.0 / 877.3 |
+-----+

```

Beam: 22													
Seismic Shear (kN)- L End: maxVED: 89.8 minVED: -32.5 minV/maxV:-0.36													
Seismic Shear (kN)- L End: maxVED: 99.6 minVED: -22.7 minV/maxV:-0.23													
+-----+-----+-----+-----+-----+-----+-----+-----+-----+-----+													
Region	Length	Ties design shear	max tie	Prov. ties	strut	VR,s	VR,max						
		Seismic Non-Seis.	spacing	No. Φ	s	angle	provided	provided					
-----	+- (m)	-----	(kN)	-----	+- (mm)	-----	(mm)	-----	+- (deg)	-----	+- (kN)	-----	+- (kN)
L End	0.50	83.1	38.4	112	6	8	110	23		367.7		367.7	
Centre	3.65	86.2	32.7	330	13	8	330	22		133.2		346.8	
R End	0.50	92.9	42.9	96	7	8	95	23		389.7		389.7	
+-----+-----+-----+-----+-----+-----+-----+-----+-----+-----+													
Beam: 21													
Seismic Shear (kN)- L End: maxVED: 98.6 minVED: -23.7 minV/maxV:-0.24													
Seismic Shear (kN)- L End: maxVED: 90.8 minVED: -31.5 minV/maxV:-0.35													
+-----+-----+-----+-----+-----+-----+-----+-----+-----+-----+													
Region	Length	Ties design shear	max tie	Prov. ties	strut	VR,s	VR,max						
		Seismic Non-Seis.	spacing	No. Φ	s	angle	provided	provided					
-----	+- (m)	-----	(kN)	-----	+- (mm)	-----	(mm)	-----	+- (deg)	-----	+- (kN)	-----	+- (kN)
L End	0.50	91.9	42.1	96	7	8	95	25		389.7		389.7	
Centre	3.65	85.2	32.0	330	13	8	330	22		133.2		346.8	
R End	0.50	84.1	39.2	112	6	8	110	25		367.7		367.7	
+-----+-----+-----+-----+-----+-----+-----+-----+-----+-----+													

3A 3.5. FRAME 2

+-----+-----+-----+-----+-----+-----+-----+-----+-----+-----+												
SHEAR FORCES - ULS DESIGN OF TRANSVERSE REINFORCEMENT												
+-----+-----+-----+-----+-----+-----+-----+-----+-----+-----+												
* Concrete: C25 - Long. Reinforcement: S500 - Stirrups: S500 - Cover: 35 (mm) *												
-----+-----+-----+-----+-----+-----+-----+-----+-----+-----												
STOREY: 6 * BEAMS: 28 27												
-----+-----+-----+-----+-----+-----+-----+-----+-----+-----												
SUM OF BEAM/COLUMN DESIGN MOMENT RESISTANCES, SMRd,b/SMRd,c, AROUND JOINT												
+-----+-----+-----+-----+-----+-----+-----+-----+-----+-----+												
Beam	Beam end & direction of MRd Vector:											
	Left End	+y	Left End	-y	Right End	+y	Right End	-y				
-----	-----	-----	-----	-----	-----	-----	-----	-----	-----	-----		
-----	-----	-----	-----	-----	-----	-----	-----	-----	-----	-----		
28	126.8	/	107.8	59.0	/	107.8	302.2	/	380.2	302.2	/	380.2
27	302.2	/	380.2	302.2	/	380.2	59.0	/	380.2	108.3	/	380.2
-----+-----+-----+-----+-----+-----+-----+-----+-----+-----												

```

+-----+
|Beam: 28|
|
|      Seismic Shear (kN)- L End: maxVED: 112.2 minVED: 41.1 minV/maxV: 0.37|
|      Seismic Shear (kN)- L End: maxVED: 146.8 minVED: 75.8 minV/maxV: 0.52|
|-----|
|Region|Length|Ties design shear|max tie|Prov. ties | strut | VR,s | VR,max |
|      |      |Seismic Non-Seis.|spacing| No. Φ  s | angle |provided|provided|
|-----+- (m)---+----- (kN)-----+- (mm)---+----- (mm)---+ (deg)---+ (kN)---+ (kN)---|
|L End | 0.50| 98.7 110.2| 112 | 6 8 110 | 23 | 367.7 | 367.7 |
|Centre| 5.60| 120.0 113.4| 330 | 18 8 330 | 22 | 133.2 | 346.8 |
|R End | 0.50| 133.4 133.8| 96 | 7 8 95 | 23 | 389.7 | 389.7 |
+-----+

```

```

+-----+
|Beam: 27|
|
|      Seismic Shear (kN)- L End: maxVED: 148.6 minVED: 77.5 minV/maxV: 0.52|
|      Seismic Shear (kN)- L End: maxVED: 110.5 minVED: 39.3 minV/maxV: 0.36|
|-----|
|Region|Length|Ties design shear|max tie|Prov. ties | strut | VR,s | VR,max |
|      |      |Seismic Non-Seis.|spacing| No. Φ  s | angle |provided|provided|
|-----+- (m)---+----- (kN)-----+- (mm)---+----- (mm)---+ (deg)---+ (kN)---+ (kN)---|
|L End | 0.50| 135.2 135.0| 96 | 7 8 95 | 25 | 389.7 | 389.7 |
|Centre| 5.60| 121.8 114.7| 330 | 18 8 330 | 22 | 133.2 | 346.8 |
|R End | 0.50| 97.0 109.0| 112 | 6 8 110 | 25 | 367.7 | 367.7 |
+-----+

```

```

*-----*
STOREY: 5 * BEAMS: 28 27
*-----*

```

SUM OF BEAM/COLUMN DESIGN MOMENT RESISTANCES, SMR_{d,b}/SMR_{d,c}, AROUND JOINT

```

+-----+
| Beam|          Beam end & direction of MRd Vector:          |
|      | Left End  +y | Left End  -y | Right End  +y | Right End  -y |
|-----+----- (kNm)-----+----- (kNm)-----+----- (kNm)-----+----- (kNm)-----+
*-----*
| 28 | 187.6 / 237.4 | 116.4 / 237.4 | 327.4 / 734.1 | 327.4 / 734.1 |
| 27 | 327.4 / 734.1 | 327.4 / 734.1 | 116.4 / 734.1 | 187.6 / 734.1 |
+-----+

```

```

+-----+
|Beam: 28|
|
|      Seismic Shear (kN)- L End: maxVED: 138.3 minVED: 42.6 minV/maxV: 0.31|
|      Seismic Shear (kN)- L End: maxVED: 145.3 minVED: 49.6 minV/maxV: 0.34|
|-----|
|Region|Length|Ties design shear|max tie|Prov. ties | strut | VR,s | VR,max |
|      |      |Seismic Non-Seis.|spacing| No. Φ  s | angle |provided|provided|
|-----+- (m)---+----- (kN)-----+- (mm)---+----- (mm)---+ (deg)---+ (kN)---+ (kN)---|

```

```

|L End | 0.50| 124.9 120.6| 96 | 7 8 95 | 25 | 389.7 | 389.7 |
|Centre| 5.60| 118.5 103.1| 330 | 18 8 330 | 22 | 133.2 | 346.8 |
|R End | 0.50| 131.9 123.5| 112 | 6 8 110 | 25 | 367.7 | 367.7 |
+-----+
|Beam: 27 |
| Seismic Shear (kN)- L End: maxVED: 148.1 minVED: 52.4 minV/maxV: 0.35|
| Seismic Shear (kN)- L End: maxVED: 135.5 minVED: 39.9 minV/maxV: 0.29|
+-----+
|Region|Length|Ties design shear|max tie|Prov. ties | strut | VR,s | VR,max |
| | |Seismic Non-Seis.|spacing| No. Φ s | angle |provided|provided|
|-----+-(m)---+------(kN)-----+-(mm)---+------(mm)---+-(deg)---+-(kN)---+-(kN)---|
|L End | 0.50| 134.6 125.5| 112 | 6 8 110 | 23 | 367.7 | 367.7 |
|Centre| 5.60| 121.2 105.1| 330 | 18 8 330 | 22 | 133.2 | 346.8 |
|R End | 0.50| 122.1 118.6| 96 | 7 8 95 | 23 | 389.7 | 389.7 |
+-----+
*-----*
STOREY: 4 * BEAMS: 28 27
*-----*
SUM OF BEAM/COLUMN DESIGN MOMENT RESISTANCES, SMRd,b/SMRd,c, AROUND JOINT
+-----+
| Beam| Beam end & direction of MRd Vector: |
| | Left End +y | Left End -y | Right End +y | Right End -y |
+-----+------(kNm)-----+------(kNm)-----+------(kNm)-----+------(kNm)-----+
*-----*
| 28 | 187.6 / 276.5 | 116.4 / 276.5 | 327.4 / 631.2 | 327.4 / 631.2 |
| 27 | 327.4 / 631.2 | 327.4 / 631.2 | 116.4 / 631.2 | 186.0 / 631.2 |
+-----+
|Beam: 28 |
| Seismic Shear (kN)- L End: maxVED: 135.9 minVED: 40.2 minV/maxV: 0.30|
| Seismic Shear (kN)- L End: maxVED: 147.7 minVED: 52.0 minV/maxV: 0.35|
+-----+
|Region|Length|Ties design shear|max tie|Prov. ties | strut | VR,s | VR,max |
| | |Seismic Non-Seis.|spacing| No. Φ s | angle |provided|provided|
|-----+-(m)---+------(kN)-----+-(mm)---+------(mm)---+-(deg)---+-(kN)---+-(kN)---|
|L End | 0.50| 122.5 118.8| 96 | 7 8 95 | 25 | 389.7 | 389.7 |
|Centre| 5.60| 120.9 104.9| 330 | 18 8 330 | 22 | 133.2 | 346.8 |
|R End | 0.50| 134.3 125.2| 112 | 6 8 110 | 25 | 367.7 | 367.7 |
+-----+
|Beam: 27 |
| Seismic Shear (kN)- L End: maxVED: 150.2 minVED: 54.8 minV/maxV: 0.36|
| Seismic Shear (kN)- L End: maxVED: 133.1 minVED: 37.7 minV/maxV: 0.28|
+-----+

```

Region	Length	Ties design shear	max tie	Prov. ties	strut	VR,s	VR,max
		Seismic Non-Seis.	spacing	No. Φ	s angle	provided	provided
-----+- (m)-----	----- (kN)-----	-----+- (mm)-----	----- (mm)-----	----- (deg)-----	----- (kN)-----	----- (kN)-----	
L End	0.50	136.8	127.2	112	6 8 110	23	367.7 367.7
Centre	5.60	123.4	106.9	330	18 8 330	22	133.2 346.8
R End	0.50	119.7	116.8	112	6 8 110	23	367.7 367.7

-----+

STOREY: 3 * BEAMS: 28 27

-----+

SUM OF BEAM/COLUMN DESIGN MOMENT RESISTANCES, SMRd,b/SMRd,c, AROUND JOINT

-----+

Beam	Beam end & direction of MRd Vector:			
	Left End +y	Left End -y	Right End +y	Right End -y
-----+-----	----- (kNm)-----	----- (kNm)-----	----- (kNm)-----	----- (kNm)-----

28	187.6 / 307.8	116.4 / 307.8	327.4 / 633.7	327.4 / 633.7
27	327.4 / 633.7	327.4 / 633.7	116.4 / 633.7	187.6 / 633.7

-----+

|Beam: 28 |
| Seismic Shear (kN)- L End: maxVEd: 135.1 minVEd: 39.4 minV/maxV: 0.29|
Seismic Shear (kN)- L End: maxVEd: 148.5 minVEd: 52.9 minV/maxV: 0.36

Region	Length	Ties design shear	max tie	Prov. ties	strut	VR,s	VR,max
		Seismic Non-Seis.	spacing	No. Φ	s angle	provided	provided
-----+- (m)-----	----- (kN)-----	-----+- (mm)-----	----- (mm)-----	----- (deg)-----	----- (kN)-----	----- (kN)-----	
L End	0.50	121.6	118.4	112	6 8 110	23	367.7 367.7
Centre	5.60	121.7	105.2	330	18 8 330	22	133.2 346.8
R End	0.50	135.1	125.6	112	6 8 110	23	367.7 367.7

-----+

|Beam: 27 |
| Seismic Shear (kN)- L End: maxVEd: 151.0 minVEd: 55.4 minV/maxV: 0.37|
Seismic Shear (kN)- L End: maxVEd: 132.6 minVEd: 36.9 minV/maxV: 0.28

Region	Length	Ties design shear	max tie	Prov. ties	strut	VR,s	VR,max
		Seismic Non-Seis.	spacing	No. Φ	s angle	provided	provided
-----+- (m)-----	----- (kN)-----	-----+- (mm)-----	----- (mm)-----	----- (deg)-----	----- (kN)-----	----- (kN)-----	
L End	0.50	137.6	127.6	112	6 8 110	23	367.7 367.7
Centre	5.60	124.2	107.3	330	18 8 330	22	133.2 346.8
R End	0.50	119.1	116.4	112	6 8 110	23	367.7 367.7

-----+

STOREY: 2 * BEAMS: 28 27

-----*

SUM OF BEAM/COLUMN DESIGN MOMENT RESISTANCES, SMR_{d,b}/SMR_{d,c}, AROUND JOINT

-----+

Beam	Beam end & direction of MRd Vector:							
	Left End	+y	Left End	-y	Right End	+y	Right End	-y
	(kNm)		(kNm)		(kNm)		(kNm)	
28	162.0	332.0	87.9	332.0	317.3	739.0	317.3	739.0
27	317.3	739.0	317.3	739.0	87.9	739.0	157.3	739.0

-----+

Beam: 28

Seismic Shear (kN)- L End: maxVED: 131.2 minVED: 45.3 minV/maxV: 0.34
 Seismic Shear (kN)- L End: maxVED: 142.7 minVED: 56.7 minV/maxV: 0.40

-----|

Region	Length	Ties design shear	max tie	Prov. ties	strut	VR,s	VR,max
		Seismic Non-Seis.	spacing	No. Φ	s	angle	provided
	(m)	(kN)	(mm)	(mm)	(deg)	(kN)	(kN)
L End	0.50	117.8	118.2	96	7 8 95	25	389.7
Centre	5.60	115.8	105.5	330	18 8 330	22	133.2
R End	0.50	129.2	125.8	112	6 8 110	25	367.7

-----+

Beam: 27

Seismic Shear (kN)- L End: maxVED: 145.2 minVED: 59.9 minV/maxV: 0.41
 Seismic Shear (kN)- L End: maxVED: 128.0 minVED: 42.8 minV/maxV: 0.33

-----|

Region	Length	Ties design shear	max tie	Prov. ties	strut	VR,s	VR,max
		Seismic Non-Seis.	spacing	No. Φ	s	angle	provided
	(m)	(kN)	(mm)	(mm)	(deg)	(kN)	(kN)
L End	0.50	131.7	128.0	112	6 8 110	23	367.7
Centre	5.60	118.3	107.6	330	18 8 330	22	133.2
R End	0.50	114.6	116.1	96	7 8 95	23	389.7

-----+

-----*

STOREY: 1 * BEAMS: 28 27

-----*

SUM OF BEAM/COLUMN DESIGN MOMENT RESISTANCES, SMR_{d,b}/SMR_{d,c}, AROUND JOINT

-----+

Beam	Beam end & direction of MRd Vector:							
	Left End	+y	Left End	-y	Right End	+y	Right End	-y
	(kNm)		(kNm)		(kNm)		(kNm)	

-----+

-----*

| 28 | 133.3 / 352.8 | 87.9 / 352.8 | 301.1 / 781.0 | 301.1 / 781.0 |
 | 27 | 301.1 / 781.0 | 301.1 / 781.0 | 87.9 / 781.0 | 126.8 / 781.0 |

-----+

|Beam: 28 |
 | Seismic Shear (kN)- L End: maxVED: 121.2 minVED: 42.1 minV/maxV: 0.35 |
 | Seismic Shear (kN)- L End: maxVED: 145.8 minVED: 66.7 minV/maxV: 0.46 |

-----|

Region	Length	Ties design shear	max tie	Prov. ties	strut	VR,s	VR,max
		Seismic Non-Seis.	spacing	No. Φ	s	angle	provided provided
	+- (m)	+- (kN)	+- (mm)	+- (mm)	+- (deg)	+- (kN)	+- (kN)
L End	0.50	107.8	114.1	112	6 8 110	23	367.7 367.7
Centre	5.60	119.0	109.6	330	18 8 330	22	133.2 346.8
R End	0.50	132.4	129.9	96	7 8 95	23	389.7 389.7

-----+

|Beam: 27 |
 | Seismic Shear (kN)- L End: maxVED: 149.1 minVED: 70.9 minV/maxV: 0.48 |
 | Seismic Shear (kN)- L End: maxVED: 117.0 minVED: 38.9 minV/maxV: 0.33 |

-----|

Region	Length	Ties design shear	max tie	Prov. ties	strut	VR,s	VR,max
		Seismic Non-Seis.	spacing	No. Φ	s	angle	provided provided
	+- (m)	+- (kN)	+- (mm)	+- (mm)	+- (deg)	+- (kN)	+- (kN)
L End	0.50	135.7	132.3	96	7 8 95	25	389.7 389.7
Centre	5.60	122.2	112.0	330	18 8 330	22	133.2 346.8
R End	0.50	103.6	111.7	112	6 8 110	25	367.7 367.7

-----+

STOREY: 0 * BEAMS: 28 27 26

SUM OF BEAM/COLUMN DESIGN MOMENT RESISTANCES, SMRd,b/SMRd,c, AROUND JOINT

-----+

Beam	Beam end & direction of MRd Vector:			
	Left End +y	Left End -y	Right End +y	Right End -y
	+- (kNm)	+- (kNm)	+- (kNm)	+- (kNm)
28	174.0 / 181.6	30.3 / 181.6	177.0 / 802.3	177.0 / 802.3
27	177.0 / 802.3	177.0 / 802.3	188.5 / 568.8	208.8 / 568.8
26	188.5 / 568.8	208.8 / 568.8	30.3 / 0.0	158.2 / 0.0

28	174.0 / 181.6	30.3 / 181.6	177.0 / 802.3	177.0 / 802.3
27	177.0 / 802.3	177.0 / 802.3	188.5 / 568.8	208.8 / 568.8
26	188.5 / 568.8	208.8 / 568.8	30.3 / 0.0	158.2 / 0.0

-----+

|Beam: 28 |

-----|

Region	Length	Ties design shear	max tie	Prov. ties	strut	VR,s	VR,max
		Seismic Non-Seis.	spacing	No. Φ	s	angle	provided provided

```

|-----+- (m) ---+----- (kN) -----+- (mm) --+----- (mm) --+- (deg) -+--- (kN) ---+--- (kN) --|
|L End | 0.50| 87.9 126.9| 330 | 3 8 330 | 22 | 133.2 | 346.8 |
|Centre| 5.60| 74.5 106.6| 330 | 18 8 330 | 22 | 133.2 | 346.8 |
|R End | 0.50| 81.4 117.1| 330 | 3 8 330 | 22 | 133.2 | 346.8 |
+-----+
|Beam: 27 |
|-----+
|Region|Length|Ties design shear|max tie|Prov. ties | strut | VR,s | VR,max |
|      |      |Seismic Non-Seis.|spacing| No. Φ s | angle |provided|provided|
|-----+- (m) ---+----- (kN) -----+- (mm) --+----- (mm) --+- (deg) -+--- (kN) ---+--- (kN) --|
|L End | 0.50| 81.8 117.6| 330 | 3 8 330 | 22 | 133.2 | 346.8 |
|Centre| 5.60| 74.2 106.1| 330 | 18 8 330 | 22 | 133.2 | 346.8 |
|R End | 0.50| 87.7 126.4| 330 | 3 8 330 | 22 | 133.2 | 346.8 |
+-----+
|Beam: 26 |
|-----+
|Region|Length|Ties design shear|max tie|Prov. ties | strut | VR,s | VR,max |
|      |      |Seismic Non-Seis.|spacing| No. Φ s | angle |provided|provided|
|-----+- (m) ---+----- (kN) -----+- (mm) --+----- (mm) --+- (deg) -+--- (kN) ---+--- (kN) --|
|L End | 0.50| 82.4 121.7| 330 | 3 8 330 | 22 | 133.2 | 346.8 |
|Centre| 5.70| 69.5 102.0| 330 | 19 8 330 | 22 | 133.2 | 346.8 |
|R End | 0.50| 82.9 122.4| 330 | 3 8 330 | 22 | 133.2 | 346.8 |
+-----+
*-----*
STOREY: -1 * BEAMS: 28 27 26
*-----*
SUM OF BEAM/COLUMN DESIGN MOMENT RESISTANCES, SMRd,b/SMRd,c, AROUND JOINT
+-----+
| Beam| Beam end & direction of MRd Vector: |
|      | Left End +y | Left End -y | Right End +y | Right End -y |
+-----+-----+-----+-----+-----+-----+-----+-----+-----+
| 28 | 158.2 / 0.0 | 30.3 / 0.0 | 180.9 / 807.3 | 180.9 / 807.3 |
| 27 | 180.9 / 807.3 | 180.9 / 807.3 | 188.5 / 351.7 | 208.8 / 351.7 |
| 26 | 188.5 / 351.7 | 208.8 / 351.7 | 30.3 / 0.0 | 150.5 / 0.0 |
+-----+
|Beam: 28 |
|-----+
|Region|Length|Ties design shear|max tie|Prov. ties | strut | VR,s | VR,max |
|      |      |Seismic Non-Seis.|spacing| No. Φ s | angle |provided|provided|
|-----+- (m) ---+----- (kN) -----+- (mm) --+----- (mm) --+- (deg) -+--- (kN) ---+--- (kN) --|
|L End | 0.50| 81.8 122.6| 330 | 3 8 330 | 22 | 133.2 | 346.8 |

```

Centre	5.60	68.4	102.2	330	18 8 330	22	133.2	346.8
R End	0.50	81.0	121.4	330	3 8 330	22	133.2	346.8
+-----+								
Beam: 27								

Region	Length	Ties design shear	max tie	Prov. ties	strut	VR,s	VR,max	
		Seismic Non-Seis.	spacing	No. Φ s	angle	provided	provided	
-----+	-(m)---+	-----	-(kN)---+	-----	-(mm)---+	-----	-(mm)---+	-----
L End	0.50	79.8	120.2	330	3 8 330	22	133.2	346.8
Centre	5.60	68.7	103.4	330	18 8 330	22	133.2	346.8
R End	0.50	82.1	123.8	330	3 8 330	22	133.2	346.8
+-----+								
Beam: 26								

Region	Length	Ties design shear	max tie	Prov. ties	strut	VR,s	VR,max	
		Seismic Non-Seis.	spacing	No. Φ s	angle	provided	provided	
-----+	-(m)---+	-----	-(kN)---+	-----	-(mm)---+	-----	-(mm)---+	-----
L End	0.50	82.7	123.3	330	3 8 330	22	133.2	346.8
Centre	5.70	69.3	103.0	330	19 8 330	22	133.2	346.8
R End	0.50	81.0	120.7	330	3 8 330	22	133.2	346.8
+-----+								

3A 3.6. FRAME 3

+-----+								
SHEAR FORCES - ULS DESIGN OF TRANSVERSE REINFORCEMENT								
+-----+								
* Concrete: C25 - Long. Reinforcement: S500 - Stirrups: S500 - Cover: 35 (mm) *								

STOREY: 6 * BEAMS: 31 30								

SUM OF BEAM/COLUMN DESIGN MOMENT RESISTANCES, $SMR_{d,b}/SMR_{d,c}$, AROUND JOINT								
+-----+								
Beam	Beam end & direction of MRd Vector:							
		Left End +y	Left End -y	Right End +y	Right End -y			
+-----+	-----	-----	-----	-----	-----	-----+		

31	108.3 /	103.8	59.0 /	103.8	235.9 /	380.2	235.9 /	380.2
30	235.9 /	380.2	235.9 /	380.2	59.0 /	380.2	108.3 /	380.2
+-----+								

```

|Beam: 31
|      Seismic Shear (kN)- L End: maxVED: 78.3 minVED: 17.9 minV/maxV: 0.23|
|      Seismic Shear (kN)- L End: maxVED: 105.2 minVED: 44.8 minV/maxV: 0.43|
|-----|
|Region|Length|Ties design shear|max tie|Prov. ties | strut | VR,s | VR,max |
|      |      |Seismic Non-Seis.|spacing| No. Φ  s | angle |provided|provided|
|-----+- (m)---+----- (kN)-----+- (mm)---+----- (mm)---+- (deg)---+--- (kN)---+--- (kN)---|
|L End | 0.50| 69.5 70.8| 112 | 6 8 110 | 23 | 367.7 | 367.7 |
|Centre| 5.60| 87.6 75.7| 330 | 18 8 330 | 22 | 133.2 | 346.8 |
|R End | 0.50| 96.4 89.1| 96 | 7 8 95 | 23 | 389.7 | 389.7 |
+-----+
|Beam: 30
|      Seismic Shear (kN)- L End: maxVED: 106.7 minVED: 45.6 minV/maxV: 0.43|
|      Seismic Shear (kN)- L End: maxVED: 77.5 minVED: 16.4 minV/maxV: 0.21|
|-----|
|Region|Length|Ties design shear|max tie|Prov. ties | strut | VR,s | VR,max |
|      |      |Seismic Non-Seis.|spacing| No. Φ  s | angle |provided|provided|
|-----+- (m)---+----- (kN)-----+- (mm)---+----- (mm)---+- (deg)---+--- (kN)---+--- (kN)---|
|L End | 0.50| 97.9 90.2| 96 | 7 8 95 | 25 | 389.7 | 389.7 |
|Centre| 5.60| 89.1 76.8| 330 | 18 8 330 | 22 | 133.2 | 346.8 |
|R End | 0.50| 68.7 69.7| 112 | 6 8 110 | 25 | 367.7 | 367.7 |
+-----+
*-----*
STOREY: 5 * BEAMS: 31 30
*-----*
SUM OF BEAM/COLUMN DESIGN MOMENT RESISTANCES, SMRd,b/SMRd,c, AROUND JOINT
+-----+
| Beam|          Beam end & direction of MRd Vector:          |
|      | Left End +y | Left End -y | Right End +y | Right End -y |
+-----+----- (kNm)-----+----- (kNm)-----+----- (kNm)-----+----- (kNm)-----+
*-----*
| 31 | 144.7 / 226.6 | 87.9 / 226.6 | 249.4 / 734.1 | 249.4 / 734.1 |
| 30 | 249.4 / 734.1 | 249.4 / 734.1 | 87.9 / 734.1 | 144.7 / 734.1 |
+-----+
|Beam: 31
|      Seismic Shear (kN)- L End: maxVED: 93.7 minVED: 20.7 minV/maxV: 0.22|
|      Seismic Shear (kN)- L End: maxVED: 102.4 minVED: 29.4 minV/maxV: 0.29|
|-----|
|Region|Length|Ties design shear|max tie|Prov. ties | strut | VR,s | VR,max |
|      |      |Seismic Non-Seis.|spacing| No. Φ  s | angle |provided|provided|
|-----+- (m)---+----- (kN)-----+- (mm)---+----- (mm)---+- (deg)---+--- (kN)---+--- (kN)---|
|L End | 0.50| 84.9 77.5| 96 | 7 8 95 | 25 | 389.7 | 389.7 |

```

Centre	5.60	84.8	69.0	330	18 8 330	22	133.2	346.8
R End	0.50	93.6	82.3	112	6 8 110	25	367.7	367.7

-----+

|Beam: 30 |

| Seismic Shear (kN)- L End: maxVED: 104.8 minVED: 31.8 minV/maxV: 0.30|

| Seismic Shear (kN)- L End: maxVED: 91.3 minVED: 18.3 minV/maxV: 0.20|

-----|

Region	Length	Ties design shear	max tie	Prov. ties	strut	VR,s	VR,max	
		Seismic Non-Seis.	spacing	No. Φ s	angle	provided	provided	
-----+- (m)-----	----- (kN)-----	-----+- (mm)-----	----- (mm)-----	----- (deg)-----	----- (kN)-----	----- (kN)-----	-----	
L End	0.50	96.0	84.0	112	6 8 110	23	367.7	367.7
Centre	5.60	87.2	70.7	330	18 8 330	22	133.2	346.8
R End	0.50	82.5	75.8	96	7 8 95	23	389.7	389.7

-----+

STOREY: 4 * BEAMS: 31 30

SUM OF BEAM/COLUMN DESIGN MOMENT RESISTANCES, SMRd,b/SMRd,c, AROUND JOINT

-----+

Beam	Beam end & direction of MRd Vector:			
	Left End +y	Left End -y	Right End +y	Right End -y
-----+-----	-----+-----	-----+-----	-----+-----	-----+-----
	(kNm)-----	(kNm)-----	(kNm)-----	(kNm)-----
31	140.8 / 261.6	87.9 / 261.6	249.4 / 609.8	249.4 / 609.8
30	249.4 / 609.8	249.4 / 609.8	87.9 / 609.8	133.3 / 609.8

-----+

|Beam: 31 |

| Seismic Shear (kN)- L End: maxVED: 91.5 minVED: 19.1 minV/maxV: 0.21|

| Seismic Shear (kN)- L End: maxVED: 104.0 minVED: 31.6 minV/maxV: 0.30|

-----|

Region	Length	Ties design shear	max tie	Prov. ties	strut	VR,s	VR,max	
		Seismic Non-Seis.	spacing	No. Φ s	angle	provided	provided	
-----+- (m)-----	----- (kN)-----	-----+- (mm)-----	----- (mm)-----	----- (deg)-----	----- (kN)-----	----- (kN)-----	-----	
L End	0.50	82.7	76.5	96	7 8 95	25	389.7	389.7
Centre	5.60	86.4	70.0	330	18 8 330	22	133.2	346.8
R End	0.50	95.2	83.4	112	6 8 110	25	367.7	367.7

-----+

|Beam: 30 |

| Seismic Shear (kN)- L End: maxVED: 106.0 minVED: 34.7 minV/maxV: 0.33|

| Seismic Shear (kN)- L End: maxVED: 88.4 minVED: 17.1 minV/maxV: 0.19|

-----|

Region	Length	Ties design shear	max tie	Prov. ties	strut	VR,s	VR,max
--------	--------	-------------------	---------	------------	-------	------	--------

SUM OF BEAM/COLUMN DESIGN MOMENT RESISTANCES, SMR_{d,b}/SMR_{d,c}, AROUND JOINT

+-----+

Beam	Beam end & direction of MRd Vector:			
	Left End +y	Left End -y	Right End +y	Right End -y
	(kNm)	(kNm)	(kNm)	(kNm)

31	126.8 / 314.5	87.9 / 314.5	242.2 / 704.4	242.2 / 704.4
30	242.2 / 704.4	242.2 / 704.4	87.9 / 704.4	126.8 / 704.4

|Beam: 31

| Seismic Shear (kN)- L End: maxVEd: 89.5 minVEd: 20.2 minV/maxV: 0.23|

| Seismic Shear (kN)- L End: maxVEd: 102.9 minVEd: 33.6 minV/maxV: 0.33|

Region	Length	Ties design shear	max tie	Prov. ties	strut	VR,s	VR,max
	(m)	(kN)	(mm)	(mm)	(deg)	(kN)	(kN)
L End	0.50	80.7 76.4	96	7 8 95	25	389.7	389.7
Centre	5.60	85.3 70.1	330	18 8 330	22	133.2	346.8
R End	0.50	94.1 83.4	112	6 8 110	25	367.7	367.7

|Beam: 30

| Seismic Shear (kN)- L End: maxVEd: 105.0 minVEd: 35.7 minV/maxV: 0.34|

| Seismic Shear (kN)- L End: maxVEd: 87.4 minVEd: 18.1 minV/maxV: 0.21|

Region	Length	Ties design shear	max tie	Prov. ties	strut	VR,s	VR,max
	(m)	(kN)	(mm)	(mm)	(deg)	(kN)	(kN)
L End	0.50	96.2 85.2	112	6 8 110	23	367.7	367.7
Centre	5.60	87.4 71.9	330	18 8 330	22	133.2	346.8
R End	0.50	78.6 74.6	96	7 8 95	23	389.7	389.7

STOREY: 1 * BEAMS: 31 30

SUM OF BEAM/COLUMN DESIGN MOMENT RESISTANCES, SMR_{d,b}/SMR_{d,c}, AROUND JOINT

+-----+

Beam	Beam end & direction of MRd Vector:			
	Left End +y	Left End -y	Right End +y	Right End -y
	(kNm)	(kNm)	(kNm)	(kNm)

31	108.3 / 333.3	59.0 / 333.3	242.2 / 749.0	242.2 / 749.0
----	---------------	--------------	---------------	---------------

```

| 30 | 242.2 / 749.0 | 242.2 / 749.0 | 59.0 / 749.0 | 108.3 / 749.0 |
+-----+
|Beam: 31 |
| Seismic Shear (kN)- L End: maxVED: 83.4 minVED: 21.4 minV/maxV: 0.26|
| Seismic Shear (kN)- L End: maxVED: 101.7 minVED: 39.7 minV/maxV: 0.39|
+-----+
|Region|Length|Ties design shear|max tie|Prov. ties | strut | VR,s | VR,max |
| | | |Seismic Non-Seis.|spacing| No. Φ s | angle |provided|provided|
|-----+-(m)---+------(kN)-----+-(mm)---+------(mm)---+-(deg)---+-(kN)---+-(kN)---|
|L End | 0.50| 74.6 74.0| 112 | 6 8 110 | 23 | 367.7 | 367.7 |
|Centre| 5.60| 84.2 72.5| 330 | 18 8 330 | 22 | 133.2 | 346.8 |
|R End | 0.50| 92.9 85.8| 96 | 7 8 95 | 23 | 389.7 | 389.7 |
+-----+
|Beam: 30 |
| Seismic Shear (kN)- L End: maxVED: 104.9 minVED: 42.9 minV/maxV: 0.41|
| Seismic Shear (kN)- L End: maxVED: 80.2 minVED: 18.2 minV/maxV: 0.23|
+-----+
|Region|Length|Ties design shear|max tie|Prov. ties | strut | VR,s | VR,max |
| | | |Seismic Non-Seis.|spacing| No. Φ s | angle |provided|provided|
|-----+-(m)---+------(kN)-----+-(mm)---+------(mm)---+-(deg)---+-(kN)---+-(kN)---|
|L End | 0.50| 96.1 88.1| 96 | 7 8 95 | 25 | 389.7 | 389.7 |
|Centre| 5.60| 87.3 74.8| 330 | 18 8 330 | 22 | 133.2 | 346.8 |
|R End | 0.50| 71.4 71.7| 112 | 6 8 110 | 25 | 367.7 | 367.7 |
+-----+
*-----*
STOREY: 0 * BEAMS: 31 30 29
*-----*
SUM OF BEAM/COLUMN DESIGN MOMENT RESISTANCES, SMRd,b/SMRd,c, AROUND JOINT
+-----+
| Beam| Beam end & direction of MRd Vector: |
| | Left End +y | Left End -y | Right End +y | Right End -y |
+-----+------(kNm)-----+------(kNm)-----+------(kNm)-----+------(kNm)-----+
*-----*
| 31 | 111.3 / 170.7 | 30.3 / 170.7 | 158.7 / 780.8 | 158.7 / 780.8 |
| 30 | 158.7 / 780.8 | 158.7 / 780.8 | 188.5 / 546.5 | 158.7 / 546.5 |
| 29 | 188.5 / 546.5 | 158.7 / 546.5 | 30.3 / 0.0 | 150.5 / 0.0 |
+-----+
|Beam: 31 |
+-----+
|Region|Length|Ties design shear|max tie|Prov. ties | strut | VR,s | VR,max |
| | | |Seismic Non-Seis.|spacing| No. Φ s | angle |provided|provided|
|-----+-(m)---+------(kN)-----+-(mm)---+------(mm)---+-(deg)---+-(kN)---+-(kN)---|

```

L End	0.50	58.2	81.7	330	3	8	330	22	133.2	346.8
Centre	5.60	49.4	68.4	330	18	8	330	22	133.2	346.8
R End	0.50	55.8	78.2	330	3	8	330	22	133.2	346.8

-----+
|Beam: 30 |

Region	Length	Ties design shear	max tie	Prov. ties	strut	VR,s	VR,max			
		Seismic Non-Seis.	spacing	No. Φ s	angle	provided	provided			
-----+--	(m)---+-----	(kN)-----+--	(mm)---+-----	(mm)---+--	(deg)---+--	(kN)---+--	(kN)---+--			
L End	0.50	53.7	75.3	330	3	8	330	22	133.2	346.8
Centre	5.60	51.0	71.2	330	18	8	330	22	133.2	346.8
R End	0.50	59.8	84.5	330	3	8	330	22	133.2	346.8

-----+
|Beam: 29 |

Region	Length	Ties design shear	max tie	Prov. ties	strut	VR,s	VR,max			
		Seismic Non-Seis.	spacing	No. Φ s	angle	provided	provided			
-----+--	(m)---+-----	(kN)-----+--	(mm)---+-----	(mm)---+--	(deg)---+--	(kN)---+--	(kN)---+--			
L End	0.50	83.5	123.3	330	3	8	330	22	133.2	346.8
Centre	5.70	70.1	102.9	330	19	8	330	22	133.2	346.8
R End	0.50	81.8	120.7	330	3	8	330	22	133.2	346.8

-----+

STOREY: -1 * BEAMS: 31 30 29

-----+
SUM OF BEAM/COLUMN DESIGN MOMENT RESISTANCES, SMR_{d,b}/SMR_{d,c}, AROUND JOINT

Beam	Beam end & direction of MRd Vector:							
	Left End	+y	Left End	-y	Right End	+y	Right End	-y
-----+--	(kNm)-----+--	(kNm)-----+--	(kNm)-----+--	(kNm)-----+--	(kNm)-----+--	(kNm)-----+--	(kNm)-----+--	(kNm)-----+--
31	101.4 /	0.0	30.3 /	0.0	164.7 /	799.8	164.7 /	799.8
30	164.7 /	799.8	164.7 /	799.8	204.3 /	332.8	149.5 /	332.8
29	204.3 /	332.8	149.5 /	332.8	30.3 /	0.0	150.5 /	0.0

-----+
|Beam: 31 |

Region	Length	Ties design shear	max tie	Prov. ties	strut	VR,s	VR,max			
		Seismic Non-Seis.	spacing	No. Φ s	angle	provided	provided			
-----+--	(m)---+-----	(kN)-----+--	(mm)---+-----	(mm)---+--	(deg)---+--	(kN)---+--	(kN)---+--			
L End	0.50	54.0	80.5	330	3	8	330	22	133.2	346.8
Centre	5.60	45.2	67.2	330	18	8	330	22	133.2	346.8

6-Base	+E		69.8	59.3	-468.2	231.7	333.3	
	-E		-69.8	-59.3	468.2	-231.7	264.2	
5-Base	+E		71.1	50.1	-854.7	479.1	684.2	
	-E		-71.1	-50.1	854.7	-479.1	516.2	
4-Base	+E		80.6	55.2	-1809.5	637.0	1034.7	
	-E		-80.6	-55.2	1809.5	-637.0	764.8	
3-Base	+E		90.5	57.2	-3226.6	783.9	1384.3	
	-E		-90.5	-57.2	3226.6	-783.9	1010.8	
2-Base	+E		79.0	47.7	-5149.6	917.1	1728.9	
	-E		-79.0	-47.7	5149.6	-917.1	1257.0	
1-Base	+E		164.4	56.2	-10734.9	1548.1	2093.3	
	-E		-164.4	-56.2	10734.9	-1548.1	1537.0	

-----+

ENVELOPES OF DESIGN MOMENTS AT STORY BASE - STORY DESIGN SHEARS (MAGNIFIED)

-----+

STORY	Seismic action	Myd	Vyd	Mzd	Vzd	Nd	
-----+	-----+	(kNm)	(kN)	(kNm)	(kN)	(kN)	----
6-top	+Mx +Mz / maxN	208.0	2.4	2264.3	343.7	0.0	
	-Mx +Mz / maxN	-8.2	-116.2	2264.3	343.7	0.0	
	+Mx -Mz / maxN	208.0	2.4	-2263.8	-351.3	0.0	
	-Mx -Mz / maxN	-8.2	-116.2	-2263.8	-351.3	0.0	
	+Mx +Mz / minN	208.0	2.4	2264.3	343.7	264.2	
	-Mx +Mz / minN	-8.2	-116.2	2264.3	343.7	264.2	
	+Mx -Mz / minN	208.0	2.4	-2263.8	-351.3	264.2	
	-Mx -Mz / minN	-8.2	-116.2	-2263.8	-351.3	264.2	
-----+							
6-base	+Mx +Mz / maxN	-0.9	2.4	3962.2	343.7	333.3	
	-Mx +Mz / maxN	-140.5	-116.2	3962.2	343.7	333.3	
	+Mx -Mz / maxN	-0.9	2.4	-3947.7	-351.3	333.3	
	-Mx -Mz / maxN	-140.5	-116.2	-3947.7	-351.3	333.3	
	+Mx +Mz / minN	-0.9	2.4	3962.2	343.7	264.2	
	-Mx +Mz / minN	-140.5	-116.2	3962.2	343.7	264.2	
	+Mx -Mz / minN	-0.9	2.4	-3947.7	-351.3	264.2	
	-Mx -Mz / minN	-140.5	-116.2	-3947.7	-351.3	264.2	
-----+							
5-base	+Mx +Mz / maxN	17.1	16.0	5661.9	715.6	684.2	
	-Mx +Mz / maxN	-125.1	-84.1	5661.9	715.6	684.2	
	+Mx -Mz / maxN	17.1	16.0	-5637.9	-721.9	684.2	
	-Mx -Mz / maxN	-125.1	-84.1	-5637.9	-721.9	684.2	
	+Mx +Mz / minN	17.1	16.0	5661.9	715.6	516.2	
	-Mx +Mz / minN	-125.1	-84.1	5661.9	715.6	516.2	
	+Mx -Mz / minN	17.1	16.0	-5637.9	-721.9	516.2	

	-Mx -Mz / minN	-125.1	-84.1	-5637.9	-721.9	516.2
+-----+						
4-base	+Mx +Mz / maxN	24.6	17.2	7362.2	952.2	1034.7
	-Mx +Mz / maxN	-136.6	-93.2	7362.2	952.2	1034.7
	+Mx -Mz / maxN	24.6	17.2	-7327.6	-958.7	1034.7
	-Mx -Mz / maxN	-136.6	-93.2	-7327.6	-958.7	1034.7
	+Mx +Mz / minN	24.6	17.2	7362.2	952.2	764.8
	-Mx +Mz / minN	-136.6	-93.2	7362.2	952.2	764.8
	+Mx -Mz / minN	24.6	17.2	-7327.6	-958.7	764.8
	-Mx -Mz / minN	-136.6	-93.2	-7327.6	-958.7	764.8
+-----+						
3-base	+Mx +Mz / maxN	39.5	22.6	9063.1	1172.5	1384.3
	-Mx +Mz / maxN	-141.6	-91.7	9063.1	1172.5	1384.3
	+Mx -Mz / maxN	39.5	22.6	-9016.6	-1179.1	1384.3
	-Mx -Mz / maxN	-141.6	-91.7	-9016.6	-1179.1	1384.3
	+Mx +Mz / minN	39.5	22.6	9063.1	1172.5	1010.8
	-Mx +Mz / minN	-141.6	-91.7	9063.1	1172.5	1010.8
	+Mx -Mz / minN	39.5	22.6	-9016.6	-1179.1	1010.8
	-Mx -Mz / minN	-141.6	-91.7	-9016.6	-1179.1	1010.8
+-----+						
2-base	+Mx +Mz / maxN	22.9	11.4	10765.2	1372.2	1728.9
	-Mx +Mz / maxN	-135.1	-84.0	10765.2	1372.2	1728.9
	+Mx -Mz / maxN	22.9	11.4	-10704.5	-1379.0	1728.9
	-Mx -Mz / maxN	-135.1	-84.0	-10704.5	-1379.0	1728.9
	+Mx +Mz / minN	22.9	11.4	10765.2	1372.2	1257.0
	-Mx +Mz / minN	-135.1	-84.0	10765.2	1372.2	1257.0
	+Mx -Mz / minN	22.9	11.4	-10704.5	-1379.0	1257.0
	-Mx -Mz / minN	-135.1	-84.0	-10704.5	-1379.0	1257.0
+-----+						
1-base	+Mx +Mz / maxN	133.3	38.9	10789.1	2315.6	2093.3
	Corres. base MRd	871.3		14001.8	at vd =	0.105
	-Mx +Mz / maxN	-195.5	-73.5	10789.1	2315.6	2093.3
	Corres. base MRd	871.3		14001.8	at vd =	0.105
	+Mx -Mz / maxN	133.3	38.9	-10680.6	-2328.7	2093.3
	Corres. base MRd	871.3		14001.8	at vd =	0.105
	-Mx -Mz / maxN	-195.5	-73.5	-10680.6	-2328.7	2093.3
	Corres. base MRd	871.3		14001.8	at vd =	0.105
	+Mx +Mz / minN	133.3	38.9	10789.1	2315.6	1537.0
	Corres. base MRd	824.5		12868.0	at vd =	0.077
	-Mx +Mz / minN	-195.5	-73.5	10789.1	2315.6	1537.0
	Corres. base MRd	824.5		12868.0	at vd =	0.077
	+Mx -Mz / minN	133.3	38.9	-10680.6	-2328.7	1537.0

	Corres. base MRd	824.5	12868.0	at vd = 0.077	
	-Mx -Mz / minN	-195.5	-73.5	-10680.6	-2328.7 1537.0
	Corres. base MRd	824.5	12868.0	at vd = 0.077	

DESIGN IN SHEAR W/O SHORT-SHEAR-SPAN EFFECTS (Web diagonal compression/tension)

Storey and location	Magn. factor	Design shear maxVEd	Horizontal bars dia. legs max./provided	strut spacing-sh 	angle	Resistance VR,s	Resistance VR,max
-----	-----	(kN) -+ (mm)	(mm)	-----	(deg)	(kN)	(kN)
6 Along bz	1.5	351	8 2 165 165	22	2119.2	2979.3	
5 Along bz	1.5	721	8 2 165 165	22	2119.2	2979.3	
4 Along bz	1.5	958	8 2 165 165	22	2119.2	2979.3	
3 Along bz	1.5	1179	8 2 165 165	22	2119.2	2979.3	
2 Along bz	1.5	1379	8 2 165 165	22	2119.2	2979.3	
1 Along bz	1.5	2328	8 2 165 150	22	2331.2	2979.3	

 VERTICAL / HORIZONTAL / HOOP REINFORCEMENT (Story and base of above)

	BOUNDARY ELEMENTS						WEB REINFORCEMENT			Addit
STOR	Dimens.	Vertical bars			Hoops	omega-wd	Vertical	Horizontal	Joint	
	dia tot end side	dia. sh	Req/Prov	dia. sv	No.	dia. sh	reinf			
-----	(m)-----	(mm)	-----	(mm)	-----	(mm)	-----	(mm)	-----	(mm2)
6	0.25X0.30	20 10 4 3	8 140 0.00 0.24	8 160 22	8 165	0				
5	0.30X0.30	20 12 4 4	8 140 0.00 0.22	8 160 21	8 165	0				
4	0.35X0.30	20 14 4 5	8 140 0.00 0.21	8 160 21	8 165	0				
3	0.40X0.30	20 16 4 6	8 140 0.00 0.19	8 160 20	8 165	0				
2	0.60X0.30	20 18 4 7	8 140 0.00 0.19	8 160 18	8 165	0				
1	0.60X0.30	20 18 4 7	8 140 0.00 0.19	8 160 18	8 150	0				
0	0.60X0.30	20 18 4 7	8 140 0.00 0.19	8 160 18	8 150	0				

3A 4.2. WALL W3

```

*-----*
* WALL :      3
*-----*
* Concrete: C25 - Long. Reinforcement: S500 - Stirrups: S500 - Cover: 35 (mm) *
*-----*
* GEOMETRY
* M-V AT STORY LEVELS - ANALYSIS FOR DESIGN SEISMIC ACTION - N DUE TO G+ψ2Q *

```

```

+-----+
|X-Sect.: RECT. | bw (m): 0.25 | lw (m): 4.00 |
|Total/Critical Height(m):19.00/4.00 | | |
|-----|

```

STORY	Seismic action	My	Vy	Mz	Vz	N
		(kNm)	(kN)	(kNm)	(kN)	(kN)
6-Top	+E	0.0	2.7	0.0	130.5	195.3
	-E	0.0	-2.7	0.0	-130.5	195.3
6-Base	+E	8.1	2.7	-391.5	130.5	195.3
	-E	-8.1	-2.7	391.5	-130.5	195.3
5-Base	+E	5.3	2.3	-551.1	171.9	390.6
	-E	-5.3	-2.3	551.1	-171.9	390.6
4-Base	+E	6.2	1.0	-1142.3	278.5	585.9
	-E	-6.2	-1.0	1142.3	-278.5	585.9
3-Base	+E	9.1	2.9	-2142.0	388.0	781.2
	-E	-9.1	-2.9	2142.0	-388.0	781.2
2-Base	+E	6.3	2.0	-3444.8	478.6	976.5
	-E	-6.3	-2.0	3444.8	-478.6	976.5
1-Base	+E	57.6	14.1	-3974.0	200.2	1196.8
	-E	-57.6	-14.1	3974.0	-200.2	1196.8
0-Base	+E	15.8	24.5	-840.6	1044.6	1392.1
	-E	-15.8	-24.5	840.6	-1044.6	1392.1
-1-Base	+E	10.0	8.6	-672.2	61.3	1587.4
	-E	-10.0	-8.6	672.2	-61.3	1587.4

```

+-----+
ENVELOPES OF DESIGN MOMENTS AT STORY BASE - STORY DESIGN SHEARS (MAGNIFIED)
+-----+

```

STORY	Seismic action	Myd	Vyd	Mzd	Vzd	Nd
		(kNm)	(kN)	(kNm)	(kN)	(kN)
6-top	+Mx +Mz / maxN	0.0	2.7	1989.3	194.3	0.0
	-Mx +Mz / maxN	0.0	-2.7	1989.3	194.3	0.0
	+Mx -Mz / maxN	0.0	2.7	-1990.8	-197.2	0.0
	-Mx -Mz / maxN	0.0	-2.7	-1990.8	-197.2	0.0

		+Mx +Mz / minN		0.0	2.7	1989.3	194.3	195.3	
		-Mx +Mz / minN		0.0	-2.7	1989.3	194.3	195.3	
		+Mx -Mz / minN		0.0	2.7	-1990.8	-197.2	195.3	
		-Mx -Mz / minN		0.0	-2.7	-1990.8	-197.2	195.3	
+-----+									
	6-base	+Mx +Mz / maxN		8.1	2.7	2390.6	194.3	195.3	
		-Mx +Mz / maxN		-8.1	-2.7	2390.6	194.3	195.3	
		+Mx -Mz / maxN		8.1	2.7	-2382.0	-197.2	195.3	
		-Mx -Mz / maxN		-8.1	-2.7	-2382.0	-197.2	195.3	
		+Mx +Mz / minN		8.1	2.7	2390.6	194.3	195.3	
		-Mx +Mz / minN		-8.1	-2.7	2390.6	194.3	195.3	
		+Mx -Mz / minN		8.1	2.7	-2382.0	-197.2	195.3	
		-Mx -Mz / minN		-8.1	-2.7	-2382.0	-197.2	195.3	
+-----+									
	5-base	+Mx +Mz / maxN		5.3	2.3	2791.5	256.5	390.6	
		-Mx +Mz / maxN		-5.3	-2.3	2791.5	256.5	390.6	
		+Mx -Mz / maxN		5.3	2.3	-2774.9	-259.1	390.6	
		-Mx -Mz / maxN		-5.3	-2.3	-2774.9	-259.1	390.6	
		+Mx +Mz / minN		5.3	2.3	2791.5	256.5	390.6	
		-Mx +Mz / minN		-5.3	-2.3	2791.5	256.5	390.6	
		+Mx -Mz / minN		5.3	2.3	-2774.9	-259.1	390.6	
		-Mx -Mz / minN		-5.3	-2.3	-2774.9	-259.1	390.6	
+-----+									
	4-base	+Mx +Mz / maxN		6.2	1.0	3193.0	416.2	585.9	
		-Mx +Mz / maxN		-6.2	-1.0	3193.0	416.2	585.9	
		+Mx -Mz / maxN		6.2	1.0	-3167.3	-419.2	585.9	
		-Mx -Mz / maxN		-6.2	-1.0	-3167.3	-419.2	585.9	
		+Mx +Mz / minN		6.2	1.0	3193.0	416.2	585.9	
		-Mx +Mz / minN		-6.2	-1.0	3193.0	416.2	585.9	
		+Mx -Mz / minN		6.2	1.0	-3167.3	-419.2	585.9	
		-Mx -Mz / minN		-6.2	-1.0	-3167.3	-419.2	585.9	
+-----+									
	3-base	+Mx +Mz / maxN		9.1	2.9	3595.2	580.2	781.2	
		-Mx +Mz / maxN		-9.1	-2.9	3595.2	580.2	781.2	
		+Mx -Mz / maxN		9.1	2.9	-3559.0	-583.7	781.2	
		-Mx -Mz / maxN		-9.1	-2.9	-3559.0	-583.7	781.2	
		+Mx +Mz / minN		9.1	2.9	3595.2	580.2	781.2	
		-Mx +Mz / minN		-9.1	-2.9	3595.2	580.2	781.2	
		+Mx -Mz / minN		9.1	2.9	-3559.0	-583.7	781.2	
		-Mx -Mz / minN		-9.1	-2.9	-3559.0	-583.7	781.2	
+-----+									
	2-base	+Mx +Mz / maxN		6.3	2.0	3997.9	716.0	976.5	

		-Mx +Mz / maxN		-6.3	-2.0	3997.9	716.0	976.5	
		+Mx -Mz / maxN		6.3	2.0	-3950.1	-719.8	976.5	
		-Mx -Mz / maxN		-6.3	-2.0	-3950.1	-719.8	976.5	
		+Mx +Mz / minN		6.3	2.0	3997.9	716.0	976.5	
		-Mx +Mz / minN		-6.3	-2.0	3997.9	716.0	976.5	
		+Mx -Mz / minN		6.3	2.0	-3950.1	-719.8	976.5	
		-Mx -Mz / minN		-6.3	-2.0	-3950.1	-719.8	976.5	
+-----+									
	1-base	+Mx +Mz / maxN		57.6	14.1	3999.0	300.1	1196.8	
		Corres. base MRd		308.0		5491.1	at vd =	0.072	
		-Mx +Mz / maxN		-57.6	-14.1	3999.0	300.1	1196.8	
		Corres. base MRd		308.0		5491.1	at vd =	0.072	
		+Mx -Mz / maxN		57.6	14.1	-3949.0	-300.7	1196.8	
		Corres. base MRd		308.0		5491.1	at vd =	0.072	
		-Mx -Mz / maxN		-57.6	-14.1	-3949.0	-300.7	1196.8	
		Corres. base MRd		308.0		5491.1	at vd =	0.072	
		+Mx +Mz / minN		57.6	14.1	3999.0	300.1	1196.8	
		Corres. base MRd		308.0		5491.1	at vd =	0.072	
		-Mx +Mz / minN		-57.6	-14.1	3999.0	300.1	1196.8	
		Corres. base MRd		308.0		5491.1	at vd =	0.072	
		+Mx -Mz / minN		57.6	14.1	-3949.0	-300.7	1196.8	
		Corres. base MRd		308.0		5491.1	at vd =	0.072	
		-Mx -Mz / minN		-57.6	-14.1	-3949.0	-300.7	1196.8	
		Corres. base MRd		308.0		5491.1	at vd =	0.072	
+-----+									
	0-base	+Mx +Mz / maxN		31.2	24.5	3977.1	1051.9	1392.1	
		-Mx +Mz / maxN		-31.2	-0.3	3977.1	25.8	1392.1	
		+Mx -Mz / maxN		31.2	0.0	-3970.9	7.3	1392.1	
		-Mx -Mz / maxN		-31.2	0.0	-3970.9	7.3	1392.1	
		+Mx +Mz / minN		31.2	0.0	3977.1	7.3	1392.1	
		-Mx +Mz / minN		-31.2	0.0	3977.1	7.3	1392.1	
		+Mx -Mz / minN		31.2	0.0	-3970.9	7.3	1392.1	
		-Mx -Mz / minN		-31.2	0.0	-3970.9	7.3	1392.1	
+-----+									
	-1-base	+Mx +Mz / maxN		2.4	10.6	2650.0	729.4	1587.4	
		-Mx +Mz / maxN		-2.4	-0.1	2650.0	2.3	1587.4	
		+Mx -Mz / maxN		2.4	0.0	-2648.7	0.8	1587.4	
		-Mx -Mz / maxN		-2.4	0.0	-2648.7	0.8	1587.4	
		+Mx +Mz / minN		2.4	0.0	2650.0	0.8	1587.4	
		-Mx +Mz / minN		-2.4	0.0	2650.0	0.8	1587.4	
		+Mx -Mz / minN		2.4	0.0	-2648.7	0.8	1587.4	
		-Mx -Mz / minN		-2.4	0.0	-2648.7	0.8	1587.4	

DESIGN IN SHEAR W/O SHORT-SHEAR-SPAN EFFECTS (Web diagonal compression/tension)											
Storey and location	Magn. factor	Design shear	maxVEd	dia. legs	Horizontal bars spacing	Horizontal bars spacing	strut angle	Resistance VR,s	Resistance VR,max		
		(kN)	(mm)		(mm)	(mm)	(deg)	(kN)	(kN)		
6 Along bz	1.5	197	8	2	200	200	22	1748.4	2482.8		
5 Along bz	1.5	259	8	2	200	200	22	1748.4	2482.8		
4 Along bz	1.5	419	8	2	200	200	22	1748.4	2482.8		
3 Along bz	1.5	583	8	2	200	200	22	1748.4	2482.8		
2 Along bz	1.5	719	8	2	200	200	22	1748.4	2482.8		
1 Along bz	1.5	300	8	2	200	200	22	1748.4	2482.8		
0 Along bz	1.5	1051	8	2	200	200	22	1748.4	2482.8		
-1 Along bz	1.5	729	8	2	200	200	22	1748.4	2482.8		
VERTICAL / HORIZONTAL / HOOP REINFORCEMENT (Story and base of above)											
BOUNDARY ELEMENTS											
STOR	Dimens.	Vertical bars				Hoops		omega-wd	WEB REINFORCEMENT		Addit
	(m)	dia	tot	end	side	dia. sh	Req/Prov	dia. sv	No.	dia. sh	reinft
		(mm)				(mm)		(mm)		(mm)	(mm2)
6	0.60X0.25	14	9	3	3	8	105 0.00 0.24	8	200 14	8 200	0
5	0.60X0.25	14	9	3	3	8	105 0.00 0.24	8	200 14	8 200	0
4	0.60X0.25	14	9	3	3	8	105 0.00 0.24	8	200 14	8 200	0
3	0.60X0.25	14	9	3	3	8	105 0.00 0.24	8	200 14	8 200	0
2	0.60X0.25	14	9	3	3	8	105 0.00 0.24	8	200 14	8 200	0
1	0.60X0.25	14	9	3	3	8	105 0.00 0.24	8	200 14	8 200	0
0	0.60X0.25	14	9	3	3	8	105 0.00 0.24	8	200 14	8 200	0
-1	0.60X0.25	14	9	3	3	8	105 0.00 0.24	8	200 14	8 200	0
-2	0.60X0.25	14	9	3	3	8	105 0.00 0.24	8	200 14	8 200	0

3A 4.3. WALL W5

```

*-----*
* WALL :      5
*-----*
* Concrete: C25 - Long. Reinforcement: S500 - Stirrups: S500 - Cover: 35 (mm) *
*-----*
* GEOMETRY
* M-V AT STORY LEVELS - ANALYSIS FOR DESIGN SEISMIC ACTION - N DUE TO G+ψ2Q *
+-----+
|X-Section U  flanges(m): 1.80, web(m): 3.60, stubs(m): 0.00 0.00(m)-thick |
|Tot./Cr.Height(m): 19.00/ 3.60, flange / web thickness (m): 0.25 / 0.25 |
|-----|
| STORY |Seismic action|          My          Vy          Mz          Vz          N |
|-----+-----+----- (kNm)----- (kN)----- (kNm)----- (kN)----- (kN)---|
| 6-Top |      +E      |           0.0      -628.5          0.0      -63.7      289.2 |
|      |      -E      |           0.0       628.5          0.0       63.7      289.2 |
| 6-Base|      +E      |      -1885.5      -628.5          191.0      -63.7      289.2 |
|      |      -E      |       1885.5       628.5         -191.0       63.7      289.2 |
| 5-Base|      +E      |      -2218.3      -458.3          214.8      -75.4      578.5 |
|      |      -E      |       2218.3       458.3         -214.8       75.4      578.5 |
| 4-Base|      +E      |      -2738.0      -668.8          415.9     -104.6      867.7 |
|      |      -E      |       2738.0       668.8         -415.9      104.6      867.7 |
| 3-Base|      +E      |      -4374.9      -976.9          774.3     -144.7     1156.9 |
|      |      -E      |       4374.9       976.9         -774.3      144.7     1156.9 |
| 2-Base|      +E      |      -7657.6     -1380.0         1306.8     -196.8     1446.1 |
|      |      -E      |       7657.6      1380.0        -1306.8      196.8     1446.1 |
| 1-Base|      +E      |     -14277.1     -1797.3         1744.5     -131.6     1777.2 |
|      |      -E      |      14277.1      1797.3        -1744.5      131.6     1777.2 |
| 0-Base|      +E      |      -5057.0     -3073.4           45.1     -566.5     2066.4 |
|      |      -E      |       5057.0      3073.4          -45.1      566.5     2066.4 |
| -1-Base|      +E      |      -3186.4      -624.0          238.5      -64.6     2355.7 |
|      |      -E      |       3186.4       624.0         -238.5       64.6     2355.7 |
+-----+
ENVELOPES OF DESIGN MOMENTS AT STORY BASE - STORY DESIGN SHEARS (MAGNIFIED)
+-----+
| STORY | Seismic action |          Myd          Vyd          Mzd          Vzd          Nd |
|-----+-----+----- (kNm)----- (kN)----- (kNm)----- (kN)----- (kN)---|
| 6-top | +Mx +Mz / maxN |      -2705.1      -942.8          -165.3      -94.9           0.0 |
|      | -Mx +Mz / maxN |       2705.1       942.8          -165.3      -94.9           0.0 |

```

		+Mx -Mz / maxN		-2705.1	-942.8	165.8	96.0	0.0	
		-Mx -Mz / maxN		2705.1	942.8	165.8	96.0	0.0	
		+Mx +Mz / minN		-2705.1	-942.8	-165.3	-94.9	289.2	
		-Mx +Mz / minN		2705.1	942.8	-165.3	-94.9	289.2	
		+Mx -Mz / minN		-2705.1	-942.8	165.8	96.0	289.2	
		-Mx -Mz / minN		2705.1	942.8	165.8	96.0	289.2	
+-----+									
	6-base	+Mx +Mz / maxN		-4959.4	-942.8	-442.4	-94.9	289.2	
		-Mx +Mz / maxN		4959.4	942.8	-442.4	-94.9	289.2	
		+Mx -Mz / maxN		-4959.4	-942.8	439.1	96.0	289.2	
		-Mx -Mz / maxN		4959.4	942.8	439.1	96.0	289.2	
		+Mx +Mz / minN		-4959.4	-942.8	-442.4	-94.9	289.2	
		-Mx +Mz / minN		4959.4	942.8	-442.4	-94.9	289.2	
		+Mx -Mz / minN		-4959.4	-942.8	439.1	96.0	289.2	
		-Mx -Mz / minN		4959.4	942.8	439.1	96.0	289.2	
+-----+									
	5-base	+Mx +Mz / maxN		-7213.7	-687.5	-719.2	-112.7	578.5	
		-Mx +Mz / maxN		7213.7	687.5	-719.2	-112.7	578.5	
		+Mx -Mz / maxN		-7213.7	-687.5	713.1	113.6	578.5	
		-Mx -Mz / maxN		7213.7	687.5	713.1	113.6	578.5	
		+Mx +Mz / minN		-7213.7	-687.5	-719.2	-112.7	578.5	
		-Mx +Mz / minN		7213.7	687.5	-719.2	-112.7	578.5	
		+Mx -Mz / minN		-7213.7	-687.5	713.1	113.6	578.5	
		-Mx -Mz / minN		7213.7	687.5	713.1	113.6	578.5	
+-----+									
	4-base	+Mx +Mz / maxN		-9468.0	-1003.2	-996.4	-156.4	867.7	
		-Mx +Mz / maxN		9468.0	1003.2	-996.4	-156.4	867.7	
		+Mx -Mz / maxN		-9468.0	-1003.2	986.9	157.5	867.7	
		-Mx -Mz / maxN		9468.0	1003.2	986.9	157.5	867.7	
		+Mx +Mz / minN		-9468.0	-1003.2	-996.4	-156.4	867.7	
		-Mx +Mz / minN		9468.0	1003.2	-996.4	-156.4	867.7	
		+Mx -Mz / minN		-9468.0	-1003.2	986.9	157.5	867.7	
		-Mx -Mz / minN		9468.0	1003.2	986.9	157.5	867.7	
+-----+									
	3-base	+Mx +Mz / maxN		-11722.3	-1465.4	-1273.8	-216.3	1156.9	
		-Mx +Mz / maxN		11722.3	1465.4	-1273.8	-216.3	1156.9	
		+Mx -Mz / maxN		-11722.3	-1465.4	1260.4	217.6	1156.9	
		-Mx -Mz / maxN		11722.3	1465.4	1260.4	217.6	1156.9	
		+Mx +Mz / minN		-11722.3	-1465.4	-1273.8	-216.3	1156.9	
		-Mx +Mz / minN		11722.3	1465.4	-1273.8	-216.3	1156.9	
		+Mx -Mz / minN		-11722.3	-1465.4	1260.4	217.6	1156.9	
		-Mx -Mz / minN		11722.3	1465.4	1260.4	217.6	1156.9	

		+Mx -Mz / minN		-8566.3	0.0	523.4	0.2	2355.7	
		-Mx -Mz / minN		8566.3	0.0	523.4	0.2	2355.7	

DESIGN IN SHEAR W/O SHORT-SHEAR-SPAN EFFECTS (Web diagonal compression/tension)

Storey and location	Magn. factor	Design shear maxVED	Horizontal bars dia. max./provided	legs	spacing-sh	strut angle	Resistance VR,s	Resistance VR,max	
		(kN)	(mm)		(mm)	(deg)	(kN)	(kN)	
6 WEB	1.5	942	8	2	200	200	22	1573.5	2234.5
6 FLANGES	1.5	96	8	2x 2	200	200	22	1573.5	2234.5
5 WEB	1.5	687	8	2	200	200	22	1573.5	2234.5
5 FLANGES	1.5	113	8	2x 2	200	200	22	1573.5	2234.5
4 WEB	1.5	1003	8	2	200	200	22	1573.5	2234.5
4 FLANGES	1.5	157	8	2x 2	200	200	22	1573.5	2234.5
3 WEB	1.5	1465	8	2	200	200	22	1573.5	2234.5
3 FLANGES	1.5	217	8	2x 2	200	200	22	1573.5	2234.5
2 WEB	1.5	2070	8	2	200	150	22	2098.0	2234.5
2 FLANGES	1.5	296	8	2x 2	200	150	22	1573.5	2234.5
1 WEB	1.5	2695	10	2	250	135	28	2705.3	2705.3
1 FLANGES	1.5	197	10	2x 2	250	135	22	1966.9	2234.5
0 WEB	1.5	3073	10	2	250	85	37	3104.9	3104.9
0 FLANGES	1.5	562	10	2x 2	250	85	22	1966.9	2234.5
-1 WEB	1.5	2617	10	2	250	145	27	2636.3	2636.3
-1 FLANGES	1.5	319	10	2x 2	250	145	22	1966.9	2234.5

VERTICAL / HORIZONTAL / HOOP REINFORCEMENT (Story and base of above)

STO	Location	Dimensions (m)	Vert. dia #	Hoops dia s	Req	Prov	WEB dia sv	Horiz. dia sh	Joint Reinf
			(mm)	(mm)			(mm)	(mm)	(mm2)
6	CORNERS	0.25X.25	18 4	8 110	0.00	0.30	WEB 8 200	8 200	0
6	EDGES	0.15X.25	18 4	8 110	0.00	0.43	FLG 8 200	8 200	
5	CORNERS	0.25X.25	20 4	8 110	0.00	0.30	WEB 8 200	8 200	0
5	EDGES	0.15X.25	20 4	8 110	0.00	0.43	FLG 8 200	8 200	
4	CORNERS	0.25X.25	20 5	8 110	0.00	0.30	WEB 8 200	8 200	0
4	EDGES	0.15X.25	20 5	8 110	0.00	0.26	FLG 8 200	8 200	

3	CORNERS	0.25X.25	20 7	8 110 0.00 0.37	WEB	8 200	8 200	0
	EDGES	0.25X.25	20 7	8 110 0.00 0.26	FLG	8 200	8 200	
+-----+-----+-----+-----+-----+-----+-----+-----+								
2	CORNERS	0.35X.25-0.35X.25	20 12	8 110 0.00 0.22	WEB	8 200	8 150	0
	EDGES	0.35X.25	20 12	8 110 0.00 0.24	FLG	8 200	8 200	
+-----+-----+-----+-----+-----+-----+-----+-----+								
1	CORNERS	0.40X.25-0.55X.25	20 12	8 110 0.00 0.22	WEB	8 200	10 135	0
	EDGES	0.40X.25	20 12	8 110 0.00 0.24	FLG	8 200	10 250	
+-----+-----+-----+-----+-----+-----+-----+-----+								
0	CORNERS	0.40X.25-0.55X.25	20 12	8 110 0.00 0.22	WEB	8 200	10 85	0
	EDGES	0.40X.25	20 12	8 110 0.00 0.24	FLG	8 200	10 250	
+-----+-----+-----+-----+-----+-----+-----+-----+								
-1	CORNERS	0.40X.25-0.55X.25	20 12	8 110 0.00 0.22	WEB	8 200	10 145	0
	EDGES	0.40X.25	20 12	8 110 0.00 0.24	FLG	8 200	10 250	
+-----+-----+-----+-----+-----+-----+-----+-----+								
-2	CORNERS	0.40X.25-0.55X.25	20 12	8 110 0.00 0.22	WEB	8 200	10 145	0
	EDGES	0.40X.25	20 12	8 110 0.00 0.24	FLG	8 200	10 250	
+-----+-----+-----+-----+-----+-----+-----+-----+								

3A 5. DESIGN OF FOUNDATION ELEMENTS

3A 5.1. FOOTING F7

+-----+-----+-----+-----+-----+-----+-----+-----+									
FOOTING OF COLUMN : 7									
Undr. shear strength in seismic design situation: 270kPa in Eqs.6.10a/b: 300kPa									
Friction angle & cohesion under drained conditions for Eqs.6.10a/b: 20deg,50kPa									
+-----+-----+-----+-----+-----+-----+-----+-----+									
footing depth h(m): 0.80 footing plan dimension(m): //y by= 2.00 //z bz= 2.00									
found. depth (m): 0.80 column X-sect.dimensions(m): //y cy=0.50 //z cz=0.50									
column axis eccentricity(m): //y ay=0.00 //z az=0.00									
+-----+-----+-----+-----+-----+-----+-----+-----+									
FOUNDATION DESIGN FORCES AT FOOTING CENTRE - SOIL BEARING PRESSURE & CAPACITY									
+-----+-----+-----+-----+-----+-----+-----+-----+									
	Combination	Cap-Des	N	My ey/by	Vy	Mz ez/bz	Vz	Soil Bearing	
	of Actions	magnif.	total					press./capacity	
+-----+-----+-----+-----+-----+-----+-----+-----+									
	EN1990 Eq. 6.10a*	-	4207	-1 0.000	0	0 0.000	0	1052.4/1284.5	
	EN1990 Eq. 6.10b*	-	3975	-1 0.000	0	0 0.000	0	994.3/1284.5	
	G+ψ2Q+E +X/+Y/max	3.000	2861	21 0.005	9	27 0.004	11	728.0/1686.0	
+-----+-----+-----+-----+-----+-----+-----+-----+									

G+ψ2Q+E -X/+Y/max	2.909		2859	25	0.005	12	26	0.004	11	728.3/1686.1
G+ψ2Q+E +X/-Y/max	3.000		2861	21	0.005	9	28	0.004	11	728.2/1685.9
G+ψ2Q+E -X/-Y/max	2.909		2859	25	0.005	12	27	0.004	11	728.4/1686.0
G+ψ2Q+E +X/+Y/min	3.000		2744	21	0.005	9	27	0.004	11	698.8/1686.0
G+ψ2Q+E -X/+Y/min	2.930		2746	25	0.005	12	27	0.005	11	699.9/1686.1
G+ψ2Q+E +X/-Y/min	3.000		2744	21	0.005	9	28	0.004	11	698.9/1685.9
G+ψ2Q+E -X/-Y/min	2.930		2746	25	0.005	12	27	0.005	11	700.0/1686.0

*Note: The most unfavourable outcome of the application of 6.10a/6.10b applies.

ULS DESIGN OF FOOTING IN SHEAR & PUNCHING SHEAR

Combination of Actions	Shear stress vEd sect.//y	Shear sect.//z	Resist. vRd,c	Punching shear at distance av max stress	av: crit. distance	Resistance (2d/av)vRd
	vEdy/bzd	VEDz/byd		maxvEd	(m)	(kPa)
EN1990 Eq. 6.10a*	16.8	16.8	328.1	576.9	0.5	1009.6
EN1990 Eq. 6.10b*	15.9	15.8	328.1	544.4	0.5	1009.6
G+ψ2Q+E +X/+Y/max	11.6	11.6	328.1	393.4	0.5	1009.6
G+ψ2Q+E -X/+Y/max	11.6	11.6	328.1	393.4	0.5	1009.6
G+ψ2Q+E +X/-Y/max	11.6	11.7	328.1	393.5	0.5	1009.6
G+ψ2Q+E -X/-Y/max	11.6	11.6	328.1	393.5	0.5	1009.6
G+ψ2Q+E +X/+Y/min	11.1	11.2	328.1	377.1	0.5	1009.6
G+ψ2Q+E -X/+Y/min	11.1	11.2	328.1	377.5	0.5	1009.6
G+ψ2Q+E +X/-Y/min	11.1	11.2	328.1	377.1	0.5	1009.6
G+ψ2Q+E -X/-Y/min	11.1	11.2	328.1	377.6	0.5	1009.6

*Note: The most unfavourable outcome of the application of 6.10a/6.10b applies.

ULS DESIGN OF TWO-WAY REINFORCEMENT AT FOOTING BOTTOM

Maximum bending moments				Reinforcement				
Vert. section //bz	Vert. section //by	Bar dia.	//by	//bz	spacing	No.	spacing	No.
MEdy/bz	MEdz/by	Combinat.	Combinat.					
(kNm/m)	(kNm/m)			(mm)	(mm)		(mm)	
286.8	1	286.5	1	12	110	18	110	18

3A 5.2. FOOTING F8

```

+-----+
FOOTING OF COLUMN :      8
Undr. shear strength in seismic design situation: 270kPa in Eqs.6.10a/b: 300kPa
Friction angle & cohesion under drained conditions for Eqs.6.10a/b: 20deg,50kPa
+-----+
|footing depth h(m): 0.80|footing plan dimension(m): //y by= 1.80 //z bz= 1.80|
|found. depth (m): 0.80 |column X-sect.dimensions(m): //y cy=0.50 //z cz=0.50|
|
|column axis eccentricity(m): //y ay=0.00 //z az=0.00|
+-----+

```

FOUNDATION DESIGN FORCES AT FOOTING CENTRE - SOIL BEARING PRESSURE & CAPACITY

Combination of Actions	Cap-Des magnif.	N total	My (kNm)	ey/by	Vy (kN)	Mz (kNm)	ez/bz	Vz (kN)	Soil Bearing press./capacity
EN1990 Eq. 6.10a*	-	2734	17	0.000	0	0	0.004	0	850.4/1236.4
EN1990 Eq. 6.10b*	-	2574	17	0.000	0	0	0.004	0	800.6/1236.3
G+ψ2Q+E +X/+Y/max	3.000	2549	52	0.006	27	26	0.011	10	814.8/1671.1
G+ψ2Q+E -X/+Y/max	3.000	2549	9	0.006	2	26	0.002	10	799.3/1679.1
G+ψ2Q+E +X/-Y/max	3.000	2549	52	0.006	27	27	0.011	11	815.0/1671.2
G+ψ2Q+E -X/-Y/max	3.000	2549	9	0.006	2	27	0.002	11	799.6/1678.8
G+ψ2Q+E +X/+Y/min	3.000	1109	52	0.013	27	26	0.026	10	371.3/1666.3
G+ψ2Q+E -X/+Y/min	3.000	1109	9	0.013	2	26	0.005	10	355.1/1676.3
G+ψ2Q+E +X/-Y/min	3.000	1109	52	0.014	27	27	0.026	11	371.6/1666.5
G+ψ2Q+E -X/-Y/min	3.000	1109	9	0.014	2	27	0.005	11	355.3/1675.9

*Note: The most unfavourable outcome of the application of 6.10a/6.10b applies.

ULS DESIGN OF FOOTING IN SHEAR & PUNCHING SHEAR

Combination of Actions	Shear stress vEd sect.//y vEdy/bzd	Shear stress vEd sect.//z VEdz/byd	Shear Resist. vRd,c	Punching shear max stress maxvEd	av: crit. distance (2d/av)	Resistance vRd
EN1990 Eq. 6.10a*	0.0	0.0	328.1	293.6	0.5	1009.6
EN1990 Eq. 6.10b*	0.0	0.0	328.1	276.0	0.5	1009.6
G+ψ2Q+E +X/+Y/max	0.0	0.0	328.1	278.7	0.5	1009.6
G+ψ2Q+E -X/+Y/max	0.0	0.0	328.1	274.7	0.5	1009.6
G+ψ2Q+E +X/-Y/max	0.0	0.0	328.1	278.7	0.5	1009.6
G+ψ2Q+E -X/-Y/max	0.0	0.0	328.1	274.8	0.5	1009.6
G+ψ2Q+E +X/+Y/min	0.0	0.0	328.1	121.6	0.5	1009.6

G+ψ2Q+E -X/+Y/min	0.0	0.0	328.1	117.6	0.5	1009.6
G+ψ2Q+E +X/-Y/min	0.0	0.0	328.1	121.7	0.5	1009.6
G+ψ2Q+E -X/-Y/min	0.0	0.0	328.1	117.7	0.5	1009.6

-----+

*Note: The most unfavourable outcome of the application of 6.10a/6.10b applies.

-----+

ULS DESIGN OF TWO-WAY REINFORCEMENT AT FOOTING BOTTOM

-----+

Maximum bending moments				Reinforcement			
Vert. section //bz		Vert. section //by		Bar dia.	//by	//bz	
MEdy/bz	Combinat.	MEdz/by	Combinat.	spacing	No.	spacing	No.
+- (kNm/m) -----+-		+- (kNm/m) -----+-		(mm) ---	(mm) -----	(mm) -----	
173.8	1	170.9	1	12	150	11	150 11

-----+

3A 5.3. FOOTING F12

-----+

FOOTING OF COLUMN : 12

Undr. shear strength in seismic design situation: 270kPa in Eqs.6.10a/b: 300kPa

Friction angle & cohesion under drained conditions for Eqs.6.10a/b: 20deg,50kPa

-----+

|footing depth h(m): 0.80|footing plan dimension(m): //y by= 2.00 //z bz= 1.50|

|found. depth (m): 0.80 |column X-sect.dimensions(m): //y cy=0.70 //z cz=0.30|

| |column axis eccentricity(m): //y ay=0.00 //z az=0.00|

-----+

FOUNDATION DESIGN FORCES AT FOOTING CENTRE - SOIL BEARING PRESSURE & CAPACITY

-----+

Combination of Actions	Cap-Des magnif.	N total	My (kNm)	ey/by	Vy (kN)	Mz (kNm)	ez/bz	Vz (kN)	Soil Bearing press./capacity
-----+		-(kN) -	-(kNm) -----		-(kN) -	-(kNm) -----		-(kN) -----	(kPa) -----
EN1990 Eq. 6.10a*	-	2694	0	0.000	0	-1	0.000	0	898.6/1150.8
EN1990 Eq. 6.10b*	-	2538	0	0.000	0	-1	0.000	0	846.6/1150.8
G+ψ2Q+E +X/+Y/max	3.000	2241	55	0.005	27	15	0.012	5	773.4/1607.3
G+ψ2Q+E -X/+Y/max	3.000	2241	56	0.005	27	15	0.013	5	773.5/1607.2
G+ψ2Q+E +X/-Y/max	2.079	2105	38	0.004	18	13	0.009	5	721.1/1610.2
G+ψ2Q+E -X/-Y/max	2.079	2105	38	0.004	18	13	0.009	5	721.2/1610.1
G+ψ2Q+E +X/+Y/min	3.000	1359	55	0.008	27	15	0.020	5	480.1/1609.2
G+ψ2Q+E -X/+Y/min	3.000	1359	56	0.008	27	15	0.021	5	480.2/1609.1
G+ψ2Q+E +X/-Y/min	1.906	1520	35	0.005	17	12	0.012	4	524.5/1611.4

|G+ψ2Q+E -X/-Y/min| 1.906 | 1520 35 0.005 17 12 0.012 4 524.6/1611.4|

+-----+

*Note: The most unfavourable outcome of the application of 6.10a/6.10b applies.

+-----+

ULS DESIGN OF FOOTING IN SHEAR & PUNCHING SHEAR

+-----+

Combination of Actions	Shear stress vEd		Shear Resist. vRd,c	Punching shear at distance av	
	sect.//y vEdy/bzd	sect.//z VEdz/byd		max stress maxvEd	av: crit. distance (2d/av)

+-----+----- (kPa) -----+----- (kPa) -+---- (kPa) --+---- (m) -----+---- (kPa) --+

EN1990 Eq. 6.10a*	0.0	0.0	328.1	263.0	0.5	1009.6
EN1990 Eq. 6.10b*	0.0	0.0	328.1	247.4	0.5	1009.6
G+ψ2Q+E +X/+Y/max	0.0	0.0	328.1	224.6	0.5	1009.6
G+ψ2Q+E -X/+Y/max	0.0	0.0	328.1	224.7	0.5	1009.6
G+ψ2Q+E +X/-Y/max	0.0	0.0	328.1	209.1	0.5	1009.6
G+ψ2Q+E -X/-Y/max	0.0	0.0	328.1	209.1	0.5	1009.6
G+ψ2Q+E +X/+Y/min	0.0	0.0	328.1	136.7	0.5	1009.6
G+ψ2Q+E -X/+Y/min	0.0	0.0	328.1	136.7	0.5	1009.6
G+ψ2Q+E +X/-Y/min	0.0	0.0	328.1	150.3	0.5	1009.6
G+ψ2Q+E -X/-Y/min	0.0	0.0	328.1	150.3	0.5	1009.6

+-----+

*Note: The most unfavourable outcome of the application of 6.10a/6.10b applies.

+-----+

ULS DESIGN OF TWO-WAY REINFORCEMENT AT FOOTING BOTTOM

+-----+

Maximum bending moments				Reinforcement			
Vert. section //bz		Vert. section //by		Bar dia.	//by		//bz
MEdy/bz	Combinat.	MEdz/by	Combinat.	spacing	No.	spacing	No.

+-- (kNm/m) -----+-- (kNm/m) -----+-- (mm) --+---- (mm) -----+---- (mm) -----+

181.0	1	156.5	1	12	150 10	150	13
-------	---	-------	---	----	--------	-----	----

+-----+

3A 5.4. FOOTING F13

+-----+

FOOTING OF COLUMN : 13

Undr. shear strength in seismic design situation: 270kPa in Eqs.6.10a/b: 300kPa

Friction angle & cohesion under drained conditions for Eqs.6.10a/b: 20deg, 50kPa

+-----+

|footing depth h(m): 0.80|footing plan dimension(m): //y by= 2.00 //z bz= 1.50|

|found. depth (m): 0.80 |column X-sect.dimensions(m): //y cy=0.70 //z cz=0.30|
 | |column axis eccentricity(m): //y ay=0.00 //z az=0.00|

+-----+

FOUNDATION DESIGN FORCES AT FOOTING CENTRE - SOIL BEARING PRESSURE & CAPACITY

+-----+

Combination of Actions	Cap-Des magnif.	N total	My	ey/by	Vy	Mz	ez/bz	Vz	Soil Bearing press./capacity
		(kN)	(kNm)		(kN)	(kNm)		(kN)	(kPa)
EN1990 Eq. 6.10a*	-	2348	0	0.002	0	6	0.000	0	785.6/1149.9
EN1990 Eq. 6.10b*	-	2208	0	0.002	0	6	0.000	0	738.9/1149.9
G+ψ2Q+E +X/+Y/max	3.000	1956	53	0.012	25	36	0.014	25	687.2/1603.6
G+ψ2Q+E -X/+Y/max	3.000	1956	52	0.012	25	36	0.014	25	687.1/1603.6
G+ψ2Q+E +X/-Y/max	2.479	1889	43	0.008	21	22	0.012	21	655.1/1607.2
G+ψ2Q+E -X/-Y/max	2.479	1889	43	0.008	21	22	0.012	21	655.0/1607.2
G+ψ2Q+E +X/+Y/min	3.000	1187	53	0.020	25	36	0.022	25	432.1/1603.4
G+ψ2Q+E -X/+Y/min	3.000	1187	52	0.020	25	36	0.022	25	431.9/1603.4
G+ψ2Q+E +X/-Y/min	2.283	1279	40	0.010	19	20	0.016	19	449.9/1608.6
G+ψ2Q+E -X/-Y/min	2.283	1279	40	0.010	19	20	0.016	19	449.8/1608.6

+-----+

*Note: The most unfavourable outcome of the application of 6.10a/6.10b applies.

+-----+

ULS DESIGN OF FOOTING IN SHEAR & PUNCHING SHEAR

+-----+

Combination of Actions	Shear stress vEd sect.//y	Shear stress vEd sect.//z	Shear Resist. vRd,c	Punching shear at distance av max stress	Punching shear at distance av crit. Resistance
	(kPa)	(kPa)	(kPa)	(kPa)	(m)
EN1990 Eq. 6.10a*	0.0	0.0	328.1	229.2	0.5
EN1990 Eq. 6.10b*	0.0	0.0	328.1	215.2	0.5
G+ψ2Q+E +X/+Y/max	0.0	0.0	328.1	197.2	0.5
G+ψ2Q+E -X/+Y/max	0.0	0.0	328.1	197.2	0.5
G+ψ2Q+E +X/-Y/max	0.0	0.0	328.1	188.6	0.5
G+ψ2Q+E -X/-Y/max	0.0	0.0	328.1	188.6	0.5
G+ψ2Q+E +X/+Y/min	0.0	0.0	328.1	120.6	0.5
G+ψ2Q+E -X/+Y/min	0.0	0.0	328.1	120.6	0.5
G+ψ2Q+E +X/-Y/min	0.0	0.0	328.1	127.3	0.5
G+ψ2Q+E -X/-Y/min	0.0	0.0	328.1	127.2	0.5

+-----+

*Note: The most unfavourable outcome of the application of 6.10a/6.10b applies.

+-----+

ULS DESIGN OF TWO-WAY REINFORCEMENT AT FOOTING BOTTOM

+-----+

Maximum bending moments				Reinforcement			
Vert. section //bz		Vert. section //by		Bar dia.	//by		//bz
MEdy/bz	Combinat.	MEdz/by	Combinat.	spacing	No.	spacing	No.
+- (kNm/m)	-----	+- (kNm/m)	-----	--- (mm)	--- (mm)	-----	--- (mm)
156.6	1	136.6	1	12	150 10	150	13

3A 5.5. FOOTING OF WALL W5

Undr. shear strength in seismic design situation: 270kPa in Eqs.6.10a/b: 300kPa
Friction angle & cohesion under drained conditions for Eqs.6.10a/b: 20deg, 50kPa

footing depth h(m): 0.80		Footing plan dimension(m): //y by=4.50 //z bz=2.50					
found. depth (m): 0.80		Member section outline(m): //y cy=3.60 //z cz=1.80					
		Member axis eccentricity(m): //y ay=0.00 //z az=0.00					

FOUNDATION DESIGN FORCES AT FOOTING CENTRE - SOIL BEARING PRESSURE & CAPACITY

Combination of Actions	Cap-Des magnif.	N total	My (kNm)	ey/by	Vy (kN)	Mz (kNm)	ez/bz	Vz (kN)	Soil Bearing press./capacity (kPa)
EN1990 Eq. 6.10a*	-	3700	0	0.000	0	0	0.000	0	329.0/1738.9
EN1990 Eq. 6.10b*	-	3349	0	0.000	0	0	0.000	0	297.8/1738.9
G+ψ2Q+E+X/+Y/maxN	1.114	4936	4104	0.185	694	208	0.017	71	720.3/1649.6
G+ψ2Q+E-X/+Y/maxN	1.114	4936	4104	0.185	694	208	0.017	71	720.3/1649.6
G+ψ2Q+E+X/-Y/maxN	1.114	4936	4104	0.185	694	207	0.017	72	720.3/1649.7
G+ψ2Q+E-X/-Y/maxN	1.114	4936	4104	0.185	694	207	0.017	72	720.3/1649.7
G+ψ2Q+E+X/+Y/minN	1.114	4936	4104	0.185	694	208	0.017	71	720.3/1649.6
G+ψ2Q+E-X/+Y/minN	1.114	4936	4104	0.185	694	208	0.017	71	720.3/1649.6
G+ψ2Q+E+X/-Y/minN	1.114	4936	4104	0.185	694	207	0.017	72	720.3/1649.7
G+ψ2Q+E-X/-Y/minN	1.114	4936	4104	0.185	694	207	0.017	72	720.3/1649.7

*Note: The most unfavourable outcome of the application of 6.10a/6.10b applies.

ULS DESIGN OF FOOTING IN SHEAR & PUNCHING SHEAR

Combination of Actions	Shear stress vEd sect.//y	Shear stress vEd sect.//z	Resist. vRd,c	Punching shear max stress	av: crit. distance	Resistance (2d/av)vRd
	vEdy/bzd	vEdz/byd	vRd,c	max vEd	distance	(2d/av)vRd
	-----	-----	-----	-----	-----	-----
	(kPa)	(kPa)	(kPa)	(kPa)	(m)	(kPa)

EN1990 Eq. 6.10a*	0.0	0.0	328.1	0.0	0.4	0.0
EN1990 Eq. 6.10b*	0.0	0.0	328.1	0.0	0.4	0.0
G+ψ2Q+E+X/+Y/maxN	0.0	0.0	328.1	0.0	0.4	0.0
G+ψ2Q+E-X/+Y/maxN	0.0	0.0	328.1	0.0	0.4	0.0
G+ψ2Q+E+X/-Y/maxN	0.0	0.0	328.1	0.0	0.4	0.0
G+ψ2Q+E-X/-Y/maxN	0.0	0.0	328.1	0.0	0.4	0.0
G+ψ2Q+E+X/+Y/minN	0.0	0.0	328.1	0.0	0.4	0.0
G+ψ2Q+E-X/+Y/minN	0.0	0.0	328.1	0.0	0.4	0.0
G+ψ2Q+E+X/-Y/minN	0.0	0.0	328.1	0.0	0.4	0.0
G+ψ2Q+E-X/-Y/minN	0.0	0.0	328.1	0.0	0.4	0.0

*Note: The most unfavourable outcome of the application of 6.10a/6.10b applies.

ULS DESIGN OF TWO-WAY REINFORCEMENT AT FOOTING BOTTOM

Maximum bending moments				Reinforcement			
Vert. section //bz		Vert. section //by		Bar dia.	//by		//bz
MEdy/bz	Combinat.	MEdz/by	Combinat.	spacing	No.	spacing	No.
+- (kNm/m)		+- (kNm/m)		--- (mm)	--- (mm)	--- (mm)	---
72.4	10	21.8	8	12	150 16	150	30

3A 5.6. COMMON FOOTING OF WALLS W3 AND W4

Undr. shear strength in seismic design situation: 270kPa in Eqs.6.10a/b: 300kPa
Friction angle & cohesion under drained conditions for Eqs.6.10a/b: 20deg, 50kPa

footing depth h(m): 1.00	Footing plan dimension(m): //y by=4.00 //z bz=5.00
found. depth (m): 1.00	Member section outline(m): //y cy=3.60 //z cz=4.00
	Member axis eccentricity(m): //y ay=0.00 //z az=0.00

FOUNDATION DESIGN FORCES AT FOOTING CENTRE - SOIL BEARING PRESSURE & CAPACITY

Combination of Actions	Cap-Des magnif.	N total	My ey/by	Vy	Mz ez/bz	Vz	Soil Bearing press./capacity
-----	-----	+- (kN)	-(kNm)	----- (kN)	-(kNm)	----- (kN)	----- (kPa)
EN1990 Eq. 6.10a*	-	5280	0 0.000	0	4 0.000	2	264.1/1814.4
EN1990 Eq. 6.10b*	-	4790	0 0.000	0	4 0.000	2	239.6/1814.4
G+ψ2Q+E+X/+Y/maxN	2.155	3674	79 0.005	36	2629 0.143	265	260.3/1663.7
G+ψ2Q+E-X/+Y/maxN	2.155	3674	79 0.005	36	2629 0.143	265	260.3/1663.7

G+ψ2Q+E+X/-Y/maxN	2.182	3674	80	0.006	37	2668	0.145	265	261.9/1662.2
G+ψ2Q+E-X/-Y/maxN	2.182	3674	80	0.006	37	2668	0.145	265	261.9/1662.2
G+ψ2Q+E+X/+Y/minN	2.155	3674	79	0.005	36	2629	0.143	265	260.3/1663.7
G+ψ2Q+E-X/+Y/minN	2.155	3674	79	0.005	36	2629	0.143	265	260.3/1663.7
G+ψ2Q+E+X/-Y/minN	2.182	3674	80	0.006	37	2668	0.145	265	261.9/1662.2
G+ψ2Q+E-X/-Y/minN	2.182	3674	80	0.006	37	2668	0.145	265	261.9/1662.2

+-----+
*Note: The most unfavourable outcome of the application of 6.10a/6.10b applies.
+-----+

ULS DESIGN OF FOOTING IN SHEAR & PUNCHING SHEAR

Combination of Actions	Shear stress vEd		Shear Resist.	Punching shear at distance av		
	sect.//y vEdy/bzd	sect.//z vEdz/byd		max stress maxvEd	av: crit. distance	Resistance (2d/av)vRd
	+-----+ (kPa) -----+ (kPa) -----+ (kPa) -----+ (m) -----+ (kPa) -----+					
EN1990 Eq. 6.10a*	0.0	0.0	309.3	0.0	0.5	0.0
EN1990 Eq. 6.10b*	0.0	0.0	309.3	0.0	0.5	0.0
G+ψ2Q+E+X/+Y/maxN	0.0	0.0	309.3	0.0	0.5	0.0
G+ψ2Q+E-X/+Y/maxN	0.0	0.0	309.3	0.0	0.5	0.0
G+ψ2Q+E+X/-Y/maxN	0.0	0.0	309.3	0.0	0.5	0.0
G+ψ2Q+E-X/-Y/maxN	0.0	0.0	309.3	0.0	0.5	0.0
G+ψ2Q+E+X/+Y/minN	0.0	0.0	309.3	0.0	0.5	0.0
G+ψ2Q+E-X/+Y/minN	0.0	0.0	309.3	0.0	0.5	0.0
G+ψ2Q+E+X/-Y/minN	0.0	0.0	309.3	0.0	0.5	0.0
G+ψ2Q+E-X/-Y/minN	0.0	0.0	309.3	0.0	0.5	0.0

+-----+
*Note: The most unfavourable outcome of the application of 6.10a/6.10b applies.
+-----+

ULS DESIGN OF TWO-WAY REINFORCEMENT AT FOOTING BOTTOM

Maximum bending moments				Reinforcement					
Vert. section //bz		Vert. section //by		Bar dia.	//by		//bz		
ME _{dy} /bz	Combinat.	ME _{dz} /by	Combinat.		spacing	No.	spacing	No.	
+-----+ (kNm/m) -----+ (kNm/m) -----+ (mm) -----+ (mm) -----+ (mm) -----+									
0.0	0	13.5	10	12	150	33	150	26	

European Commission

EUR 25204 EN – Joint Research Centre

Title: Eurocode 8: Seismic Design of Buildings. Worked Examples

Author(s): P. Bisch, E. Carvalho, H. Degee, P. Fajfar, M. Fardis, P. Franchin, M. Kreslin, A. Pecker, P. Pinto, A. Plumier, H. Somja, G. Tsionis

Luxembourg: Publications Office of the European Union
2012 – 515 pp. – 21 x 29.7 cm
EUR – Scientific and Technical Research series – ISSN 1831-9424
ISBN 978-92-79-23068-4
doi:10.2788/91658

Abstract

This document is a Technical Report with worked examples for seismic design of buildings following the Eurocodes. It summarizes important points of the Eurocode 8 for the seismic design of concrete and steel buildings including foundations utilizing a common generic building as a basis.

An overview of EN 1998 is presented at the first section with focus on the performance requirements and compliance criteria for structures, ground conditions and seismic actions. An introduction to the example reinforced concrete building with its geometrical and material properties as well as the main assumptions for analysis and the detailed structural analysis calculations are presented in the second chapter. Specific rules for design of the building for ductility and the design of concrete foundation elements are presented in the following chapters. For the sake of completeness, the details of design and detailing of the same example as a steel building with three different configurations, namely; with (i) steel moment resisting frames, (ii) composite steel concrete moment resisting frames, and (iii) composite steel concrete frames with eccentric and concentric bracings is also presented. Key concepts of base isolation are summarized by utilizing the example building. Seismic performance assessment and retrofitting according to EN 1998-Part 3 is explained in the last part of the report.

The reinforced concrete/steel building (worked example) analyzed in this report was prepared and presented at the workshop “Eurocode 8: Seismic Design of Buildings” that was held on 10-11 February 2011 in Lisbon, Portugal. The workshop was organized by JRC with the support of DG ENTR and CEN and in collaboration with CEN/TC250/Sub-Committee 8 and the National Laboratory for Civil Engineering (Laboratorio Nacional de Engenharia Civil - LNEC, Lisbon).

The document is part of the Report Series ‘Support to the implementation, harmonization and further development of the Eurocodes’ prepared by JRC in collaboration with DG ENTR and CEN/TC250 “Structural Eurocodes”.

How to obtain EU publications

Our priced publications are available from EU Bookshop (<http://bookshop.europa.eu>), where you can place an order with the sales agent of your choice.

The Publications Office has a worldwide network of sales agents. You can obtain their contact details by sending a fax to (352) 29 29-42758.

The mission of the JRC is to provide customer-driven scientific and technical support for the conception, development, implementation and monitoring of EU policies. As a service of the European Commission, the JRC functions as a reference centre of science and technology for the Union. Close to the policy-making process, it serves the common interest of the Member States, while being independent of special interests, whether private or national.

